



# OLS20-BB1114342

OLS

CONTRAST SENSORS

**SICK**  
Sensor Intelligence.



Illustration may differ



### Ordering information

Type	Part no.
OLS20-BB114342	1113053

Other models and accessories → [www.sick.com/OLS](http://www.sick.com/OLS)

### Detailed technical data

#### Features

<b>Dimensions (W x H x D)</b>	31 mm x 62 mm x 52.5 mm
<b>Sensing distance</b>	≤ 100 mm
<b>Sensing distance tolerance</b>	± 10 mm
<b>Housing design</b>	Rectangular
<b>Working range</b>	90 mm ... 110 mm
<b>Light source</b>	LED, blue <sup>1)</sup>
<b>Wave length</b>	450 nm
<b>Light spot size</b>	180 mm x 9 mm <sup>2)</sup>
<b>Receiving filters</b>	RG 610
<b>Bar code types</b>	2/5 Interleaved with checksum
<b>Module width (min.)</b>	≥ 1.5 mm
<b>Line radius (min.)</b>	≥ 0.5 m
<b>Track color</b>	Orange

<sup>1)</sup> Average service life: 100,000 h at T<sub>U</sub> = +25 °C.

<sup>2)</sup> Field of view line +90mm, field of view code +50mm.

#### Mechanics/electronics

<b>Supply voltage</b>	18 V DC ... 30 V DC <sup>1)</sup>
<b>Ripple</b>	≤ 5 V <sub>pp</sub> <sup>2)</sup>

<sup>1)</sup> Limit values when operated in short-circuit protected network: max. 8 A.

<sup>2)</sup> May not exceed or fall below U<sub>v</sub> tolerances.

<sup>3)</sup> Without load.

<b>Power consumption</b>	< 3 W <sup>3)</sup>
<b>Sampling rate</b>	5 ms
<b>Accuracy optical center</b>	± 1 mm
<b>Switching output</b>	Push-pull: PNP/NPN
<b>Switching output (voltage)</b>	Push-pull: PNP/NPN HIGH = $U_V - 3\text{ V}$ /LOW ≤ 3 V
<b>Output current I<sub>max.</sub></b>	< 100 mA
<b>Connection type</b>	Male connector M12, 5-pin
<b>Protection class</b>	III
<b>Circuit protection</b>	U <sub>V</sub> connections, reverse polarity protected Output Q short-circuit protected Interference pulse suppression
<b>Enclosure rating</b>	IP67
<b>LED risk group</b>	2 (IEC 62471)
<b>Weight</b>	250 g
<b>Housing material</b>	Zinc diecast

<sup>1)</sup> Limit values when operated in short-circuit protected network: max. 8 A.

<sup>2)</sup> May not exceed or fall below U<sub>V</sub> tolerances.

<sup>3)</sup> Without load.

### Communication interface

<b>IO-Link</b>	✓, COM3 (230,4 kBaud)
Cycle time	5 ms
Process data length	21 Byte Process Data In
<b>CANopen</b>	✓
<b>Digital output</b>	Q <sub>1</sub>
Number	1

### Ambient data

<b>Ambient operating temperature</b>	-10 °C ... +55 °C
<b>Ambient temperature, storage</b>	-25 °C ... +75 °C
<b>Ambient light immunity</b>	50,000 lx
<b>Shock load</b>	According to IEC 60068
<b>UL File No.</b>	NRKH.E181493 & NRKH7.E181493

### Classifications

<b>ECLASS 5.0</b>	27270906
<b>ECLASS 5.1.4</b>	27270906
<b>ECLASS 6.0</b>	27270906
<b>ECLASS 6.2</b>	27270906
<b>ECLASS 7.0</b>	27270906
<b>ECLASS 8.0</b>	27270906
<b>ECLASS 8.1</b>	27270906
<b>ECLASS 9.0</b>	27270906
<b>ECLASS 10.0</b>	27270906

<b>ECLASS 11.0</b>	27270906
<b>ECLASS 12.0</b>	27270906
<b>ETIM 5.0</b>	EC001820
<b>ETIM 6.0</b>	EC001820
<b>ETIM 7.0</b>	EC001820
<b>ETIM 8.0</b>	EC001820
<b>UNSPSC 16.0901</b>	39121528

### Dimensional drawing (Dimensions in mm (inch))

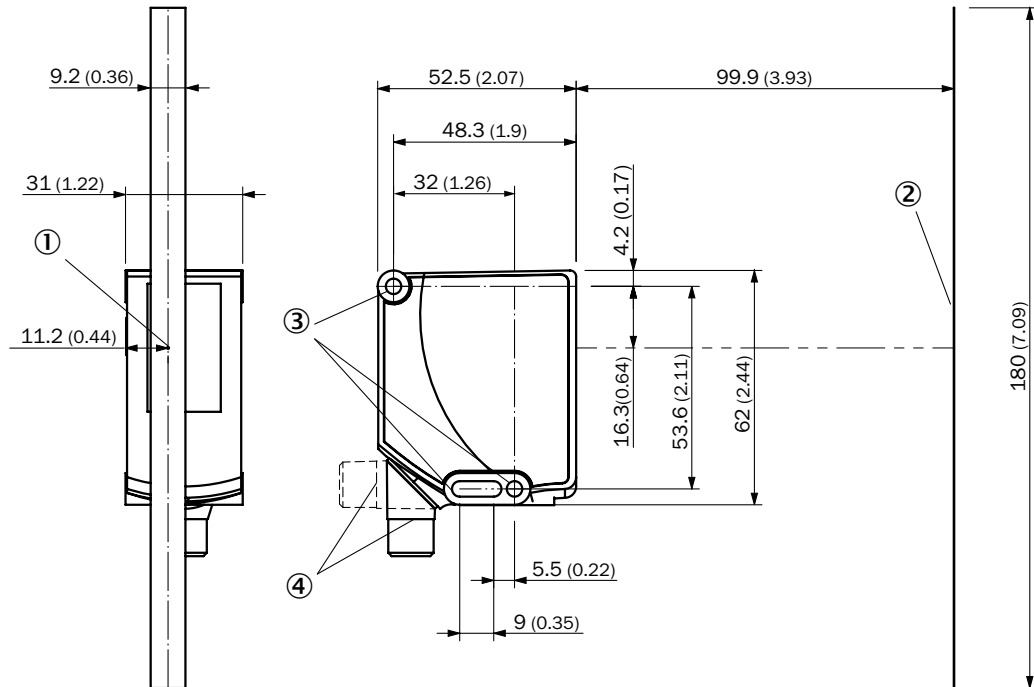

- ① Optical axis
- ② Field of view
- ③ Mounting hole,  $\varnothing$  4.1 mm
- ④ Connector M12 (rotatable up to 180°)

### Connection diagram

Cd-422

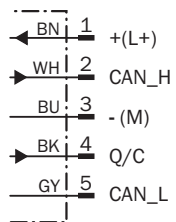



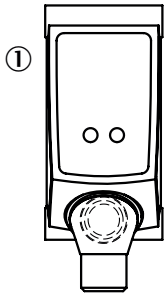



### Adjustments







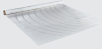

① Indicator lamps

### Recommended accessories

Other models and accessories → [www.sick.com/OLS](http://www.sick.com/OLS)

	Brief description	Type	Part no.
<b>Connection modules</b>			
	IO-Link V1.1 Class A port, USB2.0 port, optional external power supply 24V / 1A	IOLA2US-01101 (SiLink2 Master)	1061790
<b>Universal bar clamp systems</b>			
	Plate N04 for universal clamp, steel, Zinc plated steel (sheet), Zinc die cast (clamping bracket), Universal clamp (5322626), mounting hardware	BEF-KHS-N04	2051610
	Mounting bar, straight, 200 mm, steel, steel, zinc coated, without mounting hardware	BEF-MS12G-A	4056054
	Mounting bar, L-shaped, 250 x 250 mm, steel, steel, zinc coated, without mounting hardware	BEF-MS12L-B	4056053
<b>Codes</b>			
	Luminescent duct tape for easy application to all types of flooring, width 2.5 cm, length 25 m, neon orange	ADHESIVE TAPE, FABRIC	5337868
	1D bar codes in 2/5 interleaved format, set of 108 bar codes, 9 A4 sheets of 12 bar codes each, luminescent PVC base material with protective film, codes 0001 ... 0108, neon orange	BARCODE 7510-038-0001-0108	5338408
	1D bar codes in 2/5 interleaved format with 3 digits plus checksum, set of 108 bar codes, 12 A4 sheets of 9 bar codes each, luminescent PVC base material with protective film, codes 0001 ... 0108, neon orange	BARCODE 7510-038-0001-0108-N	5343612
	1D bar codes in 2/5 interleaved format with 3 digits plus checksum, set of 108 bar codes, 12 A4 sheets of 9 bar codes each, luminescent PVC base material with protective film, codes 0109 ... 0216, neon orange	BARCODE 7510-038-0109-0216-N	5343613
	Scope of delivery: 1 x 90° arc, protective film for adhesive tape, slip resistance class R10, protection against abrasion and moisture, prepared as 90° arc with a radius of 1,000 mm	TAPE 250AS-100-35	5338390

	Brief description	Type	Part no.
	Protective film for adhesive tape, slip resistance class R10, protection against abrasion and moisture, width 3,5 cm, length 50 m	TAPE 250AS-35-50	5338386
	Scope of delivery: 1 x 90° arc, protective film for adhesive tape, slip resistance class R10, protection against abrasion and moisture, prepared as 90° arc with a radius of 500 mm	TAPE 250AS-500-35	5338389
	Scope of delivery: 1 x 90° arc, luminescent rugged PVC adhesive tape, prepared as 90° arc with a radius of 1,000 mm, neon orange	TAPE 7510-038-1000	5338388
	Luminescent rugged PVC adhesive tape for easy application to all types of flooring, width 2 cm, length 25 m, neon orange	TAPE 7510-038-20-25	5338378
	Scope of delivery: 1 x 90° arc: luminescent rugged PVC adhesive tape, prepared as 90° arc with a radius of 500 mm, neon orange	TAPE 7510-038-500	5338387
	<ul style="list-style-type: none"> <li>• <b>Connection type head A:</b> Male connector, M12, 5-pin, straight, A-coded</li> <li>• <b>Description:</b> Unshielded, Head A: male connector, M12, 5-pin, straight, unshielded, for cable diameter 4 mm ... 6 mm Head B: -</li> <li>• <b>Connection systems:</b> Screw-type terminals</li> <li>• <b>Permitted cross-section:</b> ≤ 0.75 mm<sup>2</sup></li> <li>• <b>Note:</b> For field bus technology</li> </ul>	STE-1205-G	6022083
	<ul style="list-style-type: none"> <li>• <b>Connection type head A:</b> Female connector, M12, 5-pin, straight, A-coded</li> <li>• <b>Connection type head B:</b> Flying leads</li> <li>• <b>Signal type:</b> Sensor/actuator cable</li> <li>• <b>Cable:</b> 5 m, 5-wire, PVC</li> <li>• <b>Description:</b> Sensor/actuator cable, unshielded</li> <li>• <b>Application:</b> Zones with chemicals</li> </ul>	YF2A15-050VB5XLEAX	2096240

Recommended services

Additional services → [www.sick.com/OLS](http://www.sick.com/OLS)

	Type	Part no.
<p>Pre-configuration</p> <ul style="list-style-type: none"> <li>• <b>Product area:</b> OLS</li> <li>• <b>Voraussetzungen:</b> SOPAS ET file or sensor app which contains the necessary configuration and is coordinated to the customer application, Uploading of the configuration or the SOPAS ET file or sensor app</li> <li>• <b>Range of services:</b> Production and delivery of one or several personalized SICK products with the configuration uploaded by the customer and selected in the web ordering process</li> <li>• <b>Documentation:</b> Additional label on the SICK product and its packaging with the configuration name specified by the customer and a unique configuration ID</li> <li>• <b>Duration:</b> The delivery time of the pre-configured and customer-specific SICK product is identical, or in the case of temporary storage, a few days longer than with a standard SICK product</li> </ul>	Pre-configuration OLS20	1615148

## SICK AT A GLANCE

SICK is one of the leading manufacturers of intelligent sensors and sensor solutions for industrial applications. A unique range of products and services creates the perfect basis for controlling processes securely and efficiently, protecting individuals from accidents and preventing damage to the environment.

We have extensive experience in a wide range of industries and understand their processes and requirements. With intelligent sensors, we can deliver exactly what our customers need. In application centers in Europe, Asia and North America, system solutions are tested and optimized in accordance with customer specifications. All this makes us a reliable supplier and development partner.

Comprehensive services complete our offering: SICK LifeTime Services provide support throughout the machine life cycle and ensure safety and productivity.

For us, that is “Sensor Intelligence.”

## WORLDWIDE PRESENCE:

Contacts and other locations –[www.sick.com](http://www.sick.com)