



OPR20G-RB111517

Glare

GLARE SENSORS

SICK
Sensor Intelligence.



Illustration may differ



Ordering information

Type	Part no.
OPR20G-RB111517	1065685

Other models and accessories → www.sick.com/Glare

Detailed technical data

Features

Sensor principle	Delta-S-Technology®
Dimensions (W x H x D)	42.5 mm x 44 mm x 43.4 mm
Sensing distance	≤ 50 mm
Sensing distance tolerance	± 5 mm
Housing design	Rectangular
Tilt angle tolerance	± 5°
Minimum detectable object (MDO)	12 x 14 mm
Light source	LED, Red ¹⁾
Wave length	640 nm
Light spot size	10 mm x 12 mm
Object speed max.	2 m/s ²⁾
Sensitivity	Fine, middle, coarse
Adjustment	Potentiometer (Sensitivity (Q, Q/, teach-in)) ³⁾ Cable (Teach-in) Single teach-in button (Teach-in)
Teach-in mode	Static 1-point teach-in Static 2-point teach-in Dynamic 2-point teach-in Static 3-point teach-in

¹⁾ Average service life: 100,000 h at T_J = +25 °C.

²⁾ Minimum object size.

³⁾ HIGH = > V_S - 2 V / LOW = open or < 2 V.

Mechanics/electronics

Supply voltage	10 V DC ... 30 V DC ¹⁾
Ripple	$\leq 5 V_{pp}$ ²⁾
Current consumption	$< 150 \text{ mA}$ ³⁾
Switching frequency	500 Hz ⁴⁾
Response time	1 ms ⁵⁾
Jitter	500 μs
Number of switching outputs	2 (Q ₁ , Q ₂)
Switching output	Push-pull: PNP/NPN
Switching output (voltage)	Push-pull: PNP/NPN (High: $V_S - 3 \text{ V}$, Low: $< 3 \text{ V}$)
Output current I_{max}	$< 100 \text{ mA}$ ⁶⁾
Initialization time	$< 2.5 \text{ s}$
Connection type	Male connector M12, 5-pin
Circuit protection	A ⁷⁾ C ⁸⁾ D ⁹⁾
Protection class	III
Enclosure rating	IP67
Weight	130 g
Housing material	Plastic, ABS

¹⁾ Limit values when operated in short-circuit protected network: max. 8 A.

²⁾ May not exceed or fall below U_V tolerances.

³⁾ Without load.

⁴⁾ With light/dark ratio 1:1.

⁵⁾ Signal transit time with resistive load.

⁶⁾ Consumption count Q₁ / Q₂.

⁷⁾ A = V_S connections reverse-polarity protected.

⁸⁾ C = interference suppression.

⁹⁾ D = outputs overcurrent and short-circuit protected.

Ambient data

Ambient operating temperature	-10 °C ... +55 °C
Ambient temperature, storage	-25 °C ... +75 °C
Ambient light immunity	$> 50 \text{ klx}$
Shock load	According to EN 60068-2-27, single shock (30 g/11 MS), continuous shock (25 g/11 MS)
UL File No.	NRKH.E181493

Classifications

eCl@ss 5.0	27270906
eCl@ss 5.1.4	27270906
eCl@ss 6.0	27270906
eCl@ss 6.2	27270906
eCl@ss 7.0	27270906
eCl@ss 8.0	27270906
eCl@ss 8.1	27270906

eCl@ss 9.0	27270906
eCl@ss 10.0	27270906
eCl@ss 11.0	27270906
eCl@ss 12.0	27270906
ETIM 5.0	EC001820
ETIM 6.0	EC001820
ETIM 7.0	EC001820
ETIM 8.0	EC001820
UNSPSC 16.0901	39121528

Dimensional drawing (Dimensions in mm (inch))

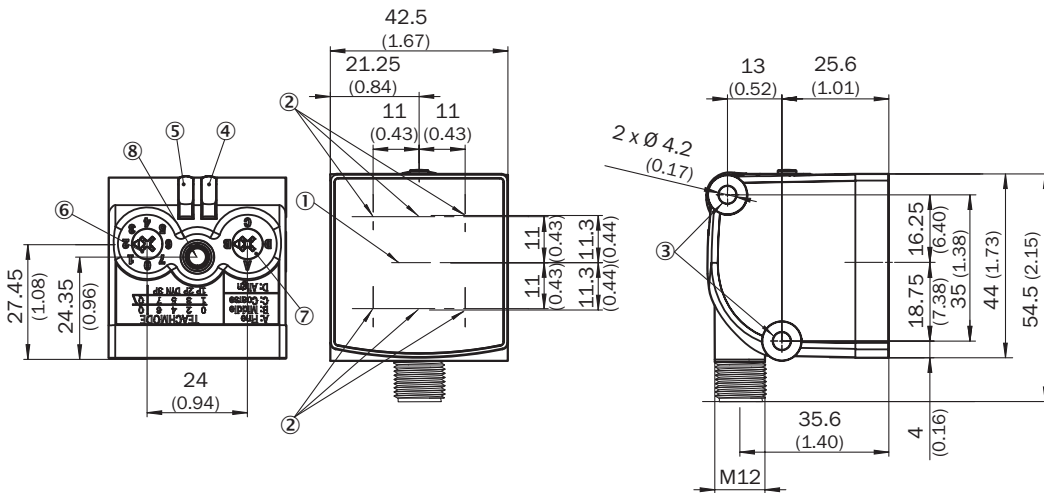

- ① Center of optical axis, sender
- ② Center of optical axis, receiver
- ③ Fixing hole
- ④ LED indicator green: Supply voltage active
- ⑤ Status indicator LED, yellow: Detection of gloss level 1
- ⑥ Teach-in mode, inverting switching output
- ⑦ Sensitivity adjustment (A, B, C) / Operating mode (D)
- ⑧ Teach-in button





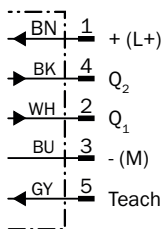



Connection diagram

Cd-280



Recommended accessories

Other models and accessories → www.sick.com/Glare

	Brief description	Type	Part no.
Universal bar clamp systems			
	Universal bar clamp for mounting bars with 12 mm diameter, zinc diecast, without mounting plate and screws	BEF-KHS-KH3	5322626
	Plate N11N for universal clamp bracket, Stainless steel 1.4571 (sheet), Stainless steel 1.4408 (clamp), Universal clamp BEF-KHS-KH3 (5322626), mounting hardware	BEF-KHS-N11N	2071081
	Mounting bar, straight, 200 mm, steel, steel, zinc coated, without mounting hardware	BEF-MS12G-A	4056054
	Mounting bar, straight, 300 mm, steel, steel, zinc coated, without mounting hardware	BEF-MS12G-B	4056055
	Mounting bar, L-shaped, 150 mm x 150 mm, steel, steel, zinc coated, without mounting hardware	BEF-MS12L-A	4056052
	Mounting bar, L-shaped, 250 x 250 mm, steel, steel, zinc coated, without mounting hardware	BEF-MS12L-B	4056053
	Mounting bar, Z-shaped, 150 mm x 70 mm x 150 mm, steel, steel, zinc coated, without mounting hardware	BEF-MS12Z-A	4056056
	Mounting bar, Z-shaped, 150 mm x 70 mm x 250 mm, steel, steel, zinc coated, without mounting hardware	BEF-MS12Z-B	4056057
	Bar clamp for bar diameter of 12 mm (fixing the mounting rod), Aluminum, 2 screws M6 x 30, 2 spring discs	BEF-RMC-D12	5321878
Plug connectors and cables			
	Head A: female connector, M12, 5-pin, straight, A-coded Head B: Flying leads Cable: Sensor/actuator cable, PVC, unshielded, 2 m	YF2A15-020VB5XLEAX	2096239
	Head A: female connector, M12, 5-pin, straight, A-coded Head B: Flying leads Cable: Sensor/actuator cable, PVC, unshielded, 5 m	YF2A15-050VB5XLEAX	2096240
	Head A: female connector, M12, 5-pin, straight, A-coded Head B: Flying leads Cable: Sensor/actuator cable, PVC, unshielded, 10 m	YF2A15-100VB5XLEAX	2096241
	Head A: female connector, M12, 5-pin, angled, A-coded Head B: Flying leads Cable: Sensor/actuator cable, PVC, unshielded, 2 m	YG2A15-020VB5XLEAX	2096215
	Head A: female connector, M12, 5-pin, angled, A-coded Head B: Flying leads Cable: Sensor/actuator cable, PVC, unshielded, 5 m	YG2A15-050VB5XLEAX	2096216
	Head A: female connector, M12, 5-pin, angled, A-coded Head B: Flying leads Cable: Sensor/actuator cable, PVC, unshielded, 10 m	YG2A15-100VB5XLEAX	2096217

SICK AT A GLANCE

SICK is one of the leading manufacturers of intelligent sensors and sensor solutions for industrial applications. A unique range of products and services creates the perfect basis for controlling processes securely and efficiently, protecting individuals from accidents and preventing damage to the environment.

We have extensive experience in a wide range of industries and understand their processes and requirements. With intelligent sensors, we can deliver exactly what our customers need. In application centers in Europe, Asia and North America, system solutions are tested and optimized in accordance with customer specifications. All this makes us a reliable supplier and development partner.

Comprehensive services complete our offering: SICK LifeTime Services provide support throughout the machine life cycle and ensure safety and productivity.

For us, that is “Sensor Intelligence.”

WORLDWIDE PRESENCE:

Contacts and other locations –www.sick.com