



# PBS2-RB600SN1SS0Q5A0Z

PBS plus

PRESSURE SENSORS

**SICK**  
Sensor Intelligence.



Illustration may differ



### Ordering information

Type	Part no.
PBS2-RB600SN1SS0Q5A0Z	6074057

Other models and accessories → [www.sick.com/PBS\\_plus](http://www.sick.com/PBS_plus)

### Detailed technical data

#### Features

<b>Medium</b>	Liquid, gaseous
<b>Pressure type</b>	Gauge pressure
<b>Pressure unit</b>	bar
<b>Measuring range</b>	0 bar ... 600 bar 0 psi ... 8,702 psi
<b>Process temperature</b>	-20 °C ... +85 °C
<b>Maximum ohmic load R<sub>A</sub></b>	4 mA ... 20 mA (R <sub>A</sub> ≤ 0.5 kOhm) 0 V ... 10 V, 3-wire (R <sub>A</sub> > 10 kOhm)
<b>Zero point adjustment</b>	Max. + 3 % of span
<b>Output signal</b>	IO-Link/PNP/NPN + PNP/NPN + 4 mA ... 20 mA / 0 V ... 10 V
<b>Rotatable housing</b>	Display against housing with electrical connection: 330 ° Housing against process connection: 320 °
<b>Display</b>	14-Segment LED, red, 4-digit, character height 9 mm, can be rotated electronically by 180 ° Update: 1,000, 500, 200, 100 ms (adjustable)

#### Mechanics/electronics

<b>Process connection</b>	1/4" NPT
<b>Wetted parts</b>	Pressure connection: stainless steel 316L Pressure sensor: stainless steel 316L (for measurement ranges from 0 bar ... 10 bar rel stainless steel 13-8 PH)
<b>Internal transmission fluid</b>	Silicone oil (only with pressure ranges < 0 bar ... 10 bar and ≤ 0 bar abs ... 25 bar abs)
<b>Pressure port</b>	3.5 mm Standard
<b>Housing material</b>	Lower body: stainless steel 304, Plastic head: PC + ABS, Buttons: TPE-E, Display window: PC

<sup>1)</sup> Enclosure rating IP per IEC 60529. The enclosure rating classes specified only apply when connected with female connectors that provide the corresponding enclosure rating.

<b>Connection type</b>	Round connector M12 x 1, 5-pin
<b>Supply voltage</b>	15 V DC ... 35 V DC
<b>Power consumption</b>	45 mA (for configurations without analog output signal) 70 mA (for configurations with analog output signal)
<b>Total current consumption</b>	Max. 600 mA (including switching current)
<b>Electrical safety</b>	Protection class: III Overvoltage protection: 40 V DC Short-circuit protection: Q <sub>A</sub> , Q <sub>1</sub> , Q <sub>2</sub> towards M Reverse polarity protection: L <sup>+</sup> to M
<b>Isolation voltage</b>	500 V DC
<b>CE-conformity</b>	EMC Directive: 2014/30 / EU (EN 61326-1:2013; EN 61326-2-3:2013), Pressure equipment directive: 2014/68 / EU, Hazardous materials (RoHS): 2011/65 / EU (EN 50581:2012)
<b>Weight sensor</b>	Approx. 220 g
<b>Seal</b>	Without seal
<b>Enclosure rating</b>	IP67 <sup>1)</sup> IP67 <sup>1)</sup>
<b>Protection class III</b>	✓
<b>MTTF</b>	104 years

<sup>1)</sup> Enclosure rating IP per IEC 60529. The enclosure rating classes specified only apply when connected with female connectors that provide the corresponding enclosure rating.

## Performance

<b>Non-linearity</b>	≤ ± 0.25 %, of span (Best Fit Straight Line, BFUL) according to IEC 61298-2
<b>Accuracy</b>	≤ ± 0.5 % of the span
<b>Setting accuracy of switching outputs</b>	≤ ± 0.5 % of span
<b>Response time</b>	≤ 5 ms
<b>Long-term drift/one-year stability</b>	≤ ± 0.1 % of the span according to IEC 61298-2 ≤ 0.2 % of the span According to IEC 61298-2 for measuring range ≤ 0.6 bar or flush-mounted membrane (0 psi ... 10 psi)
<b>Temperature coefficient in rated temperature range</b>	Average TC of the zero point: ≤ ± 0.16% of the span / 10 K Average TC of the span ≤ ± 0.16% of the span / 10 K
<b>Rated temperature range</b>	0 °C ... +80 °C
<b>Service life</b>	Minimum 100 Mio. load cycles

## Ambient data

<b>Ambient temperature</b>	-20 °C ... +80 °C
<b>Storage temperature</b>	-20 °C ... +70 °C
<b>Relative humidity</b>	≤ 75 %
<b>Shock load</b>	50 g, 6 ms according to IEC 60068-2-27 (mechanical shock)
<b>Vibration load</b>	20 g, 10 Hz ... 2,000 Hz (IEC 60068-2-6, at resonance)

## Classifications

<b>ECLASS 5.0</b>	27200620
<b>ECLASS 5.1.4</b>	27200620
<b>ECLASS 6.0</b>	27200620
<b>ECLASS 6.2</b>	27200620
<b>ECLASS 7.0</b>	27200620

<b>ECLASS 8.0</b>	27200620
<b>ECLASS 8.1</b>	27200620
<b>ECLASS 9.0</b>	27200620
<b>ECLASS 10.0</b>	27200620
<b>ECLASS 11.0</b>	27200620
<b>ECLASS 12.0</b>	27200620
<b>ETIM 5.0</b>	EC000243
<b>ETIM 6.0</b>	EC000243
<b>ETIM 7.0</b>	EC000243
<b>ETIM 8.0</b>	EC000243
<b>UNSPSC 16.0901</b>	41112409

### Dimensional drawing (Dimensions in mm (inch))

1/4" NPT

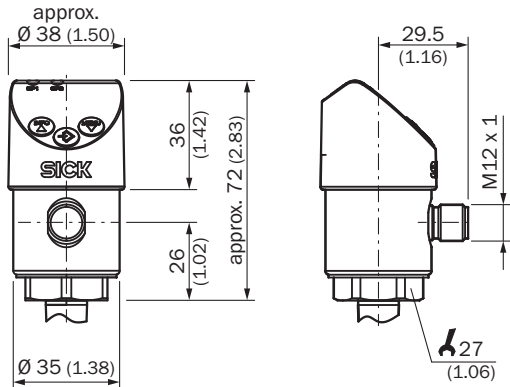
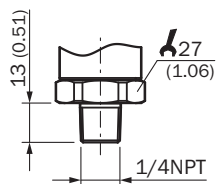

### Connection type

M12 x 1, 4-pin 2 switching outputs/  
1 switching output + 1 analog output



L<sup>1</sup> = 1, M = 3, Q<sub>1</sub> = 4, Q<sub>2</sub> = 2  
C/Q<sub>1</sub> = 4, Q<sub>1</sub> = 2

M12 x 1, 5-pin 2 switching outputs + 1 analog output



L<sup>1</sup> = 1, M = 3, Q<sub>1</sub> = 4, Q<sub>2</sub> = 2, Q<sub>3</sub> = 5  
C/Q<sub>1</sub> = 4

## SICK AT A GLANCE

SICK is one of the leading manufacturers of intelligent sensors and sensor solutions for industrial applications. A unique range of products and services creates the perfect basis for controlling processes securely and efficiently, protecting individuals from accidents and preventing damage to the environment.

We have extensive experience in a wide range of industries and understand their processes and requirements. With intelligent sensors, we can deliver exactly what our customers need. In application centers in Europe, Asia and North America, system solutions are tested and optimized in accordance with customer specifications. All this makes us a reliable supplier and development partner.

Comprehensive services complete our offering: SICK LifeTime Services provide support throughout the machine life cycle and ensure safety and productivity.

For us, that is “Sensor Intelligence.”

## WORLDWIDE PRESENCE:

Contacts and other locations –[www.sick.com](http://www.sick.com)