



# PSSH-CB6X0ST1S0BMA0Z

PBS Hygienic

PRESSURE SENSORS

**SICK**  
Sensor Intelligence.



Illustration may differ



### Ordering information

Type	Part no.
PBSH-CB6X0ST1S0BMA0Z	6066199

Other models and accessories → [www.sick.com/PBS\\_Hygienic](http://www.sick.com/PBS_Hygienic)

### Detailed technical data

#### Features

<b>Medium</b>	Liquid, gaseous
<b>Pressure type</b>	Compound pressure
<b>Pressure unit</b>	bar
<b>Measuring range</b>	-1 bar ... 5 bar
<b>Overpressure safety</b>	2-fold
<b>Process temperature</b>	-20 °C ... +100 °C, +135 °C for max. 1 h
<b>Maximum ohmic load <math>R_A</math></b>	≤ 0.5 kΩ, 4 mA ... 20 mA ( $R_A$ ≤ 0.5 kΩhm) 0 V ... 10 V ( $R_A$ > 10 kΩhm)
<b>Zero point adjustment</b>	Max. + 3 % of span
<b>Output signal</b>	1 x PNP + 4 mA ... 20 mA
<b>Rotatable housing</b>	Display against housing with electrical connection: 330 ° Housing against process connection: 320 °
<b>Display</b>	14-segment-LED, blue, 4-digits, height 9 mm, electronically turnable by 180 ° Accuracy: ≤ 1 % of span ± 1 digit Update: 1,000, 500, 200, 100 ms (adjustable)

#### Mechanics/electronics

<b>Process connection</b>	Tri-Clamp 1 ½"
<b>Wetted parts</b>	Stainless steel 1.4435 / 316L
<b>Internal transmission fluid</b>	Medical white oil, FDA compliant according to CFR 172.878 and 21 CFR 178.3620(a), compliant to USP, EP, and JP
<b>Housing material</b>	Lower body: stainless steel 304, Plastic head: PC + ABS, Buttons: TPE-E, Display window: PC
<b>Connection type</b>	M12 round connector x 1, 4-pin
<b>Supply voltage</b>	15 V DC ... 35 V DC
<b>Power consumption</b>	Max. 70 mA
<b>Total current consumption</b>	Max. 320 mA (incl. switching current)
<b>Electrical safety</b>	Protection class: III Overvoltage protection: 40 V DC Short-circuit protection: $Q_A$ , $Q_1$ , $Q_2$ towards M

<sup>1)</sup> Enclosure rating IP per IEC 60529. The enclosure rating classes specified only apply when connected with female connectors that provide the corresponding enclosure rating.

	Reverse polarity protection: L <sup>+</sup> to M
<b>Isolation voltage</b>	500 V DC
<b>CE-conformity</b>	EMC directive: 2004/108/EC, EN 61326-2-3
<b>Seal</b>	Without seal
<b>Enclosure rating</b>	IP65 <sup>1)</sup> IP67 <sup>1)</sup>
<b>Protection class III</b>	✓

<sup>1)</sup> Enclosure rating IP per IEC 60529. The enclosure rating classes specified only apply when connected with female connectors that provide the corresponding enclosure rating.

### Performance

<b>Non-linearity</b>	≤ ± 0.5 %, of span (Best Fit Straight Line, BFSL) according to IEC 61298-2
<b>Accuracy</b>	≤ ± 1 % of the span
<b>Setting accuracy of switching outputs</b>	≤ ± 0.5 % of span
<b>Response time</b>	3 ms
<b>Long-term drift/one-year stability</b>	≤ ± 0.2 % of the span according to IEC 61298-2
<b>Temperature coefficient in rated temperature range</b>	Typical TC of the zero point: in temperature range 0 °C ... 20 °C: 0.7% of the range / 10 K; in temperature range 20 °C ... 80 °C: 0.2% of span / 10 K. Typical TC of span: in temperature range 0 °C ... 80 °C: 0.1% of span / 10 K <sup>1)</sup>
<b>Rated temperature range</b>	0 °C ... +80 °C

<sup>1)</sup> With Tri-Clamp 1 ½", Tri-Clamp 2", Conical coupling (DIN 11851) DN 40 with union nut, Conical coupling (DIN 11851) DN 50 with union nut, Clamp (DIN 32676) DN 40, Clamp (DIN 32676) DN 50, G 1 hygienic.

### Ambient data

<b>Ambient temperature</b>	-20 °C ... +80 °C
<b>Storage temperature</b>	-20 °C ... +80 °C
<b>Relative humidity</b>	45 % ... 75 %
<b>Shock load</b>	50 g according to IEC 60068-2-27 (mechanical shock)
<b>Vibration load</b>	10 g according to IEC 60068-2-6 (vibration under resonance)

### Classifications

<b>ECLASS 5.0</b>	27200620
<b>ECLASS 5.1.4</b>	27200620
<b>ECLASS 6.0</b>	27200620
<b>ECLASS 6.2</b>	27200620
<b>ECLASS 7.0</b>	27200620
<b>ECLASS 8.0</b>	27200620
<b>ECLASS 8.1</b>	27200620
<b>ECLASS 9.0</b>	27200620
<b>ECLASS 10.0</b>	27200620
<b>ECLASS 11.0</b>	27200620
<b>ECLASS 12.0</b>	27200620
<b>ETIM 5.0</b>	EC000243
<b>ETIM 6.0</b>	EC000243
<b>ETIM 7.0</b>	EC000243

<b>ETIM 8.0</b>	EC000243
<b>UNSPSC 16.0901</b>	41112409

**Dimensional drawing** (Dimensions in mm (inch))

Clamp

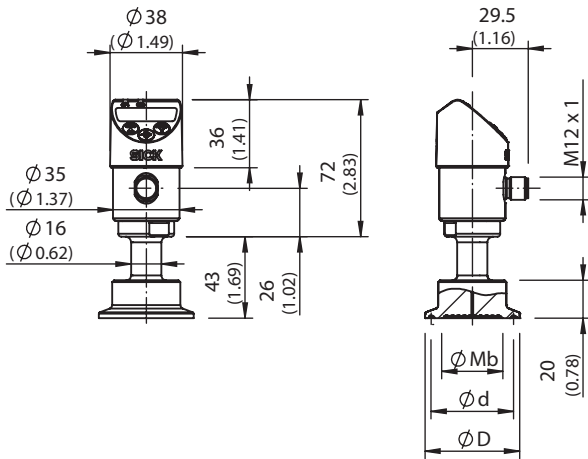

Tri-Clamp	$\varnothing Mb$	$\varnothing d$	$\varnothing D$
1 1/2"	32.0 (1.25)	43.5 (1.71)	50.5 (1.98)
2"	40.0 (1.57)	56.6 (2.22)	64.0 (2.51)

**Connection type**

M12 round connector x 1, 4-pin

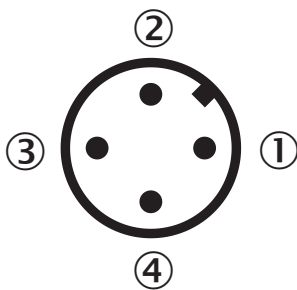

- ① L<sup>+</sup>: Positive supply connection
- ② Q<sub>A</sub>: Analog output
- ③ M: Negative supply connection
- ④ C/Q<sub>1</sub>: Switching output 1 (with IO-Link: communication / switching output 1)

## SICK AT A GLANCE

SICK is one of the leading manufacturers of intelligent sensors and sensor solutions for industrial applications. A unique range of products and services creates the perfect basis for controlling processes securely and efficiently, protecting individuals from accidents and preventing damage to the environment.

We have extensive experience in a wide range of industries and understand their processes and requirements. With intelligent sensors, we can deliver exactly what our customers need. In application centers in Europe, Asia and North America, system solutions are tested and optimized in accordance with customer specifications. All this makes us a reliable supplier and development partner.

Comprehensive services complete our offering: SICK LifeTime Services provide support throughout the machine life cycle and ensure safety and productivity.

For us, that is “Sensor Intelligence.”

## WORLDWIDE PRESENCE:

Contacts and other locations –[www.sick.com](http://www.sick.com)