



PSSH-RB025SD4S0BMA0Z

PBS Hygienic

PRESSURE SENSORS

SICK
Sensor Intelligence.



Illustration may differ



Ordering information

Type	Part no.
PBSH-RB025SD4S0BMA0Z	6054657

Other models and accessories → www.sick.com/PBS_Hygienic

Detailed technical data

Features

Medium	Liquid, gaseous
Pressure type	Gauge pressure
Pressure unit	bar
Measuring range	0 bar ... 25 bar
Overpressure safety	2-fold
Process temperature	-20 °C ... +100 °C, +135 °C for max. 1 h
Maximum ohmic load R_A	≤ 0.5 kΩ, 4 mA ... 20 mA (R_A ≤ 0.5 kΩhm) 0 V ... 10 V (R_A > 10 kΩhm)
Zero point adjustment	Max. + 3 % of span
Output signal	1 x PNP + 4 mA ... 20 mA
Rotatable housing	Display against housing with electrical connection: 330 ° Housing against process connection: 320 °
Display	14-segment-LED, blue, 4-digits, height 9 mm, electronically turnable by 180 ° Accuracy: ≤ 1 % of span ± 1 digit Update: 1,000, 500, 200, 100 ms (adjustable)

Mechanics/electronics

Process connection	Clamp (DIN 32676) DN 40
Wetted parts	Stainless steel 1.4435 / 316L
Internal transmission fluid	Medical white oil, FDA compliant according to CFR 172.878 and 21 CFR 178.3620(a), compliant to USP, EP, and JP
Housing material	Lower body: stainless steel 304, Plastic head: PC + ABS, Buttons: TPE-E, Display window: PC
Connection type	M12 round connector x 1, 4-pin
Supply voltage	15 V DC ... 35 V DC
Power consumption	Max. 70 mA
Total current consumption	Max. 320 mA (incl. switching current)
Electrical safety	Protection class: III Overvoltage protection: 40 V DC Short-circuit protection: Q_A , Q_1 , Q_2 towards M

¹⁾ Enclosure rating IP per IEC 60529. The enclosure rating classes specified only apply when connected with female connectors that provide the corresponding enclosure rating.

	Reverse polarity protection: L ⁺ to M
Isolation voltage	500 V DC
CE-conformity	EMC directive: 2004/108/EC, EN 61326-2-3
Seal	Without seal
Enclosure rating	IP65 ¹⁾ IP67 ¹⁾
Protection class III	✓

¹⁾ Enclosure rating IP per IEC 60529. The enclosure rating classes specified only apply when connected with female connectors that provide the corresponding enclosure rating.

Performance

Non-linearity	≤ ± 0.5 %, of span (Best Fit Straight Line, BFSL) according to IEC 61298-2
Accuracy	≤ ± 1 % of the span
Setting accuracy of switching outputs	≤ ± 0.5 % of span
Response time	3 ms
Long-term drift/one-year stability	≤ ± 0.2 % of the span according to IEC 61298-2
Temperature coefficient in rated temperature range	Typical TC of the zero point: in temperature range 0 °C ... 20 °C: 0.7% of the range / 10 K; in temperature range 20 °C ... 80 °C: 0.2% of span / 10 K. Typical TC of span: in temperature range 0 °C ... 80 °C: 0.1% of span / 10 K ¹⁾
Rated temperature range	0 °C ... +80 °C

¹⁾ With Tri-Clamp 1 ½", Tri-Clamp 2", Conical coupling (DIN 11851) DN 40 with union nut, Conical coupling (DIN 11851) DN 50 with union nut, Clamp (DIN 32676) DN 40, Clamp (DIN 32676) DN 50, G 1 hygienic.

Ambient data

Ambient temperature	-20 °C ... +80 °C
Storage temperature	-20 °C ... +80 °C
Relative humidity	45 % ... 75 %
Shock load	50 g according to IEC 60068-2-27 (mechanical shock)
Vibration load	10 g according to IEC 60068-2-6 (vibration under resonance)

Classifications

ECLASS 5.0	27200620
ECLASS 5.1.4	27200620
ECLASS 6.0	27200620
ECLASS 6.2	27200620
ECLASS 7.0	27200620
ECLASS 8.0	27200620
ECLASS 8.1	27200620
ECLASS 9.0	27200620
ECLASS 10.0	27200620
ECLASS 11.0	27200620
ECLASS 12.0	27200620
ETIM 5.0	EC000243
ETIM 6.0	EC000243
ETIM 7.0	EC000243

ETIM 8.0	EC000243
UNSPSC 16.0901	41112409

Dimensional drawing (Dimensions in mm (inch))

Clamp

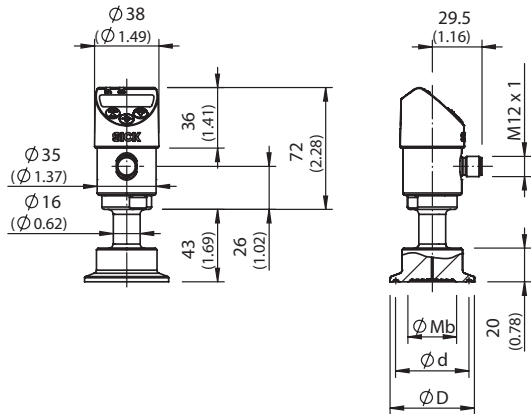

DIN 32676	$\varnothing Mb$	$\varnothing d$	$\varnothing D$
DN 32	29.0 (1.14)	43.5 (1.71)	50.5 (1.98)
DIN 40	32.0 (1.25)	43.5 (1.71)	50.5 (1.98)
DIN 50	40.0 (1.57)	56.6 (2.22)	64.0 (2.51)

Connection type

M12 round connector x 1, 4-pin

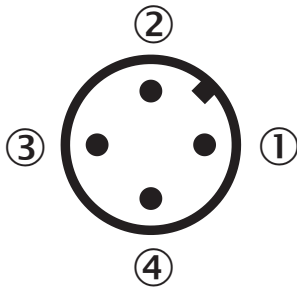

- ① L⁺: Positive supply connection
- ② Q_A: Analog output
- ③ M: Negative supply connection
- ④ C/Q₁: Switching output 1 (with IO-Link: communication / switching output 1)

SICK AT A GLANCE

SICK is one of the leading manufacturers of intelligent sensors and sensor solutions for industrial applications. A unique range of products and services creates the perfect basis for controlling processes securely and efficiently, protecting individuals from accidents and preventing damage to the environment.

We have extensive experience in a wide range of industries and understand their processes and requirements. With intelligent sensors, we can deliver exactly what our customers need. In application centers in Europe, Asia and North America, system solutions are tested and optimized in accordance with customer specifications. All this makes us a reliable supplier and development partner.

Comprehensive services complete our offering: SICK LifeTime Services provide support throughout the machine life cycle and ensure safety and productivity.

For us, that is “Sensor Intelligence.”

WORLDWIDE PRESENCE:

Contacts and other locations –www.sick.com