



PFT-FRBX16SF10SSAMSSZ

PFT

PRESSURE SENSORS

SICK
Sensor Intelligence.



Illustration may differ



Ordering information

Type	Part no.
PFT-FRBX16SF10SSAMSSZ	6042220

Other models and accessories → www.sick.com/PFT

Detailed technical data

Features

Medium	Liquid, gaseous
Pressure type	Gauge pressure
Pressure unit	bar
Measuring range	0 bar ... 0.16 bar
Process temperature	-30 °C ... +100 °C
Maximum ohmic load R_A	4 mA ... 20 mA, 2-wire ($R_A \leq (L^+ - 10 \text{ V}) / 0.02 \text{ A [Ohm]}$) 0 V ... 5 V, 3-wire ($R_A > 5 \text{ kOhm}$) 0 V ... 10 V, 3-wire ($R_A > 10 \text{ kOhm}$)
Output signal	4 mA ... 20 mA, 2-wire
Specialty	Without

Mechanics/electronics

Process connection	G 1 B flush-mounted with O-ring
Wetted parts	Flush-mounted membrane: Stainless steel 1.4571 with NBR O-ring or FKM O-ring (FKM with integrated cooling element)
Internal transmission fluid	Synthetic oil (Not available for version with standard membrane for pressure ranges > 25 bar)
Pressure port	Front-flush membrane
Housing material	Stainless steel 1.4571
Connection type	M12 round connector x 1, 4-pin
Supply voltage	10 V DC ... 30 V DC
Electrical safety	Overvoltage protection: 36 V DC Short-circuit protection: Q_A towards M Reverse polarity protection: L^+ to M Protection class: III
Dielectric strength	500 V DC, NEC Class O2 power supply (low voltage and low current max. 100 VA even in the event of a fault)
CE-conformity	Pressure equipment directive: 2014/68/EU EMC directive: 2004/108/EC, EN 61326-2-3
Weight sensor	Approx. 200 g

¹⁾ Enclosure rating IP per IEC 60529. The enclosure rating classes specified only apply when connected with female connectors that provide the corresponding enclosure rating.

Seal	NBR
Enclosure rating	IP67 ¹⁾
Protection class III	✓
MTTF	403 years

¹⁾ Enclosure rating IP per IEC 60529. The enclosure rating classes specified only apply when connected with female connectors that provide the corresponding enclosure rating.

Performance

Non-linearity	$\leq \pm 0.2 \%$, of span (Best Fit Straight Line, BFSL) according to IEC 61298-2
Accuracy	$\leq \pm 0.5 \%$ of the span
Non-repeatability	$\leq \pm 0.1 \%$ of the span
Response time (10 % ... 90 %)	$\leq 1 \text{ ms} \leq 10 \text{ ms}$ at medium temperatures below $< -30 \text{ °C}$ for pressure ranges up to 25 bar or with flush-mounted membrane
Long-term drift/one-year stability	$\leq \pm 0.2 \%$ of span (at reference conditions)
Temperature coefficient in rated temperature range	Mean TC of zero: $\leq 0.2 \%$ of span / 10 K ($< 0.4 \%$ for pressure ranges $\leq 0.25 \text{ bar}$) Mean TC of span $\leq 0.2 \%$ of span / 10 K
Rated temperature range	0 °C ... +80 °C
Service life	Minimum 10 Mio. load cycles

Ambient data

Ambient temperature	-20 °C ... +80 °C
Storage temperature	-40 °C ... +100 °C, with flush-mounted membrane and cooling element -20 °C ... +100 °C
Shock load	1000 g according to IEC 60068-2-27 (mechanical shock) 400 g according to IEC 60068-2-27 (mechanical shock) for version with integrated cooling element
Vibration load	20 g according to IEC 60068-2-6 (vibration under resonance) 10 g according to IEC 60068-2-6 (vibration undencr resonae) for version with integrated cooling element

Classifications

ECLASS 5.0	27200614
ECLASS 5.1.4	27200614
ECLASS 6.0	27200614
ECLASS 6.2	27200614
ECLASS 7.0	27200614
ECLASS 8.0	27200614
ECLASS 8.1	27200614
ECLASS 9.0	27200614
ECLASS 10.0	27200614
ECLASS 11.0	27200614
ECLASS 12.0	27200614
ETIM 5.0	EC011478
ETIM 6.0	EC011478
ETIM 7.0	EC011478
ETIM 8.0	EC011478
UNSPSC 16.0901	41112410

Dimensional drawing (Dimensions in mm (inch))

G 1 B without cooling section

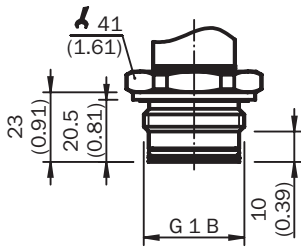

G 1 B with cooling section

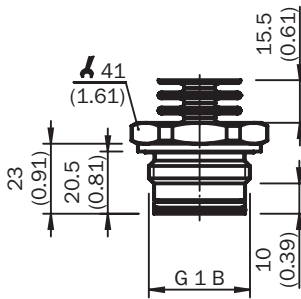

Housing with circular plug-in connector M12 x 1

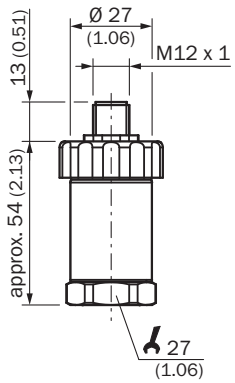



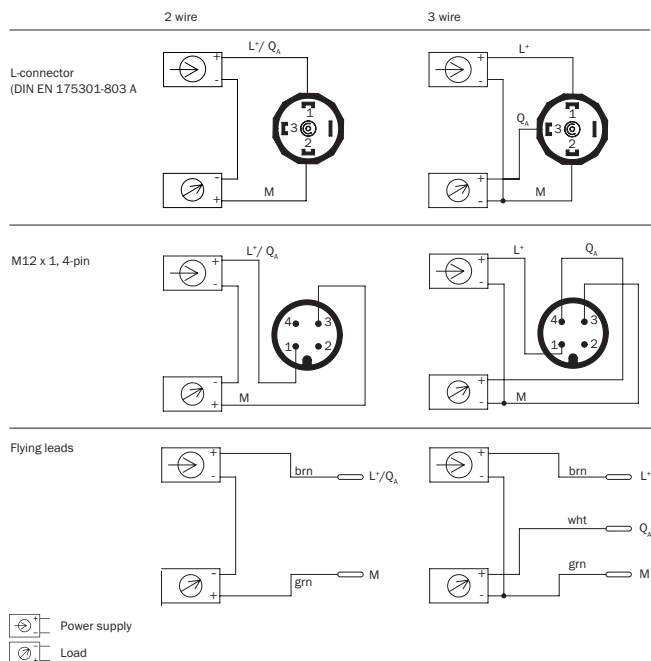





Connection type











Recommended accessories

Other models and accessories → www.sick.com/PFT

	Brief description	Type	Part no.
Flanges			
	Weld-in flange/weld-in socket for articles with flush-mounted membrane, process connection G 1 B, Stainless steel 1.4571	BEF-FL-316G10-B0PH	5322450
Mounting brackets and plates			
	Mounting bracket for simple and stable wall mounting of pressure sensors with 27 mm hexagon, Aluminum	BEF-FL-ALUPBS-HLDR	5322501
Others			
	<ul style="list-style-type: none"> Connection type head A: Female connector, M12, 4-pin, straight, A-coded Connection type head B: Flying leads Signal type: Sensor/actuator cable Cable: 15 m, 4-wire, PUR, halogen-free Description: Sensor/actuator cable, unshielded Application: Zones with oils and lubricants, Drag chain operation, Robot 	YF2A14-150UB3XLEAX	2095610
	<ul style="list-style-type: none"> Connection type head A: Female connector, M12, 4-pin, straight, A-coded Connection type head B: Flying leads Signal type: Sensor/actuator cable Cable: 20 m, 4-wire, PUR, halogen-free Description: Sensor/actuator cable, unshielded Application: Zones with oils and lubricants, Drag chain operation, Robot 	YF2A14-200UB3XLEAX	2095611

	Brief description	Type	Part no.
	<ul style="list-style-type: none"> • Connection type head A: Female connector, M12, 4-pin, straight, A-coded • Connection type head B: Flying leads • Signal type: Sensor/actuator cable • Cable: 25 m, 4-wire, PUR, halogen-free • Description: Sensor/actuator cable, unshielded • Application: Zones with oils and lubricants, Drag chain operation, Robot 	YF2A14-250UB3XLEAX	2095615
	<ul style="list-style-type: none"> • Connection type head A: Female connector, M12, 4-pin, angled, A-coded • Connection type head B: Flying leads • Signal type: Sensor/actuator cable • Cable: 15 m, 4-wire, PUR, halogen-free • Description: Sensor/actuator cable, unshielded • Application: Zones with oils and lubricants, Drag chain operation, Robot 	YG2A14-150UB3XLEAX	2095769
	<ul style="list-style-type: none"> • Connection type head A: Female connector, M12, 4-pin, angled, A-coded • Connection type head B: Flying leads • Signal type: Sensor/actuator cable • Cable: 20 m, 4-wire, PUR, halogen-free • Description: Sensor/actuator cable, unshielded • Application: Zones with oils and lubricants, Drag chain operation, Robot 	YG2A14-200UB3XLEAX	2095770
	<ul style="list-style-type: none"> • Connection type head A: Female connector, M12, 4-pin, angled, A-coded • Connection type head B: Flying leads • Signal type: Sensor/actuator cable • Cable: 25 m, 4-wire, PUR, halogen-free • Description: Sensor/actuator cable, unshielded • Application: Zones with oils and lubricants, Drag chain operation, Robot 	YG2A14-250UB3XLEAX	2095771
	<ul style="list-style-type: none"> • Connection type head A: Female connector, M12, 4-pin, straight, A-coded • Connection type head B: Flying leads • Signal type: Sensor/actuator cable • Cable: 5 m, 4-wire, PVC • Description: Sensor/actuator cable, unshielded • Application: Zones with chemicals 	YF2A14-050VB3XLEAX	2096235
	<ul style="list-style-type: none"> • Connection type head A: Female connector, M12, 4-pin, angled, A-coded • Connection type head B: Flying leads • Signal type: Sensor/actuator cable • Cable: 2 m, 4-wire, PVC • Description: Sensor/actuator cable, unshielded • Application: Zones with chemicals 	YG2A14-020VB3XLEAX	2095895
	<ul style="list-style-type: none"> • Connection type head A: Female connector, M12, 4-pin, straight, A-coded • Connection type head B: Flying leads • Signal type: Sensor/actuator cable • Cable: 10 m, 4-wire, PVC • Description: Sensor/actuator cable, unshielded • Application: Zones with chemicals 	YF2A14-100VB3XLEAX	2096236
	<ul style="list-style-type: none"> • Connection type head A: Female connector, M12, 4-pin, straight, A-coded • Connection type head B: Flying leads • Signal type: Sensor/actuator cable • Cable: 15 m, 4-wire, PVC • Description: Sensor/actuator cable, unshielded • Application: Zones with chemicals 	YF2A14-150VB3XLEAX	2096237
	<ul style="list-style-type: none"> • Connection type head A: Female connector, M12, 4-pin, straight, A-coded • Connection type head B: Flying leads • Signal type: Sensor/actuator cable • Cable: 20 m, 4-wire, PVC • Description: Sensor/actuator cable, unshielded • Application: Zones with chemicals 	YF2A14-200VB3XLEAX	2096238
	<ul style="list-style-type: none"> • Connection type head A: Female connector, M12, 4-pin, straight, A-coded • Connection type head B: Flying leads • Signal type: Sensor/actuator cable • Cable: 5 m, 4-wire, PUR, halogen-free • Description: Sensor/actuator cable, unshielded • Application: Zones with oils and lubricants, Drag chain operation, Robot 	YF2A14-050UB3XLEAX	2095608

	Brief description	Type	Part no.
	<ul style="list-style-type: none"> Connection type head A: Female connector, M12, 4-pin, straight, A-coded Connection type head B: Flying leads Signal type: Sensor/actuator cable Cable: 10 m, 4-wire, PUR, halogen-free Description: Sensor/actuator cable, unshielded Application: Zones with oils and lubricants, Drag chain operation, Robot 	YF2A14-100UB3XLEAX	2095609
	<ul style="list-style-type: none"> Connection type head A: Female connector, M12, 4-pin, angled, A-coded Connection type head B: Flying leads Signal type: Sensor/actuator cable Cable: 2 m, 4-wire, PUR, halogen-free Description: Sensor/actuator cable, unshielded Application: Zones with oils and lubricants, Drag chain operation, Robot 	YG2A14-020UB3XLEAX	2095766
	<ul style="list-style-type: none"> Connection type head A: Female connector, M12, 4-pin, angled, A-coded Connection type head B: Flying leads Signal type: Sensor/actuator cable Cable: 5 m, 4-wire, PUR, halogen-free Description: Sensor/actuator cable, unshielded Application: Zones with oils and lubricants, Drag chain operation, Robot 	YG2A14-050UB3XLEAX	2095767
	<ul style="list-style-type: none"> Connection type head A: Female connector, M12, 4-pin, angled, A-coded Connection type head B: Flying leads Signal type: Sensor/actuator cable Cable: 10 m, 4-wire, PUR, halogen-free Description: Sensor/actuator cable, unshielded Application: Zones with oils and lubricants, Drag chain operation, Robot 	YG2A14-100UB3XLEAX	2095768
	<ul style="list-style-type: none"> Connection type head A: Female connector, M12, 4-pin, straight, A-coded Connection type head B: Flying leads Signal type: Sensor/actuator cable Cable: 2 m, 4-wire, PUR, halogen-free Description: Sensor/actuator cable, unshielded Application: Zones with oils and lubricants, Drag chain operation, Robot 	YF2A14-020UB3XLEAX	2095607
	<ul style="list-style-type: none"> Connection type head A: Female connector, M12, 4-pin, straight, A-coded Connection type head B: Flying leads Signal type: Sensor/actuator cable Cable: 2 m, 4-wire, PVC Description: Sensor/actuator cable, unshielded Application: Zones with chemicals 	YF2A14-020VB3XLEAX	2096234
	<ul style="list-style-type: none"> Connection type head A: Female connector, M12, 4-pin, angled, A-coded Connection type head B: Flying leads Signal type: Sensor/actuator cable Cable: 10 m, 4-wire, PVC Description: Sensor/actuator cable, unshielded Application: Zones with chemicals 	YG2A14-100VB3XLEAX	2095898
	<ul style="list-style-type: none"> Connection type head A: Female connector, M12, 4-pin, angled, A-coded Connection type head B: Flying leads Signal type: Sensor/actuator cable Cable: 15 m, 4-wire, PVC Description: Sensor/actuator cable, unshielded Application: Zones with chemicals 	YG2A14-150VB3XLEAX	2096213
	<ul style="list-style-type: none"> Connection type head A: Female connector, M12, 4-pin, angled, A-coded Connection type head B: Flying leads Signal type: Sensor/actuator cable Cable: 20 m, 4-wire, PVC Description: Sensor/actuator cable, unshielded Application: Zones with chemicals 	YG2A14-200VB3XLEAX	2096214
	<ul style="list-style-type: none"> Connection type head A: Female connector, M12, 4-pin, angled, A-coded Connection type head B: Flying leads Signal type: Sensor/actuator cable Cable: 5 m, 4-wire, PVC Description: Sensor/actuator cable, unshielded Application: Zones with chemicals 	YG2A14-050VB3XLEAX	2095897

SICK AT A GLANCE

SICK is one of the leading manufacturers of intelligent sensors and sensor solutions for industrial applications. A unique range of products and services creates the perfect basis for controlling processes securely and efficiently, protecting individuals from accidents and preventing damage to the environment.

We have extensive experience in a wide range of industries and understand their processes and requirements. With intelligent sensors, we can deliver exactly what our customers need. In application centers in Europe, Asia and North America, system solutions are tested and optimized in accordance with customer specifications. All this makes us a reliable supplier and development partner.

Comprehensive services complete our offering: SICK LifeTime Services provide support throughout the machine life cycle and ensure safety and productivity.

For us, that is “Sensor Intelligence.”

WORLDWIDE PRESENCE:

Contacts and other locations –www.sick.com