



# PFT-FRBX25SF10HCAMSSL

PFT

PRESSURE SENSORS

**SICK**  
Sensor Intelligence.



Illustration may differ



### Ordering information

| Type                  | Part no. |
|-----------------------|----------|
| PFT-FRBX25SF10HCAMSSL | 6044567  |

Other models and accessories → [www.sick.com/PFT](http://www.sick.com/PFT)

### Detailed technical data

#### Features

|  |   |
|--|---|
| <b>Medium</b>                              | Liquid, gaseous   |
| <b>Pressure type</b>                       | Gauge pressure  |
| <b>Pressure unit</b>                       | bar   |
| <b>Measuring range</b>                     | 0 bar ... 0.25 bar  |
| <b>Process temperature</b>                 | -20 °C ... +150 °C  |
| <b>Maximum ohmic load <math>R_A</math></b> | 4 mA ... 20 mA, 2-wire ( $R_A \leq (L^+ - 10 \text{ V}) / 0.02 \text{ A [Ohm]}$ )<br>0 V ... 5 V, 3-wire ( $R_A > 5 \text{ kOhm}$ )<br>0 V ... 10 V, 3-wire ( $R_A > 10 \text{ kOhm}$ ) |
| <b>Output signal</b>                       | 4 mA ... 20 mA, 2-wire  |
| <b>Specialty</b>                           | F&B suitable filler liquid  |

#### Mechanics/electronics

|                                    |  |
|------------------------------------|--|
| <b>Process connection</b>          | G 1 B flush-mounted with O-ring  |
| <b>Wetted parts</b>                | Flush-mounted membrane: Stainless steel 1.4571 with NBR O-ring or FKM O-ring (FKM with integrated cooling element)                               |
| <b>Internal transmission fluid</b> | Synthetic oil (Not available for version with standard membrane for pressure ranges > 25 bar)  |
| <b>Pressure port</b>               | Front-flush membrane   |
| <b>Housing material</b>            | Stainless steel 1.4571   |
| <b>Connection type</b>             | M12 round connector x 1, 4-pin   |
| <b>Supply voltage</b>              | 10 V DC ... 30 V DC  |
| <b>Electrical safety</b>           | Overvoltage protection: 36 V DC<br>Short-circuit protection: $Q_A$ towards M<br>Reverse polarity protection: $L^+$ to M<br>Protection class: III |
| <b>Dielectric strength</b>         | 500 V DC, NEC Class O2 power supply (low voltage and low current max. 100 VA even in the event of a fault)                                       |
| <b>CE-conformity</b>               | Pressure equipment directive: 2014/68/EU<br>EMC directive: 2004/108/EC, EN 61326-2-3   |
| <b>Weight sensor</b>               | Approx. 200 g  |

<sup>1)</sup> Enclosure rating IP per IEC 60529. The enclosure rating classes specified only apply when connected with female connectors that provide the corresponding enclosure rating.

|                             |                    |
|-----------------------------|--------------------|
| <b>Seal</b>                 | FPM/FKM            |
| <b>Enclosure rating</b>     | IP67 <sup>1)</sup> |
| <b>Protection class III</b> | ✓                  |
| <b>MTTF</b>                 | 403 years          |

<sup>1)</sup> Enclosure rating IP per IEC 60529. The enclosure rating classes specified only apply when connected with female connectors that provide the corresponding enclosure rating.

## Performance

|   |  |
|---|--|
| <b>Non-linearity</b>                                      | ≤ ± 0.2 %, of span (Best Fit Straight Line, BFSL) according to IEC 61298-2   |
| <b>Accuracy</b>   | ≤ ± 0.5 % of the span  |
| <b>Non-repeatability</b>                                  | ≤ ± 0.1 % of the span  |
| <b>Response time (10 % ... 90 %)</b>                      | ≤ 1 ms ≤ 10 ms at medium temperatures below < -30 °C for pressure ranges up to 25 bar or with flush-mounted membrane       |
| <b>Long-term drift/one-year stability</b>                 | ≤ ± 0.2 % of span (at reference conditions)  |
| <b>Temperature coefficient in rated temperature range</b> | Mean TC of zero: ≤ 0.2 % of span / 10 K (< 0.4 % for pressure ranges ≤ 0.25 bar)<br>Mean TC of span ≤ 0.2 % of span / 10 K |
| <b>Rated temperature range</b>                            | 0 °C ... +80 °C  |
| <b>Service life</b>                                       | Minimum 10 Mio. load cycles  |

## Ambient data

|                            |  |
|----------------------------|--|
| <b>Ambient temperature</b> | -20 °C ... +80 °C  |
| <b>Storage temperature</b> | -20 °C ... +100 °C, with flush-mounted membrane and cooling element -20 °C ... +100 °C   |
| <b>Shock load</b>          | 1000 g according to IEC 60068-2-27 (mechanical shock)<br>400 g according to IEC 60068-2-27 (mechanical shock) for version with integrated cooling element              |
| <b>Vibration load</b>      | 20 g according to IEC 60068-2-6 (vibration under resonance)<br>10 g according to IEC 60068-2-6 (vibration undencr resonae) for version with integrated cooling element |

## Classifications

|                       |          |
|-----------------------|----------|
| <b>ECLASS 5.0</b>     | 27200614 |
| <b>ECLASS 5.1.4</b>   | 27200614 |
| <b>ECLASS 6.0</b>     | 27200614 |
| <b>ECLASS 6.2</b>     | 27200614 |
| <b>ECLASS 7.0</b>     | 27200614 |
| <b>ECLASS 8.0</b>     | 27200614 |
| <b>ECLASS 8.1</b>     | 27200614 |
| <b>ECLASS 9.0</b>     | 27200614 |
| <b>ECLASS 10.0</b>    | 27200614 |
| <b>ECLASS 11.0</b>    | 27200614 |
| <b>ECLASS 12.0</b>    | 27200614 |
| <b>ETIM 5.0</b>       | EC011478 |
| <b>ETIM 6.0</b>       | EC011478 |
| <b>ETIM 7.0</b>       | EC011478 |
| <b>ETIM 8.0</b>       | EC011478 |
| <b>UNSPSC 16.0901</b> | 41112410 |

**Dimensional drawing** (Dimensions in mm (inch))

G 1 B without cooling section

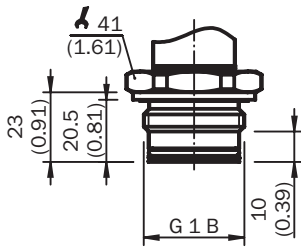

G 1 B with cooling section

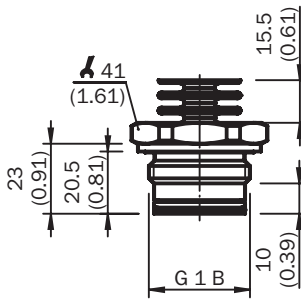

Housing with circular plug-in connector M12 x 1

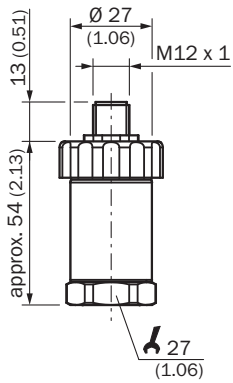



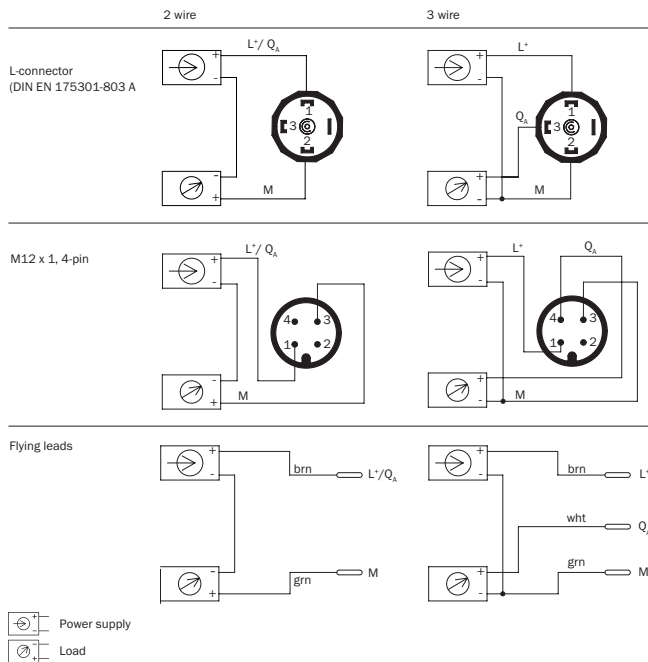







## Connection type



## Recommended accessories

Other models and accessories → [www.sick.com/PFT](http://www.sick.com/PFT)

|                                     | Brief description   | Type               | Part no. |
|-------------------------------------|---|--------------------|----------|
| <b>Flanges</b>                      |   |                    |          |
|                                     | Weld-in flange/weld-in socket for articles with flush-mounted membrane, process connection G 1 B, Stainless steel 1.4571  | BEF-FL-316G10-B0PH | 5322450  |
| <b>Mounting brackets and plates</b> |   |                    |          |
|                                     | Mounting bracket for simple and stable wall mounting of pressure sensors with 27 mm hexagon, Aluminum   | BEF-FL-ALUPBS-HLDR | 5322501  |
| <b>Others</b>                       |   |                    |          |
|                                     | <ul style="list-style-type: none"> <li><b>Connection type head A:</b> Female connector, M12, 4-pin, straight, A-coded</li> <li><b>Connection type head B:</b> Flying leads</li> <li><b>Signal type:</b> Sensor/actuator cable</li> <li><b>Cable:</b> 15 m, 4-wire, PUR, halogen-free</li> <li><b>Description:</b> Sensor/actuator cable, unshielded</li> <li><b>Application:</b> Zones with oils and lubricants, Drag chain operation, Robot</li> </ul> | YF2A14-150UB3XLEAX | 2095610  |
|                                     | <ul style="list-style-type: none"> <li><b>Connection type head A:</b> Female connector, M12, 4-pin, straight, A-coded</li> <li><b>Connection type head B:</b> Flying leads</li> <li><b>Signal type:</b> Sensor/actuator cable</li> <li><b>Cable:</b> 20 m, 4-wire, PUR, halogen-free</li> <li><b>Description:</b> Sensor/actuator cable, unshielded</li> <li><b>Application:</b> Zones with oils and lubricants, Drag chain operation, Robot</li> </ul> | YF2A14-200UB3XLEAX | 2095611  |

|   | Brief description   | Type               | Part no. |
|---|---|--------------------|----------|
|    | <ul style="list-style-type: none"> <li>• <b>Connection type head A:</b> Female connector, M12, 4-pin, straight, A-coded</li> <li>• <b>Connection type head B:</b> Flying leads</li> <li>• <b>Signal type:</b> Sensor/actuator cable</li> <li>• <b>Cable:</b> 25 m, 4-wire, PUR, halogen-free</li> <li>• <b>Description:</b> Sensor/actuator cable, unshielded</li> <li>• <b>Application:</b> Zones with oils and lubricants, Drag chain operation, Robot</li> </ul> | YF2A14-250UB3XLEAX | 2095615  |
|    | <ul style="list-style-type: none"> <li>• <b>Connection type head A:</b> Female connector, M12, 4-pin, angled, A-coded</li> <li>• <b>Connection type head B:</b> Flying leads</li> <li>• <b>Signal type:</b> Sensor/actuator cable</li> <li>• <b>Cable:</b> 15 m, 4-wire, PUR, halogen-free</li> <li>• <b>Description:</b> Sensor/actuator cable, unshielded</li> <li>• <b>Application:</b> Zones with oils and lubricants, Drag chain operation, Robot</li> </ul>   | YG2A14-150UB3XLEAX | 2095769  |
|    | <ul style="list-style-type: none"> <li>• <b>Connection type head A:</b> Female connector, M12, 4-pin, angled, A-coded</li> <li>• <b>Connection type head B:</b> Flying leads</li> <li>• <b>Signal type:</b> Sensor/actuator cable</li> <li>• <b>Cable:</b> 20 m, 4-wire, PUR, halogen-free</li> <li>• <b>Description:</b> Sensor/actuator cable, unshielded</li> <li>• <b>Application:</b> Zones with oils and lubricants, Drag chain operation, Robot</li> </ul>   | YG2A14-200UB3XLEAX | 2095770  |
|    | <ul style="list-style-type: none"> <li>• <b>Connection type head A:</b> Female connector, M12, 4-pin, angled, A-coded</li> <li>• <b>Connection type head B:</b> Flying leads</li> <li>• <b>Signal type:</b> Sensor/actuator cable</li> <li>• <b>Cable:</b> 25 m, 4-wire, PUR, halogen-free</li> <li>• <b>Description:</b> Sensor/actuator cable, unshielded</li> <li>• <b>Application:</b> Zones with oils and lubricants, Drag chain operation, Robot</li> </ul>   | YG2A14-250UB3XLEAX | 2095771  |
|    | <ul style="list-style-type: none"> <li>• <b>Connection type head A:</b> Female connector, M12, 4-pin, straight, A-coded</li> <li>• <b>Connection type head B:</b> Flying leads</li> <li>• <b>Signal type:</b> Sensor/actuator cable</li> <li>• <b>Cable:</b> 5 m, 4-wire, PVC</li> <li>• <b>Description:</b> Sensor/actuator cable, unshielded</li> <li>• <b>Application:</b> Zones with chemicals</li> </ul>   | YF2A14-050VB3XLEAX | 2096235  |
|  | <ul style="list-style-type: none"> <li>• <b>Connection type head A:</b> Female connector, M12, 4-pin, angled, A-coded</li> <li>• <b>Connection type head B:</b> Flying leads</li> <li>• <b>Signal type:</b> Sensor/actuator cable</li> <li>• <b>Cable:</b> 2 m, 4-wire, PVC</li> <li>• <b>Description:</b> Sensor/actuator cable, unshielded</li> <li>• <b>Application:</b> Zones with chemicals</li> </ul>   | YG2A14-020VB3XLEAX | 2095895  |
|  | <ul style="list-style-type: none"> <li>• <b>Connection type head A:</b> Female connector, M12, 4-pin, straight, A-coded</li> <li>• <b>Connection type head B:</b> Flying leads</li> <li>• <b>Signal type:</b> Sensor/actuator cable</li> <li>• <b>Cable:</b> 10 m, 4-wire, PVC</li> <li>• <b>Description:</b> Sensor/actuator cable, unshielded</li> <li>• <b>Application:</b> Zones with chemicals</li> </ul>  | YF2A14-100VB3XLEAX | 2096236  |
|  | <ul style="list-style-type: none"> <li>• <b>Connection type head A:</b> Female connector, M12, 4-pin, straight, A-coded</li> <li>• <b>Connection type head B:</b> Flying leads</li> <li>• <b>Signal type:</b> Sensor/actuator cable</li> <li>• <b>Cable:</b> 15 m, 4-wire, PVC</li> <li>• <b>Description:</b> Sensor/actuator cable, unshielded</li> <li>• <b>Application:</b> Zones with chemicals</li> </ul>  | YF2A14-150VB3XLEAX | 2096237  |
|  | <ul style="list-style-type: none"> <li>• <b>Connection type head A:</b> Female connector, M12, 4-pin, straight, A-coded</li> <li>• <b>Connection type head B:</b> Flying leads</li> <li>• <b>Signal type:</b> Sensor/actuator cable</li> <li>• <b>Cable:</b> 20 m, 4-wire, PVC</li> <li>• <b>Description:</b> Sensor/actuator cable, unshielded</li> <li>• <b>Application:</b> Zones with chemicals</li> </ul>  | YF2A14-200VB3XLEAX | 2096238  |
|  | <ul style="list-style-type: none"> <li>• <b>Connection type head A:</b> Female connector, M12, 4-pin, straight, A-coded</li> <li>• <b>Connection type head B:</b> Flying leads</li> <li>• <b>Signal type:</b> Sensor/actuator cable</li> <li>• <b>Cable:</b> 5 m, 4-wire, PUR, halogen-free</li> <li>• <b>Description:</b> Sensor/actuator cable, unshielded</li> <li>• <b>Application:</b> Zones with oils and lubricants, Drag chain operation, Robot</li> </ul>  | YF2A14-050UB3XLEAX | 2095608  |

|   | Brief description   | Type               | Part no. |
|---|---|--------------------|----------|
|    | <ul style="list-style-type: none"> <li><b>Connection type head A:</b> Female connector, M12, 4-pin, straight, A-coded</li> <li><b>Connection type head B:</b> Flying leads</li> <li><b>Signal type:</b> Sensor/actuator cable</li> <li><b>Cable:</b> 10 m, 4-wire, PUR, halogen-free</li> <li><b>Description:</b> Sensor/actuator cable, unshielded</li> <li><b>Application:</b> Zones with oils and lubricants, Drag chain operation, Robot</li> </ul> | YF2A14-100UB3XLEAX | 2095609  |
|    | <ul style="list-style-type: none"> <li><b>Connection type head A:</b> Female connector, M12, 4-pin, angled, A-coded</li> <li><b>Connection type head B:</b> Flying leads</li> <li><b>Signal type:</b> Sensor/actuator cable</li> <li><b>Cable:</b> 2 m, 4-wire, PUR, halogen-free</li> <li><b>Description:</b> Sensor/actuator cable, unshielded</li> <li><b>Application:</b> Zones with oils and lubricants, Drag chain operation, Robot</li> </ul>    | YG2A14-020UB3XLEAX | 2095766  |
|    | <ul style="list-style-type: none"> <li><b>Connection type head A:</b> Female connector, M12, 4-pin, angled, A-coded</li> <li><b>Connection type head B:</b> Flying leads</li> <li><b>Signal type:</b> Sensor/actuator cable</li> <li><b>Cable:</b> 5 m, 4-wire, PUR, halogen-free</li> <li><b>Description:</b> Sensor/actuator cable, unshielded</li> <li><b>Application:</b> Zones with oils and lubricants, Drag chain operation, Robot</li> </ul>    | YG2A14-050UB3XLEAX | 2095767  |
|    | <ul style="list-style-type: none"> <li><b>Connection type head A:</b> Female connector, M12, 4-pin, angled, A-coded</li> <li><b>Connection type head B:</b> Flying leads</li> <li><b>Signal type:</b> Sensor/actuator cable</li> <li><b>Cable:</b> 10 m, 4-wire, PUR, halogen-free</li> <li><b>Description:</b> Sensor/actuator cable, unshielded</li> <li><b>Application:</b> Zones with oils and lubricants, Drag chain operation, Robot</li> </ul>   | YG2A14-100UB3XLEAX | 2095768  |
|    | <ul style="list-style-type: none"> <li><b>Connection type head A:</b> Female connector, M12, 4-pin, straight, A-coded</li> <li><b>Connection type head B:</b> Flying leads</li> <li><b>Signal type:</b> Sensor/actuator cable</li> <li><b>Cable:</b> 2 m, 4-wire, PUR, halogen-free</li> <li><b>Description:</b> Sensor/actuator cable, unshielded</li> <li><b>Application:</b> Zones with oils and lubricants, Drag chain operation, Robot</li> </ul>  | YF2A14-020UB3XLEAX | 2095607  |
|  | <ul style="list-style-type: none"> <li><b>Connection type head A:</b> Female connector, M12, 4-pin, straight, A-coded</li> <li><b>Connection type head B:</b> Flying leads</li> <li><b>Signal type:</b> Sensor/actuator cable</li> <li><b>Cable:</b> 2 m, 4-wire, PVC</li> <li><b>Description:</b> Sensor/actuator cable, unshielded</li> <li><b>Application:</b> Zones with chemicals</li> </ul>   | YF2A14-020VB3XLEAX | 2096234  |
|  | <ul style="list-style-type: none"> <li><b>Connection type head A:</b> Female connector, M12, 4-pin, angled, A-coded</li> <li><b>Connection type head B:</b> Flying leads</li> <li><b>Signal type:</b> Sensor/actuator cable</li> <li><b>Cable:</b> 10 m, 4-wire, PVC</li> <li><b>Description:</b> Sensor/actuator cable, unshielded</li> <li><b>Application:</b> Zones with chemicals</li> </ul>  | YG2A14-100VB3XLEAX | 2095898  |
|  | <ul style="list-style-type: none"> <li><b>Connection type head A:</b> Female connector, M12, 4-pin, angled, A-coded</li> <li><b>Connection type head B:</b> Flying leads</li> <li><b>Signal type:</b> Sensor/actuator cable</li> <li><b>Cable:</b> 15 m, 4-wire, PVC</li> <li><b>Description:</b> Sensor/actuator cable, unshielded</li> <li><b>Application:</b> Zones with chemicals</li> </ul>  | YG2A14-150VB3XLEAX | 2096213  |
|  | <ul style="list-style-type: none"> <li><b>Connection type head A:</b> Female connector, M12, 4-pin, angled, A-coded</li> <li><b>Connection type head B:</b> Flying leads</li> <li><b>Signal type:</b> Sensor/actuator cable</li> <li><b>Cable:</b> 20 m, 4-wire, PVC</li> <li><b>Description:</b> Sensor/actuator cable, unshielded</li> <li><b>Application:</b> Zones with chemicals</li> </ul>  | YG2A14-200VB3XLEAX | 2096214  |
|  | <ul style="list-style-type: none"> <li><b>Connection type head A:</b> Female connector, M12, 4-pin, angled, A-coded</li> <li><b>Connection type head B:</b> Flying leads</li> <li><b>Signal type:</b> Sensor/actuator cable</li> <li><b>Cable:</b> 5 m, 4-wire, PVC</li> <li><b>Description:</b> Sensor/actuator cable, unshielded</li> <li><b>Application:</b> Zones with chemicals</li> </ul>   | YG2A14-050VB3XLEAX | 2095897  |

## SICK AT A GLANCE

SICK is one of the leading manufacturers of intelligent sensors and sensor solutions for industrial applications. A unique range of products and services creates the perfect basis for controlling processes securely and efficiently, protecting individuals from accidents and preventing damage to the environment.

We have extensive experience in a wide range of industries and understand their processes and requirements. With intelligent sensors, we can deliver exactly what our customers need. In application centers in Europe, Asia and North America, system solutions are tested and optimized in accordance with customer specifications. All this makes us a reliable supplier and development partner.

Comprehensive services complete our offering: SICK LifeTime Services provide support throughout the machine life cycle and ensure safety and productivity.

For us, that is “Sensor Intelligence.”

## WORLDWIDE PRESENCE:

Contacts and other locations –[www.sick.com](http://www.sick.com)