



# PFT-SRBX60SGDSSAAMSSZ

PFT

PRESSURE SENSORS

**SICK**  
Sensor Intelligence.



Illustration may differ



### Ordering information

Type	Part no.
PFT-SRBX60SGDSSAAMSSZ	6048785

Other models and accessories → [www.sick.com/PFT](http://www.sick.com/PFT)

### Detailed technical data

#### Features

<b>Medium</b>	Liquid, gaseous
<b>Pressure type</b>	Gauge pressure
<b>Pressure unit</b>	bar
<b>Measuring range</b>	0 bar ... 0.6 bar
<b>Process temperature</b>	-30 °C ... +100 °C
<b>Maximum ohmic load <math>R_A</math></b>	4 mA ... 20 mA, 2-wire ( $R_A \leq (L^+ - 10 \text{ V}) / 0.02 \text{ A [Ohm]}$ ) 0 V ... 5 V, 3-wire ( $R_A > 5 \text{ kOhm}$ ) 0 V ... 10 V, 3-wire ( $R_A > 10 \text{ kOhm}$ )
<b>Output signal</b>	4 mA ... 20 mA, 2-wire
<b>Specialty</b>	Without

#### Mechanics/electronics

<b>Process connection</b>	G ½ B according to EN 837
<b>Wetted parts</b>	Standard membrane: Stainless steel 1.4571, stainless steel 1.4534 for measuring ranges > 25 bar
<b>Internal transmission fluid</b>	Synthetic oil (Not available for version with standard membrane for pressure ranges > 25 bar)
<b>Pressure port</b>	Standard
<b>Housing material</b>	Stainless steel 1.4571
<b>Connection type</b>	M12 round connector x 1, 4-pin
<b>Supply voltage</b>	10 V DC ... 30 V DC
<b>Electrical safety</b>	Overvoltage protection: 36 V DC Short-circuit protection: $Q_A$ towards M Reverse polarity protection: $L^+$ to M Protection class: III
<b>Dielectric strength</b>	500 V DC, NEC Class O2 power supply (low voltage and low current max. 100 VA even in the event of a fault)
<b>CE-conformity</b>	Pressure equipment directive: 2014/68/EU EMC directive: 2004/108/EC, EN 61326-2-3
<b>Weight sensor</b>	Approx. 200 g

<sup>1)</sup> Enclosure rating IP per IEC 60529. The enclosure rating classes specified only apply when connected with female connectors that provide the corresponding enclosure rating.

<b>Seal</b>	Without seal
<b>Enclosure rating</b>	IP67 <sup>1)</sup>
<b>Protection class III</b>	✓
<b>MTTF</b>	403 years

<sup>1)</sup> Enclosure rating IP per IEC 60529. The enclosure rating classes specified only apply when connected with female connectors that provide the corresponding enclosure rating.

## Performance

<b>Non-linearity</b>	≤ ± 0.2 %, of span (Best Fit Straight Line, BFSL) according to IEC 61298-2
<b>Accuracy</b>	≤ ± 0.5 % of the span
<b>Non-repeatability</b>	≤ ± 0.1 % of the span
<b>Response time (10 % ... 90 %)</b>	≤ 1 ms ≤ 10 ms at medium temperatures below < -30 °C for pressure ranges up to 25 bar or with flush-mounted membrane
<b>Long-term drift/one-year stability</b>	≤ ± 0.2 % of span (at reference conditions)
<b>Temperature coefficient in rated temperature range</b>	Mean TC of zero: ≤ 0.2 % of span / 10 K (< 0.4 % for pressure ranges ≤ 0.25 bar) Mean TC of span ≤ 0.2 % of span / 10 K
<b>Rated temperature range</b>	0 °C ... +80 °C
<b>Service life</b>	Minimum 10 Mio. load cycles

## Ambient data

<b>Ambient temperature</b>	-20 °C ... +80 °C
<b>Storage temperature</b>	-40 °C ... +100 °C, with flush-mounted membrane and cooling element -20 °C ... +100 °C
<b>Shock load</b>	1000 g according to IEC 60068-2-27 (mechanical shock) 400 g according to IEC 60068-2-27 (mechanical shock) for version with integrated cooling element
<b>Vibration load</b>	20 g according to IEC 60068-2-6 (vibration under resonance) 10 g according to IEC 60068-2-6 (vibration under resonance) for version with integrated cooling element

## Classifications

<b>ECLASS 5.0</b>	27200614
<b>ECLASS 5.1.4</b>	27200614
<b>ECLASS 6.0</b>	27200614
<b>ECLASS 6.2</b>	27200614
<b>ECLASS 7.0</b>	27200614
<b>ECLASS 8.0</b>	27200614
<b>ECLASS 8.1</b>	27200614
<b>ECLASS 9.0</b>	27200614
<b>ECLASS 10.0</b>	27200614
<b>ECLASS 11.0</b>	27200614
<b>ECLASS 12.0</b>	27200614
<b>ETIM 5.0</b>	EC011478
<b>ETIM 6.0</b>	EC011478
<b>ETIM 7.0</b>	EC011478
<b>ETIM 8.0</b>	EC011478
<b>UNSPSC 16.0901</b>	41112410

**Dimensional drawing** (Dimensions in mm (inch))

Housing with circular plug-in connector M12 x 1



G ½ B according to EN 837

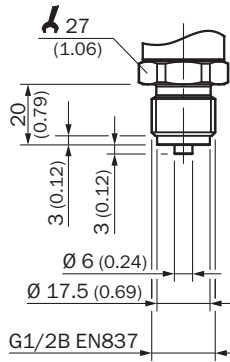



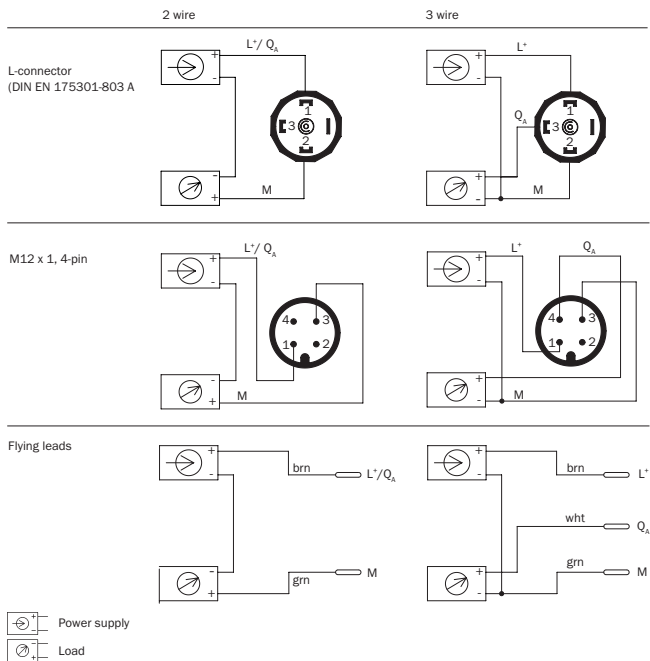









**Connection type**







## Recommended accessories

Other models and accessories → [www.sick.com/PFT](http://www.sick.com/PFT)

	Brief description	Type	Part no.
Heating and cooling devices			
	Cooling element, extension of the process temperature up to 150 °C. Maximum ambient temperature 30 °C. Max. process pressure 200 bar. Not suitable for pressure measurement in steam. Outer thread G 1/2, inner thread G 1/2.	BEF-CE-G12G12-150C	5324393
Mounting brackets and plates			
	Mounting bracket for simple and stable wall mounting of pressure sensors with 27 mm hexagon, Aluminum	BEF-FL-ALUPBS-HLDR	5322501
Others			
	<ul style="list-style-type: none"> <li><b>Connection type head A:</b> Female connector, M12, 4-pin, straight, A-coded</li> <li><b>Connection type head B:</b> Flying leads</li> <li><b>Signal type:</b> Sensor/actuator cable</li> <li><b>Cable:</b> 15 m, 4-wire, PUR, halogen-free</li> <li><b>Description:</b> Sensor/actuator cable, unshielded</li> <li><b>Application:</b> Zones with oils and lubricants, Drag chain operation, Robot</li> </ul>	YF2A14-150UB3XLEAX	2095610
	<ul style="list-style-type: none"> <li><b>Connection type head A:</b> Female connector, M12, 4-pin, straight, A-coded</li> <li><b>Connection type head B:</b> Flying leads</li> <li><b>Signal type:</b> Sensor/actuator cable</li> <li><b>Cable:</b> 20 m, 4-wire, PUR, halogen-free</li> <li><b>Description:</b> Sensor/actuator cable, unshielded</li> <li><b>Application:</b> Zones with oils and lubricants, Drag chain operation, Robot</li> </ul>	YF2A14-200UB3XLEAX	2095611
	<ul style="list-style-type: none"> <li><b>Connection type head A:</b> Female connector, M12, 4-pin, straight, A-coded</li> <li><b>Connection type head B:</b> Flying leads</li> <li><b>Signal type:</b> Sensor/actuator cable</li> <li><b>Cable:</b> 25 m, 4-wire, PUR, halogen-free</li> <li><b>Description:</b> Sensor/actuator cable, unshielded</li> <li><b>Application:</b> Zones with oils and lubricants, Drag chain operation, Robot</li> </ul>	YF2A14-250UB3XLEAX	2095615
	<ul style="list-style-type: none"> <li><b>Connection type head A:</b> Female connector, M12, 4-pin, angled, A-coded</li> <li><b>Connection type head B:</b> Flying leads</li> <li><b>Signal type:</b> Sensor/actuator cable</li> <li><b>Cable:</b> 15 m, 4-wire, PUR, halogen-free</li> <li><b>Description:</b> Sensor/actuator cable, unshielded</li> <li><b>Application:</b> Zones with oils and lubricants, Drag chain operation, Robot</li> </ul>	YG2A14-150UB3XLEAX	2095769
	<ul style="list-style-type: none"> <li><b>Connection type head A:</b> Female connector, M12, 4-pin, angled, A-coded</li> <li><b>Connection type head B:</b> Flying leads</li> <li><b>Signal type:</b> Sensor/actuator cable</li> <li><b>Cable:</b> 20 m, 4-wire, PUR, halogen-free</li> <li><b>Description:</b> Sensor/actuator cable, unshielded</li> <li><b>Application:</b> Zones with oils and lubricants, Drag chain operation, Robot</li> </ul>	YG2A14-200UB3XLEAX	2095770
	<ul style="list-style-type: none"> <li><b>Connection type head A:</b> Female connector, M12, 4-pin, angled, A-coded</li> <li><b>Connection type head B:</b> Flying leads</li> <li><b>Signal type:</b> Sensor/actuator cable</li> <li><b>Cable:</b> 25 m, 4-wire, PUR, halogen-free</li> <li><b>Description:</b> Sensor/actuator cable, unshielded</li> <li><b>Application:</b> Zones with oils and lubricants, Drag chain operation, Robot</li> </ul>	YG2A14-250UB3XLEAX	2095771
	<ul style="list-style-type: none"> <li><b>Connection type head A:</b> Female connector, M12, 4-pin, straight, A-coded</li> <li><b>Connection type head B:</b> Flying leads</li> <li><b>Signal type:</b> Sensor/actuator cable</li> <li><b>Cable:</b> 5 m, 4-wire, PVC</li> <li><b>Description:</b> Sensor/actuator cable, unshielded</li> <li><b>Application:</b> Zones with chemicals</li> </ul>	YF2A14-050VB3XLEAX	2096235

	Brief description	Type	Part no.
	<ul style="list-style-type: none"> <li>• <b>Connection type head A:</b> Female connector, M12, 4-pin, angled, A-coded</li> <li>• <b>Connection type head B:</b> Flying leads</li> <li>• <b>Signal type:</b> Sensor/actuator cable</li> <li>• <b>Cable:</b> 2 m, 4-wire, PVC</li> <li>• <b>Description:</b> Sensor/actuator cable, unshielded</li> <li>• <b>Application:</b> Zones with chemicals</li> </ul>	YG2A14-020VB3XLEAX	2095895
	<ul style="list-style-type: none"> <li>• <b>Connection type head A:</b> Female connector, M12, 4-pin, straight, A-coded</li> <li>• <b>Connection type head B:</b> Flying leads</li> <li>• <b>Signal type:</b> Sensor/actuator cable</li> <li>• <b>Cable:</b> 10 m, 4-wire, PVC</li> <li>• <b>Description:</b> Sensor/actuator cable, unshielded</li> <li>• <b>Application:</b> Zones with chemicals</li> </ul>	YF2A14-100VB3XLEAX	2096236
	<ul style="list-style-type: none"> <li>• <b>Connection type head A:</b> Female connector, M12, 4-pin, straight, A-coded</li> <li>• <b>Connection type head B:</b> Flying leads</li> <li>• <b>Signal type:</b> Sensor/actuator cable</li> <li>• <b>Cable:</b> 15 m, 4-wire, PVC</li> <li>• <b>Description:</b> Sensor/actuator cable, unshielded</li> <li>• <b>Application:</b> Zones with chemicals</li> </ul>	YF2A14-150VB3XLEAX	2096237
	<ul style="list-style-type: none"> <li>• <b>Connection type head A:</b> Female connector, M12, 4-pin, straight, A-coded</li> <li>• <b>Connection type head B:</b> Flying leads</li> <li>• <b>Signal type:</b> Sensor/actuator cable</li> <li>• <b>Cable:</b> 20 m, 4-wire, PVC</li> <li>• <b>Description:</b> Sensor/actuator cable, unshielded</li> <li>• <b>Application:</b> Zones with chemicals</li> </ul>	YF2A14-200VB3XLEAX	2096238
	<ul style="list-style-type: none"> <li>• <b>Connection type head A:</b> Female connector, M12, 4-pin, straight, A-coded</li> <li>• <b>Connection type head B:</b> Flying leads</li> <li>• <b>Signal type:</b> Sensor/actuator cable</li> <li>• <b>Cable:</b> 5 m, 4-wire, PUR, halogen-free</li> <li>• <b>Description:</b> Sensor/actuator cable, unshielded</li> <li>• <b>Application:</b> Zones with oils and lubricants, Drag chain operation, Robot</li> </ul>	YF2A14-050UB3XLEAX	2095608
	<ul style="list-style-type: none"> <li>• <b>Connection type head A:</b> Female connector, M12, 4-pin, straight, A-coded</li> <li>• <b>Connection type head B:</b> Flying leads</li> <li>• <b>Signal type:</b> Sensor/actuator cable</li> <li>• <b>Cable:</b> 10 m, 4-wire, PUR, halogen-free</li> <li>• <b>Description:</b> Sensor/actuator cable, unshielded</li> <li>• <b>Application:</b> Zones with oils and lubricants, Drag chain operation, Robot</li> </ul>	YF2A14-100UB3XLEAX	2095609
	<ul style="list-style-type: none"> <li>• <b>Connection type head A:</b> Female connector, M12, 4-pin, angled, A-coded</li> <li>• <b>Connection type head B:</b> Flying leads</li> <li>• <b>Signal type:</b> Sensor/actuator cable</li> <li>• <b>Cable:</b> 2 m, 4-wire, PUR, halogen-free</li> <li>• <b>Description:</b> Sensor/actuator cable, unshielded</li> <li>• <b>Application:</b> Zones with oils and lubricants, Drag chain operation, Robot</li> </ul>	YG2A14-020UB3XLEAX	2095766
	<ul style="list-style-type: none"> <li>• <b>Connection type head A:</b> Female connector, M12, 4-pin, angled, A-coded</li> <li>• <b>Connection type head B:</b> Flying leads</li> <li>• <b>Signal type:</b> Sensor/actuator cable</li> <li>• <b>Cable:</b> 5 m, 4-wire, PUR, halogen-free</li> <li>• <b>Description:</b> Sensor/actuator cable, unshielded</li> <li>• <b>Application:</b> Zones with oils and lubricants, Drag chain operation, Robot</li> </ul>	YG2A14-050UB3XLEAX	2095767
	<ul style="list-style-type: none"> <li>• <b>Connection type head A:</b> Female connector, M12, 4-pin, angled, A-coded</li> <li>• <b>Connection type head B:</b> Flying leads</li> <li>• <b>Signal type:</b> Sensor/actuator cable</li> <li>• <b>Cable:</b> 10 m, 4-wire, PUR, halogen-free</li> <li>• <b>Description:</b> Sensor/actuator cable, unshielded</li> <li>• <b>Application:</b> Zones with oils and lubricants, Drag chain operation, Robot</li> </ul>	YG2A14-100UB3XLEAX	2095768
	<ul style="list-style-type: none"> <li>• <b>Connection type head A:</b> Female connector, M12, 4-pin, straight, A-coded</li> <li>• <b>Connection type head B:</b> Flying leads</li> <li>• <b>Signal type:</b> Sensor/actuator cable</li> <li>• <b>Cable:</b> 2 m, 4-wire, PUR, halogen-free</li> <li>• <b>Description:</b> Sensor/actuator cable, unshielded</li> <li>• <b>Application:</b> Zones with oils and lubricants, Drag chain operation, Robot</li> </ul>	YF2A14-020UB3XLEAX	2095607

	Brief description	Type	Part no.
	<ul style="list-style-type: none"> <li>• <b>Connection type head A:</b> Female connector, M12, 4-pin, straight, A-coded</li> <li>• <b>Connection type head B:</b> Flying leads</li> <li>• <b>Signal type:</b> Sensor/actuator cable</li> <li>• <b>Cable:</b> 2 m, 4-wire, PVC</li> <li>• <b>Description:</b> Sensor/actuator cable, unshielded</li> <li>• <b>Application:</b> Zones with chemicals</li> </ul>	YF2A14-020VB3XLEAX	2096234
	<ul style="list-style-type: none"> <li>• <b>Connection type head A:</b> Female connector, M12, 4-pin, angled, A-coded</li> <li>• <b>Connection type head B:</b> Flying leads</li> <li>• <b>Signal type:</b> Sensor/actuator cable</li> <li>• <b>Cable:</b> 10 m, 4-wire, PVC</li> <li>• <b>Description:</b> Sensor/actuator cable, unshielded</li> <li>• <b>Application:</b> Zones with chemicals</li> </ul>	YG2A14-100VB3XLEAX	2095898
	<ul style="list-style-type: none"> <li>• <b>Connection type head A:</b> Female connector, M12, 4-pin, angled, A-coded</li> <li>• <b>Connection type head B:</b> Flying leads</li> <li>• <b>Signal type:</b> Sensor/actuator cable</li> <li>• <b>Cable:</b> 15 m, 4-wire, PVC</li> <li>• <b>Description:</b> Sensor/actuator cable, unshielded</li> <li>• <b>Application:</b> Zones with chemicals</li> </ul>	YG2A14-150VB3XLEAX	2096213
	<ul style="list-style-type: none"> <li>• <b>Connection type head A:</b> Female connector, M12, 4-pin, angled, A-coded</li> <li>• <b>Connection type head B:</b> Flying leads</li> <li>• <b>Signal type:</b> Sensor/actuator cable</li> <li>• <b>Cable:</b> 20 m, 4-wire, PVC</li> <li>• <b>Description:</b> Sensor/actuator cable, unshielded</li> <li>• <b>Application:</b> Zones with chemicals</li> </ul>	YG2A14-200VB3XLEAX	2096214
	<ul style="list-style-type: none"> <li>• <b>Connection type head A:</b> Female connector, M12, 4-pin, angled, A-coded</li> <li>• <b>Connection type head B:</b> Flying leads</li> <li>• <b>Signal type:</b> Sensor/actuator cable</li> <li>• <b>Cable:</b> 5 m, 4-wire, PVC</li> <li>• <b>Description:</b> Sensor/actuator cable, unshielded</li> <li>• <b>Application:</b> Zones with chemicals</li> </ul>	YG2A14-050VB3XLEAX	2095897

## SICK AT A GLANCE

SICK is one of the leading manufacturers of intelligent sensors and sensor solutions for industrial applications. A unique range of products and services creates the perfect basis for controlling processes securely and efficiently, protecting individuals from accidents and preventing damage to the environment.

We have extensive experience in a wide range of industries and understand their processes and requirements. With intelligent sensors, we can deliver exactly what our customers need. In application centers in Europe, Asia and North America, system solutions are tested and optimized in accordance with customer specifications. All this makes us a reliable supplier and development partner.

Comprehensive services complete our offering: SICK LifeTime Services provide support throughout the machine life cycle and ensure safety and productivity.

For us, that is “Sensor Intelligence.”

## WORLDWIDE PRESENCE:

Contacts and other locations –[www.sick.com](http://www.sick.com)