



PHT-RBX60S640S0AFT0Z

PHT

PRESSURE SENSORS

SICK
Sensor Intelligence.



Illustration may differ



Ordering information

Type	Part no.
PHT-RBX60S640S0AFT0Z	6039439

Other models and accessories → www.sick.com/PHT

Detailed technical data

Features

Medium	Liquid, gaseous
Pressure type	Gauge pressure
Pressure unit	bar
Measuring range	0 bar ... 0.6 bar
Process temperature	-20 °C ... +150 °C
Maximum ohmic load R_A	4 mA ... 20 mA, 2-wire ($R_A \leq (L^+ - 10 \text{ V}) / 0.02 \text{ A [Ohm]}$) The variant with field housing and current output 4 mA ... 20 mA features test terminals that allow metering of the signal current without having to disconnect the device. 0 V ... 10 V, 3-wire ($R_A > 10 \text{ kOhm}$) 0 V ... 5 V, 3-wire ($R_A > 5 \text{ kOhm}$)
Output signal	4 mA ... 20 mA, 2-wire

Mechanics/electronics

Process connection	Coupling (DIN 11864-1) DN 40 form A with union nut
Wetted parts	Stainless steel 1.4435
Internal transmission fluid	Synthetic oil, FDA approved
Housing material	Stainless steel 1.4571
Connection type	Field housing
Supply voltage	11 V DC ... 30 V DC
Electrical safety	Overvoltage protection: 36 V DC Short-circuit protection: Q_A towards M Reverse polarity protection: L^+ to M Protection class: III
Dielectric strength	500 V DC, NEC Class O2 power supply (low voltage and low current max. 100 VA even in the event of a fault)
CE-conformity	EMC directive: 2004/108/EC, EN 61326-2-3
Weight sensor	Approx. 500 g
Seal	Without seal
Enclosure rating	IP67 ¹⁾

¹⁾ Enclosure rating IP per IEC 60529. The enclosure rating classes specified only apply when connected with female connectors that provide the corresponding enclosure rating.

Protection class III	✓
MTTF	403 years

¹⁾ Enclosure rating IP per IEC 60529. The enclosure rating classes specified only apply when connected with female connectors that provide the corresponding enclosure rating.

Performance

Non-linearity	≤ ± 0.2 %, of span (Best Fit Straight Line, BFSL) according to IEC 61298-2
Accuracy	≤ ± 0.5 % of the span
Non-repeatability	≤ ± 0.1 % of the span
Response time (10 % ... 90 %)	≤ 10 ms
Long-term drift/one-year stability	≤ 0.2 % of the span
Temperature coefficient in rated temperature range	Mean TC of zero: ≤ 0.2% of span / 10 K for measuring ranges 0 bar ... 0.6 bar up to 0 bar ... 25 bar Mean TC of zero: ≤ 0.25 % of span/ 10 K with pressure range 0 bar ... 0.4 bar ≤ 0.25 % of span/ 10 K, with pressure range 0 bar ... 0.4 bar Mean TC of zero: ≤ 0.4% of span / 10 K for measuring range 0 bar ... 0.25 bar Mean TC of span ≤ 0.2 % of span / 10 K
Rated temperature range	0 °C ... +80 °C

Ambient data

Ambient temperature	-20 °C ... +80 °C
Storage temperature	-40 °C ... +100 °C
Shock load	500 g according to IEC 60068-2-27 (mechanical shock)
Vibration load	15 g according to IEC 60068-2-6 (vibration under resonance)

Classifications

ECLASS 5.0	27200614
ECLASS 5.1.4	27200614
ECLASS 6.0	27200614
ECLASS 6.2	27200614
ECLASS 7.0	27200614
ECLASS 8.0	27200614
ECLASS 8.1	27200614
ECLASS 9.0	27200614
ECLASS 10.0	27200614
ECLASS 11.0	27200614
ECLASS 12.0	27200614
ETIM 5.0	EC011478
ETIM 6.0	EC011478
ETIM 7.0	EC011478
ETIM 8.0	EC011478
UNSPSC 16.0901	41112410

Dimensional drawing (Dimensions in mm (inch))

Stainless steel field case, compression fitting copper alloy, nickel plated, IP67

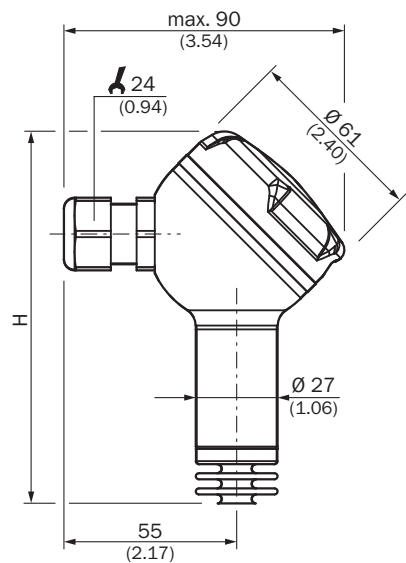

With accuracy	H
0.5 %	123 (4.84)
0.25 %	138.5 (5.45)

Coupling (DIN 11864-1) form A with union nut

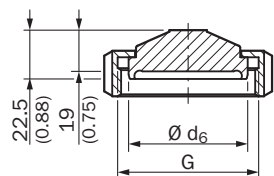

Design	G	Ø d ₆
DIN 11864-1 DN 40	Rd 65 x 1/6	54.9 (2.16)
DN 50	Rd 78 x 1/6	66.9 (2.63)

Connection type



SICK AT A GLANCE

SICK is one of the leading manufacturers of intelligent sensors and sensor solutions for industrial applications. A unique range of products and services creates the perfect basis for controlling processes securely and efficiently, protecting individuals from accidents and preventing damage to the environment.

We have extensive experience in a wide range of industries and understand their processes and requirements. With intelligent sensors, we can deliver exactly what our customers need. In application centers in Europe, Asia and North America, system solutions are tested and optimized in accordance with customer specifications. All this makes us a reliable supplier and development partner.

Comprehensive services complete our offering: SICK LifeTime Services provide support throughout the machine life cycle and ensure safety and productivity.

For us, that is “Sensor Intelligence.”

WORLDWIDE PRESENCE:

Contacts and other locations –www.sick.com