



PLG3-420F431

PLG

SWITCHING AUTOMATION LIGHT GRIDS

SICK
Sensor Intelligence.



Illustration may differ



Ordering information

Type	Part no.
PLG3-420F431	1029132

Other models and accessories → www.sick.com/PLG

Detailed technical data

Features

Sensor principle	Photoelectric retro-reflective sensor
Minimum detectable object (MDO)	35 mm ¹⁾
Beam separation	30 mm
Number of beams	15
Detection height	420 mm

¹⁾ See characteristic curve.

Mechanics/electronics

Wave length	650 nm
Supply voltage V_s	DC 15 V ... 30 V ¹⁾
Power consumption sender	< 45 mA
Ripple	< 5 V _{pp}
Output current I_{max.}	≤ 100 mA
Output load, capacitive	100 nF
Output load, Inductive	1 H
Initialization time	0.6 s
Switching output	PNP ²⁾
Output mode	Q dark switching ³⁾
Current consumption job LED	10 mA ¹⁾
Dimensions (W x H x D)	19.2 mm x 499.8 mm x 36.6 mm
Connection type	Cable with M12 male connector, 4-pin, 280 mm
Housing material	Aluminum
Indication	LED

¹⁾ Typical value.

²⁾ Q.

³⁾ Q = active, if at least one beam is interrupted, /Q = active, if all of the beams are free.

Enclosure rating	IP54
Circuit protection	U _v connections, reverse polarity protected Output Q short-circuit protected Interference pulse suppression
Protection class	III
Weight	500 g
Front screen	PMMA

1) Typical value.

2) Q.

3) Q = active, if at least one beam is interrupted, /Q = active, if all of the beams are free.

Performance

Maximum range	2 m
Minimum range	≥ 110 mm
Operating range	1.3 m
Response time	< 80 ms ¹⁾

1) With resistive load.

Ambient data

Shock resistance	10 g / DIN EN 60068-2-29 / 16 ms
Vibration resistance	5 g, 10 Hz ... 55 Hz (IEC 68-2-6)
EMC	EN 60947-5-2
Ambient operating temperature	-10 °C ... +55 °C
Ambient temperature, storage	-40 °C ... +70 °C

Classifications

ECLASS 5.0	27270910
ECLASS 5.1.4	27270910
ECLASS 6.0	27270910
ECLASS 6.2	27270910
ECLASS 7.0	27270910
ECLASS 8.0	27270910
ECLASS 8.1	27270910
ECLASS 9.0	27270910
ECLASS 10.0	27270910
ECLASS 11.0	27270910
ECLASS 12.0	27270910
ETIM 5.0	EC002549
ETIM 6.0	EC002549
ETIM 7.0	EC002549
ETIM 8.0	EC002549
UNSPSC 16.0901	39121528

Dimensional drawing (Dimensions in mm (inch))

PLG3

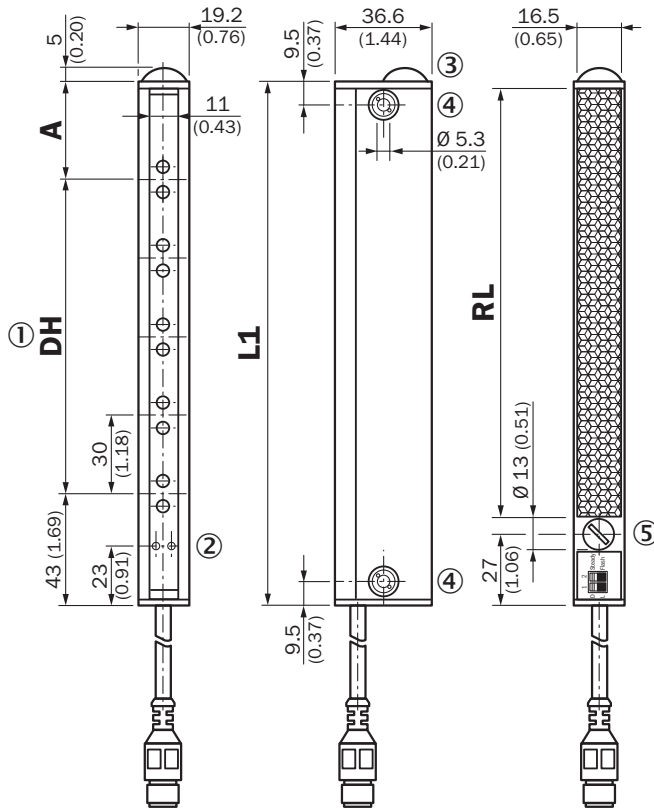

DH	A	L1	RL
120 (4.72)	36 (1.42)	199.8 (7.87)	162 (6.38)
210 (8.27)	26 (1.02)	279.8 (11.02)	242 (9.53)
270 (10.63)	36 (1.42)	349.8 (13.77)	312 (12.28)
360 (14.17)	26 (1.02)	429.8 (16.92)	392 (15.43)
420 (16.54)	36 (1.42)	499.8 (19.68)	462 (18.19)

- ① Detection height (DH)
- ② Indicator Power on: green; beam status: yellow
- ③ Job LED, green
- ④ Mounting hole, Ø 5.3 mm
- ⑤ Configuration switches

Connection type and diagram

Connection type and diagram

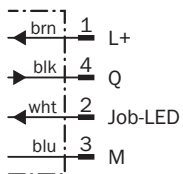
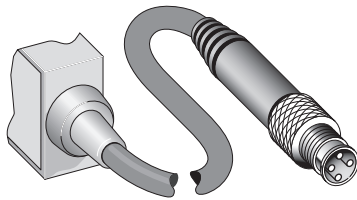

Adjustments

PLG3

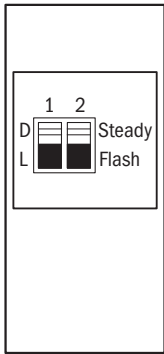

Configuration over switches

Switch 1	D	Output active, in case of blocked beams
	L	Output inactive, in case of blocked beams
Switch 2	Steady	Job-LED steady
	Flash	Job-LED flashes, 3 Hz

Concept of operation

Specific features

Easy installation

1. Easy mounting on to different profiles

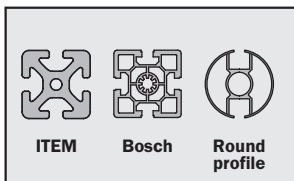

The light grid can be mounted on different profiles, e.g. ITEM, Bosch, round profile.

2. Easy installation with slot nuts



The PLG can easily be mounted on the profile with slot nuts.

Plug & play

1. Plug in and tighten the ring of the connector

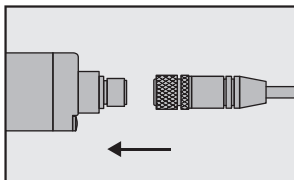

2. Device is ready for use

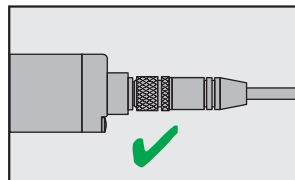

Sensing distance

Characteristic curve: range

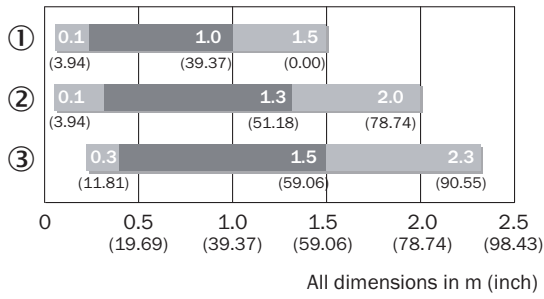

- ① REF-PLG
- ② Reflector PL150
- ③ Reflector PL180

Detection capability

PLG3

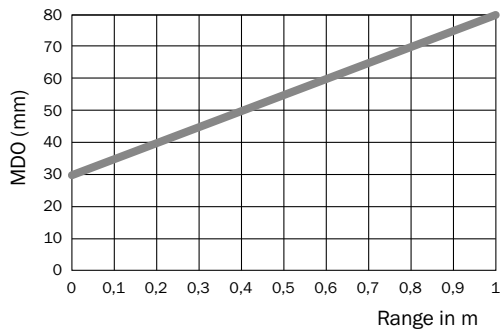



Recommended accessories

Other models and accessories → www.sick.com/PLG

	Brief description	Type	Part no.
Other mounting accessories			
	Sliding nuts with spring metal ball for ITEM profile, 2x slot 6 and slot 8, including mounting material, Mounting hardware included with every 2 x slot 6 and slot 8	BEF-NSIT-PLG	2041045

¹⁾ Customizable length by roll. Width 2.5 cm, length max. 22.8 m.

	Brief description	Type	Part no.
Reflectors			
	Reflective tape on aluminium profile, 16.5 mm x 494.3 mm, 2 hole mounting, Screw-on, 2 hole mounting	REF-PLG420	1029200
	Self-adhesive, customizable length by roll, 2.5 cm x 22.8 m ¹⁾ , self-adhesive	REF-PLUS-R25-K	4051184
Others			
	<ul style="list-style-type: none"> • Connection type head A: Female connector, M12, 4-pin, straight, A-coded • Connection type head B: Flying leads • Signal type: Sensor/actuator cable • Cable: 5 m, 4-wire, PVC • Description: Sensor/actuator cable, unshielded • Application: Zones with chemicals 	YF2A14-050VB3XLEAX	2096235

¹⁾ Customizable length by roll. Width 2.5 cm, length max. 22.8 m.

SICK AT A GLANCE

SICK is one of the leading manufacturers of intelligent sensors and sensor solutions for industrial applications. A unique range of products and services creates the perfect basis for controlling processes securely and efficiently, protecting individuals from accidents and preventing damage to the environment.

We have extensive experience in a wide range of industries and understand their processes and requirements. With intelligent sensors, we can deliver exactly what our customers need. In application centers in Europe, Asia and North America, system solutions are tested and optimized in accordance with customer specifications. All this makes us a reliable supplier and development partner.

Comprehensive services complete our offering: SICK LifeTime Services provide support throughout the machine life cycle and ensure safety and productivity.

For us, that is “Sensor Intelligence.”

WORLDWIDE PRESENCE:

Contacts and other locations –www.sick.com