

PM3C17-00030000

Mirror columns with protective field height mirror

COLUMNS FOR SAFETY LIGHT CURTAINS

SICK
Sensor Intelligence.

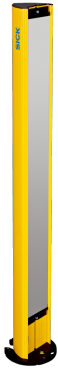

Illustration may differ

Ordering information

Column height	Suitable for deTec safety light curtain	Suitable for C2000, C4000 and M4000 Curtain safety light curtain	Suitable for deTem safety light-beam sensor	Suitable for M2000 and M4000 safety light-beam sensor	Type	Part no.
1,716.5 mm	Protective field height ≤ 1,500 mm	Protective field height ≤ 1,500 mm	Any	Any	PM3C17-00030000	1043454

Other models and accessories → www.sick.com/Mirror_columns_with_protective_field_height_mirror

Detailed technical data

Features

Description	PM3 mirror column with fixed mirror for beam deflection. Allows multi-sided access protection.
Mounting system type	Mechanical anchoring to the floor
Items supplied	PM3 mirror column with pre-assembled base plate
Column height	1,716.5 mm
Mirror height	1,532 mm
Suitable for device variants	
deTec safety light curtain	Protective field height ≤ 1,500 mm
C2000, C4000, M4000 Curtain safety light curtain	Protective field height ≤ 1,500 mm
deTem safety light-beam sensor	Any
M2000, M4000 safety light-beam sensor	Any

Mechanical data

Dimensions	See dimensional drawing
L1	1,532 mm ¹⁾
L2	145 mm ²⁾
L5	1,716.5 mm ³⁾
Cross-section of column profile	148 mm x 118 mm
Diameter of base plate	180 mm
Weight	12.65 kg

¹⁾ L1 = Mirror height.

²⁾ L2 = Distance of bottom end of mirror from floor.

³⁾ L5 = Column height (incl. base plate).

Classifications

ECLASS 5.0	27279203
ECLASS 5.1.4	27279203
ECLASS 6.0	27279203
ECLASS 6.2	27279203

ECLASS 7.0	27279203
ECLASS 8.0	27279203
ECLASS 8.1	27279203
ECLASS 9.0	27273601
ECLASS 10.0	27273601
ECLASS 11.0	27273601
ECLASS 12.0	27273601
ETIM 5.0	EC002467
ETIM 6.0	EC002467
ETIM 7.0	EC002467
ETIM 8.0	EC002467
UNSPSC 16.0901	39111609

Dimensional drawing (Dimensions in mm (inch))

PM3

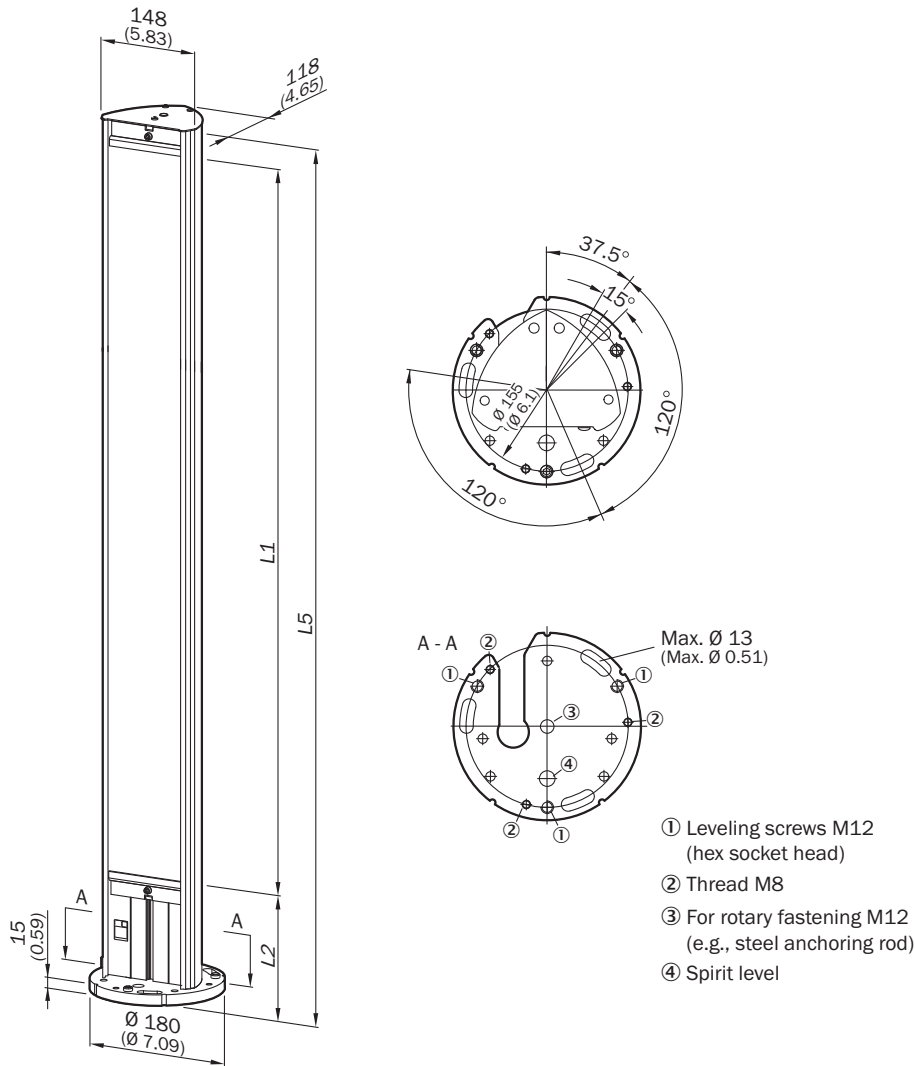

- ① Leveling screws M12 (hex socket head)
- ② Thread M8
- ③ For rotary fastening M12 (e.g., steel anchoring rod)
- ④ Spirit level

Type	Part no.	L1 = Mirror height	L2 = Distance of bottom end of mirror from floor	L5 = Column height (incl. base plate)	Suitable for protective field height
PM3C13-00030000	1043453	1.082	160	1.281,5	≤ 1.050
PM3C15-00030000	1077525	1.382	145	1.569	≤ 1.350
PM3C17-00030000	1043454	1.532	145	1.716,5	≤ 1.500
PM3C19-00030000	1043455	1.682	295	2.016,5	≤ 1.650
PM3C20-00030000	1043456	1.832	345	2.216,5	≤ 1.800
PM3C22-00030000	1093216	1.982	245	2.269	≤ 1.950
PM3C24-00030000	1093217	2.132	245	2.419	≤ 2.100

SICK AT A GLANCE

SICK is one of the leading manufacturers of intelligent sensors and sensor solutions for industrial applications. A unique range of products and services creates the perfect basis for controlling processes securely and efficiently, protecting individuals from accidents and preventing damage to the environment.

We have extensive experience in a wide range of industries and understand their processes and requirements. With intelligent sensors, we can deliver exactly what our customers need. In application centers in Europe, Asia and North America, system solutions are tested and optimized in accordance with customer specifications. All this makes us a reliable supplier and development partner.

Comprehensive services complete our offering: SICK LifeTime Services provide support throughout the machine life cycle and ensure safety and productivity.

For us, that is “Sensor Intelligence.”

WORLDWIDE PRESENCE:

Contacts and other locations –www.sick.com