



# PSN02-3301

deTem

**SAFETY MULTIBEAM SENSORS**

**SICK**  
Sensor Intelligence.



### Ordering information

deTem4 A/P

Scanning range	Number of beams	Beam separation	System part	Type	Part no.
7 m	4	300 mm	Passive unit	PSN02-3301	1103067

Other models and accessories → [www.sick.com/deTem](http://www.sick.com/deTem)



### Detailed technical data

#### Features

<b>Sub product family</b>	deTem4 A/P
<b>Application</b>	Normal industrial environment
<b>Functional principle</b>	Active/passive
<b>System part</b>	Passive unit
<b>Type of diversion</b>	Prism deflection
<b>Scanning range category</b>	Great scanning range
<b>Scanning range</b>	7 m
<b>Dimension of the light path</b>	Typical 0.5 m ... 7 m
<b>Number of beams</b>	4
<b>Beam separation</b>	300 mm
<b>Items supplied</b>	Passive unit

#### Mechanical data

<b>Dimensions</b>	See dimensional drawing
<b>Housing cross-section</b>	42.5 mm x 46.8 mm
<b>Material</b>	Housing PMMA
<b>Weight</b>	+ 950 g (± 50 g)

#### Ambient data

<b>Ambient operating temperature</b>	-30 °C ... +55 °C
<b>Storage temperature</b>	-30 °C ... +70 °C
<b>Air humidity</b>	15 % ... 95 %, Non-condensing
<b>Vibration resistance</b>	5 g, 10 Hz ... 55 Hz (IEC 60068-2-6)
<b>Shock resistance</b>	10 g, 16 ms (IEC 60068-2-27)

Classifications

<b>ECLASS 5.0</b>	27272703
<b>ECLASS 5.1.4</b>	27272703
<b>ECLASS 6.0</b>	27272703
<b>ECLASS 6.2</b>	27272703
<b>ECLASS 7.0</b>	27272703
<b>ECLASS 8.0</b>	27272703
<b>ECLASS 8.1</b>	27272703
<b>ECLASS 9.0</b>	27272703
<b>ECLASS 10.0</b>	27272703
<b>ECLASS 11.0</b>	27272703
<b>ECLASS 12.0</b>	27272703
<b>ETIM 5.0</b>	EC001832
<b>ETIM 6.0</b>	EC001832
<b>ETIM 7.0</b>	EC001832
<b>ETIM 8.0</b>	EC001832
<b>UNSPSC 16.0901</b>	46171620

Dimensional drawing (Dimensions in mm (inch))



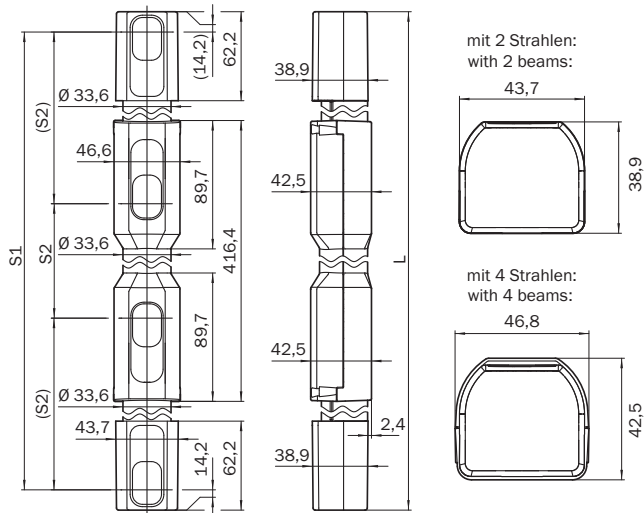



Passive unit for large sensing range (prism deflection)

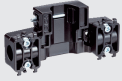

Number of beams	Beam separation S1	Beam separation S2	L
2	500	-	528,4
4	-	300	928,4

### Recommended accessories

Other models and accessories → [www.sick.com/deTem](http://www.sick.com/deTem)

	Brief description	Type	Part no.
<b>Muting accessories</b>			
	Sensor bracket G6 and P250	BEF-2KHAAAKU1	2113145
	Universal holder for round steel arms and muting arms, for mounting sensors or reflectors	BEF-KHS-N01	2044953
	Muting arm bracket for deTec safety light curtain or deTem safety multibeam sensor	Muting arm bracket	2106455
	Muting arm, long	Muting arm, long	2111923
	Muting arm, short	Muting arm, short	2111924
<b>Terminal and alignment brackets</b>			
	4 pieces, FlexFix bracket for 2 devices (e.g. sender and receiver), can be aligned $\pm 15^\circ$ , including M5 screw, plastic	BEF-1SHABPKU4	2066614
	4 pieces, QuickFix bracket for 2 devices (e.g. sender and receiver), plastic	BEF-3SHABPKU4	2098710

## SICK AT A GLANCE

SICK is one of the leading manufacturers of intelligent sensors and sensor solutions for industrial applications. A unique range of products and services creates the perfect basis for controlling processes securely and efficiently, protecting individuals from accidents and preventing damage to the environment.

We have extensive experience in a wide range of industries and understand their processes and requirements. With intelligent sensors, we can deliver exactly what our customers need. In application centers in Europe, Asia and North America, system solutions are tested and optimized in accordance with customer specifications. All this makes us a reliable supplier and development partner.

Comprehensive services complete our offering: SICK LifeTime Services provide support throughout the machine life cycle and ensure safety and productivity.

For us, that is “Sensor Intelligence.”

## WORLDWIDE PRESENCE:

Contacts and other locations –[www.sick.com](http://www.sick.com)