



RAY26P-1H162330A00

RAY26 Reflex Array

MULTITASK PHOTOELECTRIC SENSORS

SICK
Sensor Intelligence.



Illustration may differ



Ordering information

Type	Part no.
RAY26P-1H162330A00	1221945

Other models and accessories → www.sick.com/RAY26_Reflex_Array

Detailed technical data

Features

Functional principle	Photoelectric retro-reflective sensor
Functional principle detail	Without reflector minimum distance (autocollimation/coaxial optics), Reflex Array
Dimensions (W x H x D)	24.6 mm x 82.5 mm x 53.3 mm
Housing design (light emission)	Rectangular
Minimum object size	3 mm, position-independent detection within the light array (factory setting), adjustable via IO-Link incl. adjustable conveyor belt suppression 5 mm, position-independent detection within the light array, adjustable via IO-Link incl. adjustable conveyor belt suppression 10 mm, position-independent detection within the light array, adjustable via IO-Link incl. adjustable conveyor belt suppression
Detection height	55 mm
Sensing range max.	0 m ... 2 m ^{1) 2)} 0 m ... 3 m ^{1) 3)} 0 m ... 4.5 m ^{1) 4)}
Distance of the sensor to reflector	≥ 0 m
Conveyor belt suppression	Manual, via IO-Link
Type of light	Visible red light
Light source	PinPoint LED ⁵⁾

¹⁾ Reflector PL80A.

²⁾ At minimum object size 3 mm.

³⁾ At minimum object size 5 mm.

⁴⁾ At minimum object size 10 mm.

⁵⁾ Average service life: 100,000 h at T_J = +25 °C.

Light spot size (distance)	55 mm x 9 mm (1 m)
Wave length	635 nm
Adjustment	BluePilot: Teach-in, IO-Link
Pin 2 configuration	External Input (test), Teach-in, switching signal
AutoAdapt	✓
Special applications	Detecting objects with position tolerances, Detecting perforated objects, Detecting uneven, shiny objects, Detecting transparent objects, Detecting flat objects

1) Reflector PL80A.

2) At minimum object size 3 mm.

3) At minimum object size 5 mm.

4) At minimum object size 10 mm.

5) Average service life: 100,000 h at $T_U = +25\text{ °C}$.

Mechanics/electronics

Supply voltage U_B	10 V DC ... 30 V DC ¹⁾
Ripple	< 5 V _{pp}
Current consumption	25 mA, 40 mA ^{2) 3)}
Switching output	Push-pull: PNP/NPN ⁴⁾
Output: Q_{L1} / C	Switching output or IO-Link mode
Output function	Factory setting: Pin 2 / white (MF): NPN normally closed (light switching), PNP normally open (dark switching), Pin 4 / black (Q_{L1} / C): NPN normally open (dark switching), PNP normally closed (light switching), IO-Link
Switching mode	Light/dark switching
Switching mode selector	Via IO-Link
Signal voltage PNP HIGH/LOW	Approx. $V_S - 2.5\text{ V} / 0\text{ V}$
Signal voltage NPN HIGH/LOW	Approx. $V_S / < 2.5\text{ V}$
Output current I_{max}	≤ 100 mA
Response time	≤ 3 ms ⁵⁾
Switching frequency	170 Hz ⁶⁾
Connection type	Cable, 4-wire, 2 m ⁷⁾
Cable material	Plastic, PVC
Circuit protection	A ⁸⁾ B ⁹⁾ C ¹⁰⁾

1) Limit values.

2) 16 V DC ... 30 V DC, without load.

3) 10 V DC ... 16 V DC, without load.

4) Pin 4 and pin 2: This switching output must not be connected to another output.

5) Signal transit time with resistive load in switching mode. Different values possible in COM2 mode.

6) With light/dark ratio 1:1 in switching mode. Different values possible in IO-Link mode.

7) Do not bend below 0 °C.

8) A = V_S connections reverse-polarity protected.

9) B = inputs and output reverse-polarity protected.

10) C = interference suppression.

11) D = outputs overcurrent and short-circuit protected.

12) Avoid condensation on the front screen of the sensor and on the reflector.

13) Allowed temperature change after Teach +/- 20 K.

	D ¹¹⁾
Protection class	III
Weight	130 g
Housing material	Plastic, VISTAL®
Optics material	Plastic, PMMA
Enclosure rating	IP66 IP67
Ambient operating temperature	-40 °C ... +60 °C ^{12) 13)}
Ambient temperature, storage	-40 °C ... +75 °C
UL File No.	NRKH.E181493 & NRKH7.E181493

¹⁾ Limit values.

²⁾ 16 V DC ... 30 V DC, without load.

³⁾ 10 V DC ... 16 V DC, without load.

⁴⁾ Pin 4 and pin 2: This switching output must not be connected to another output.

⁵⁾ Signal transit time with resistive load in switching mode. Different values possible in COM2 mode.

⁶⁾ With light/dark ratio 1:1 in switching mode. Different values possible in IO-Link mode.

⁷⁾ Do not bend below 0 °C.

⁸⁾ A = V_S connections reverse-polarity protected.

⁹⁾ B = inputs and output reverse-polarity protected.

¹⁰⁾ C = interference suppression.

¹¹⁾ D = outputs overcurrent and short-circuit protected.

¹²⁾ Avoid condensation on the front screen of the sensor and on the reflector.

¹³⁾ Allowed temperature change after Teach +/- 20 K.

Safety-related parameters

MTTF_D	709 years
DC_{avg}	0 %

Communication interface

Communication interface	IO-Link V1.1
Communication Interface detail	COM2 (38,4 kBaud)
Cycle time	2.3 ms
Process data length	16 Bit
Process data structure	Bit 0 = switching signal Q _{L1} Bit 1 = switching signal Q _{L2} Bit 2 ... 15 = empty
VendorID	26
DeviceID HEX	0x800217
DeviceID DEC	8389143

Smart Task

Smart Task name	Base logics
Logic function	Direct AND OR Window Hysteresis

¹⁾ SIO Direct: sensor operation in standard I/O mode without IO-Link communication and without using internal sensor logic or time parameters (set to "direct"/"deactivated").

²⁾ SIO Logic: Sensor operation in standard I/O mode without IO-Link communication. Sensor-internal logic or timing parameters plus Automation Functions used.

³⁾ IOL: Sensor operation with full IO-Link communication and usage of logic, timing and Automation Function parameters.

Timer function	Deactivated Switch-on delay Off delay ON and OFF delay Impulse (one shot)
Inverter	Yes
Switching frequency	SIO Direct: 170 Hz ¹⁾ SIO Logic: 170 Hz ²⁾ IOL: 170 Hz ³⁾
Response time	SIO Direct: 3 ms ¹⁾ SIO Logic: 3 ms ²⁾ IOL: 3 ms ³⁾
Repeatability	SIO Direct: 1,5 ms ¹⁾ SIO Logic: 1,5 ms ²⁾ IOL: 1,5 ms ³⁾
Switching signal	
Switching signal Q _{L1}	Switching output
Switching signal Q _{L2}	Switching output

¹⁾ SIO Direct: sensor operation in standard I/O mode without IO-Link communication and without using internal sensor logic or time parameters (set to "direct"/"deactivated").

²⁾ SIO Logic: Sensor operation in standard I/O mode without IO-Link communication. Sensor-internal logic or timing parameters plus Automation Functions used.

³⁾ IOL: Sensor operation with full IO-Link communication and usage of logic, timing and Automation Function parameters.

Diagnosis

Device status	Yes
Quality of teach	Yes
Quality of run	Yes, Contamination display

Classifications

ECLASS 5.0	27270902
ECLASS 5.1.4	27270902
ECLASS 6.0	27270902
ECLASS 6.2	27270902
ECLASS 7.0	27270902
ECLASS 8.0	27270902
ECLASS 8.1	27270902
ECLASS 9.0	27270902
ECLASS 10.0	27270902
ECLASS 11.0	27270902
ECLASS 12.0	27270902
ETIM 5.0	EC002717
ETIM 6.0	EC002717
ETIM 7.0	EC002717
ETIM 8.0	EC002717
UNSPSC 16.0901	39121528

Connection diagram

Cd-389

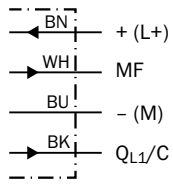

Light spot size

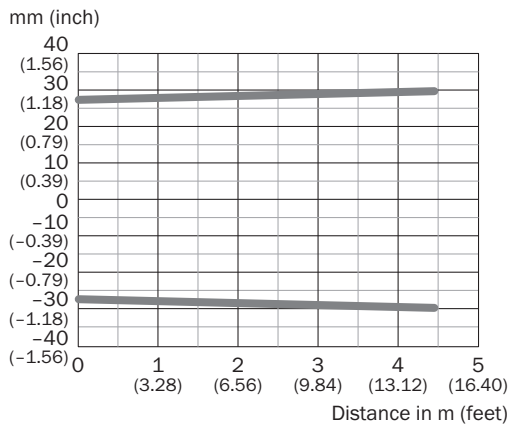

Sensing range diagram

Sensing range diagram (MDO 3 mm)

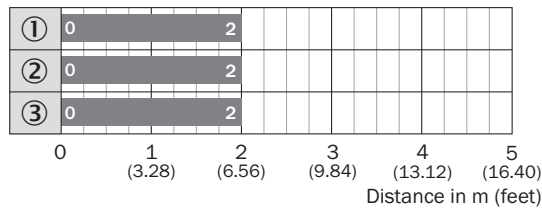

- Sensing range
- ① Reflector PL80A
- ② Reflector PL81
- ③ Reflector PL100

Sensing range diagram (MDO 10 mm)

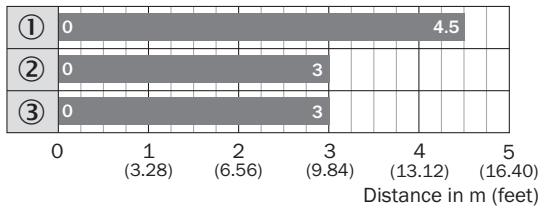

- Sensing range
- ① Reflector PL80A
- ② Reflector PL81
- ③ Reflector PL100

Sensing range diagram (MDO 5 mm)

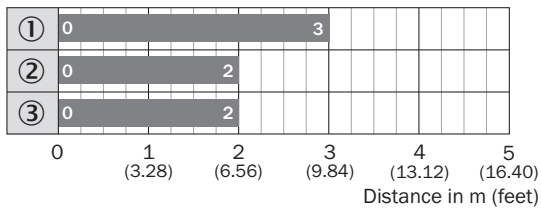

- Sensing range
- ① Reflector PL80A
- ② Reflector PL81
- ③ Reflector PL100

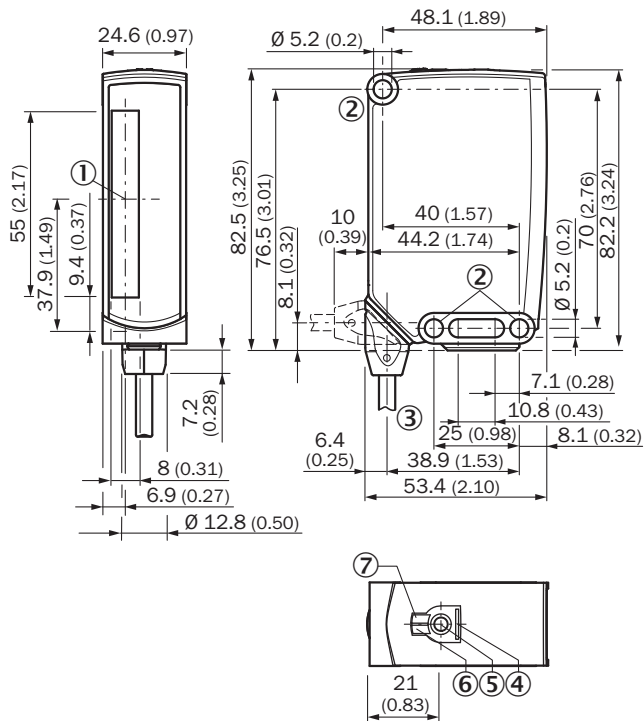

Dimensional drawing (Dimensions in mm (inch))



- ① Center of optical axis
- ② Mounting hole, \varnothing 5.2 mm
- ③ Connection
- ④ BluePilot blue: AutoAdapt indicator during run mode
- ⑤ Teach-in button
- ⑥ LED indicator yellow: Status of received light beam
- ⑦ LED indicator green: Supply voltage active

Recommended accessories

Other models and accessories → www.sick.com/RAY26_Reflex_Array

	Brief description	Type	Part no.
Mounting brackets and plates			
	Mounting bracket, steel, zinc coated, mounting hardware included	BEF-WN-W23	2019085
Reflectors			
	Rectangular, screw connection, 84 mm x 84 mm, PMMA/ABS, Screw-on, 2 hole mounting	PL80A	1003865
Others			
	<ul style="list-style-type: none"> • Connection type head A: Male connector, M12, 4-pin, straight, A-coded • Description: Unshielded • Connection systems: Screw-type terminals • Permitted cross-section: $\leq 0.75 \text{ mm}^2$ 	STE-1204-G	6009932

Recommended services

Additional services → www.sick.com/RAY26_Reflex_Array

	Type	Part no.
Function Block Factory		
<ul style="list-style-type: none"> Description: The Function Block Factory supports common programmable logic controllers (PLCs) from various manufacturers, such as Siemens, Beckhoff, Rockwell Automation and B&R. More information on the FBF can be found <a _blank"="" href="https://fbf.cloud.sick.com target=">here. Note: You can configure your function block at <a _blank"="" href="https://fbf.cloud.sick.com target=">Function Block Factory. As a login please use your SICK ID. 	Function Block Factory	On request

SICK AT A GLANCE

SICK is one of the leading manufacturers of intelligent sensors and sensor solutions for industrial applications. A unique range of products and services creates the perfect basis for controlling processes securely and efficiently, protecting individuals from accidents and preventing damage to the environment.

We have extensive experience in a wide range of industries and understand their processes and requirements. With intelligent sensors, we can deliver exactly what our customers need. In application centers in Europe, Asia and North America, system solutions are tested and optimized in accordance with customer specifications. All this makes us a reliable supplier and development partner.

Comprehensive services complete our offering: SICK LifeTime Services provide support throughout the machine life cycle and ensure safety and productivity.

For us, that is “Sensor Intelligence.”

WORLDWIDE PRESENCE:

Contacts and other locations –www.sick.com