



# RAY26P-P01

RAY26 Reflex Array

MULTITASK PHOTOELECTRIC SENSORS

**SICK**  
Sensor Intelligence.



Illustration may differ

### Ordering information

Type	Part no.
RAY26P-P01	1109011

**Included in delivery:** BEF-AP-PL4080 (1), BEF-SG-W1626 (1), RAY26P-24162330A00 (1), YF2Z14-100XXXLEAX (1), PL80A (1)

Other models and accessories → [www.sick.com/RAY26\\_Reflex\\_Array](http://www.sick.com/RAY26_Reflex_Array)



### Detailed technical data

#### Features

<b>Functional principle</b>	Photoelectric retro-reflective sensor
<b>Functional principle detail</b>	Without reflector minimum distance (autocollimation/coaxial optics), Reflex Array
<b>Dimensions (W x H x D)</b>	24.6 mm x 82.5 mm x 53.3 mm
<b>Housing design (light emission)</b>	Rectangular
<b>Minimum object size</b>	3 mm, position-independent detection within the light array (factory setting), adjustable via IO-Link incl. adjustable conveyor belt suppression 5 mm, position-independent detection within the light array, adjustable via IO-Link incl. adjustable conveyor belt suppression 10 mm, position-independent detection within the light array, adjustable via IO-Link incl. adjustable conveyor belt suppression
<b>Detection height</b>	55 mm
<b>Sensing range max.</b>	0 m ... 2 m <sup>1) 2)</sup> 0 m ... 3 m <sup>1) 3)</sup> 0 m ... 4.5 m <sup>1) 4)</sup>
<b>Distance of the sensor to reflector</b>	≥ 0 m
<b>Type of light</b>	Visible red light
<b>Light source</b>	PinPoint LED <sup>5)</sup>
<b>Light spot size (distance)</b>	55 mm x 9 mm (1 m)

<sup>1)</sup> Reflector PL80A.

<sup>2)</sup> At minimum object size 3 mm.

<sup>3)</sup> At minimum object size 5 mm.

<sup>4)</sup> At minimum object size 10 mm.

<sup>5)</sup> Average service life: 100,000 h at T<sub>J</sub> = +25 °C.

<b>Wave length</b>	635 nm
<b>Adjustment</b>	BluePilot: Teach-in, IO-Link
<b>Pin 2 configuration</b>	External Input (test), Teach-in, switching signal
<b>AutoAdapt</b>	✓
<b>Special applications</b>	Detecting objects with position tolerances, Detecting perforated objects, Detecting uneven, shiny objects, Detecting transparent objects, Detecting flat objects
<b>Special features</b>	1 x RAY26 1221060, with cable 6027559, mounting bracket 2123991 with screws and washers, PL80A 1003865, premounted on mounting bracket 2123993, 4 x screws, slot nuts for attachment to ITEM profile

1) Reflector PL80A.

2) At minimum object size 3 mm.

3) At minimum object size 5 mm.

4) At minimum object size 10 mm.

5) Average service life: 100,000 h at  $T_U = +25 \text{ }^\circ\text{C}$ .

## Mechanics/electronics

<b>Supply voltage <math>U_B</math></b>	10 V DC ... 30 V DC <sup>1)</sup>
<b>Ripple</b>	< 5 V <sub>pp</sub>
<b>Current consumption</b>	25 mA, 40 mA <sup>2) 3)</sup>
<b>Switching output</b>	Push-pull: PNP/NPN <sup>4)</sup>
<b>Output: <math>Q_{L1}</math> / C</b>	Switching output or IO-Link mode
<b>Output function</b>	Factory setting: Pin 2 / white (MF): NPN normally closed (light switching), PNP normally open (dark switching), Pin 4 / black ( $Q_{L1}$ / C): NPN normally open (dark switching), PNP normally closed (light switching), IO-Link
<b>Switching mode</b>	Light/dark switching
<b>Switching mode selector</b>	Via IO-Link
<b>Signal voltage PNP HIGH/LOW</b>	Approx. $V_S - 2.5 \text{ V} / 0 \text{ V}$
<b>Signal voltage NPN HIGH/LOW</b>	Approx. $V_S / < 2.5 \text{ V}$
<b>Output current <math>I_{max}</math></b>	≤ 100 mA
<b>Response time</b>	≤ 3 ms <sup>5)</sup>
<b>Switching frequency</b>	170 Hz <sup>6)</sup>
<b>Connection type</b>	Male connector M12, 4-pin
<b>Circuit protection</b>	A <sup>7)</sup> B <sup>8)</sup> C <sup>9)</sup> D <sup>10)</sup>

1) Limit values.

2) 16 V DC ... 30 V DC, without load.

3) 10 V DC ... 16 V DC, without load.

4) Pin 4 and pin 2: This switching output must not be connected to another output.

5) Signal transit time with resistive load in switching mode. Different values possible in COM2 mode.

6) With light/dark ratio 1:1 in switching mode. Different values possible in IO-Link mode.

7) A =  $V_S$  connections reverse-polarity protected.

8) B = inputs and output reverse-polarity protected.

9) C = interference suppression.

10) D = outputs overcurrent and short-circuit protected.

11) Avoid condensation on the front screen of the sensor and on the reflector.

12) Allowed temperature change after Teach +/- 20 K.

<b>Protection class</b>	III
<b>Weight</b>	80 g
<b>Housing material</b>	Plastic, VISTAL®
<b>Optics material</b>	Plastic, PMMA
<b>Enclosure rating</b>	IP66 IP67
<b>Ambient operating temperature</b>	-40 °C ... +60 °C <sup>11)</sup> <sup>12)</sup>
<b>Ambient temperature, storage</b>	-40 °C ... +75 °C
<b>UL File No.</b>	NRKH.E181493 & NRKH7.E181493

<sup>1)</sup> Limit values.

<sup>2)</sup> 16 V DC ... 30 V DC, without load.

<sup>3)</sup> 10 V DC ... 16 V DC, without load.

<sup>4)</sup> Pin 4 and pin 2: This switching output must not be connected to another output.

<sup>5)</sup> Signal transit time with resistive load in switching mode. Different values possible in COM2 mode.

<sup>6)</sup> With light/dark ratio 1:1 in switching mode. Different values possible in IO-Link mode.

<sup>7)</sup> A = V<sub>S</sub> connections reverse-polarity protected.

<sup>8)</sup> B = inputs and output reverse-polarity protected.

<sup>9)</sup> C = interference suppression.

<sup>10)</sup> D = outputs overcurrent and short-circuit protected.

<sup>11)</sup> Avoid condensation on the front screen of the sensor and on the reflector.

<sup>12)</sup> Allowed temperature change after Teach +/- 20 K.

### Safety-related parameters

<b>MTTF<sub>D</sub></b>	709 years
<b>DC<sub>avg</sub></b>	0 %

### Communication interface

<b>Communication interface</b>	IO-Link V1.1
<b>Communication Interface detail</b>	COM2 (38,4 kBaud)
<b>Cycle time</b>	2.3 ms
<b>Process data length</b>	16 Bit
<b>Process data structure</b>	Bit 0 = switching signal Q <sub>L1</sub> Bit 1 = switching signal Q <sub>L2</sub> Bit 2 ... 15 = empty
<b>VendorID</b>	26
<b>DeviceID HEX</b>	0x800217
<b>DeviceID DEC</b>	8389143

### Smart Task

<b>Smart Task name</b>	Base logics
<b>Logic function</b>	Direct AND OR Window Hysteresis
<b>Timer function</b>	Deactivated Switch-on delay

<sup>1)</sup> SIO Direct: sensor operation in standard I/O mode without IO-Link communication and without using internal sensor logic or time parameters (set to "direct"/"deactivated").

<sup>2)</sup> SIO Logic: Sensor operation in standard I/O mode without IO-Link communication. Sensor-internal logic or timing parameters plus Automation Functions used.

<sup>3)</sup> IOL: Sensor operation with full IO-Link communication and usage of logic, timing and Automation Function parameters.

	Off delay ON and OFF delay Impulse (one shot)
<b>Inverter</b>	Yes
<b>Switching frequency</b>	SIO Direct: 170 Hz <sup>1)</sup> SIO Logic: 170 Hz <sup>2)</sup> IOL: 170 Hz <sup>3)</sup>
<b>Response time</b>	SIO Direct: 3 ms <sup>1)</sup> SIO Logic: 3 ms <sup>2)</sup> IOL: 3 ms <sup>3)</sup>
<b>Repeatability</b>	SIO Direct: 1,5 ms <sup>1)</sup> SIO Logic: 1,5 ms <sup>2)</sup> IOL: 1,5 ms <sup>3)</sup>
<b>Switching signal</b>	
Switching signal Q <sub>L1</sub>	Switching output
Switching signal Q <sub>L2</sub>	Switching output

<sup>1)</sup> SIO Direct: sensor operation in standard I/O mode without IO-Link communication and without using internal sensor logic or time parameters (set to "direct"/"deactivated").

<sup>2)</sup> SIO Logic: Sensor operation in standard I/O mode without IO-Link communication. Sensor-internal logic or timing parameters plus Automation Functions used.

<sup>3)</sup> IOL: Sensor operation with full IO-Link communication and usage of logic, timing and Automation Function parameters.

### Diagnosis

<b>Device status</b>	Yes
----------------------	-----

### Classifications

<b>ECLASS 5.0</b>	27270902
<b>ECLASS 5.1.4</b>	27270902
<b>ECLASS 6.0</b>	27270902
<b>ECLASS 6.2</b>	27270902
<b>ECLASS 7.0</b>	27270902
<b>ECLASS 8.0</b>	27270902
<b>ECLASS 8.1</b>	27270902
<b>ECLASS 9.0</b>	27270902
<b>ECLASS 10.0</b>	27270902
<b>ECLASS 11.0</b>	27270902
<b>ECLASS 12.0</b>	27270902
<b>ETIM 5.0</b>	EC002717
<b>ETIM 6.0</b>	EC002717
<b>ETIM 7.0</b>	EC002717
<b>ETIM 8.0</b>	EC002717
<b>UNSPSC 16.0901</b>	39121528

Connection diagram

Cd-390

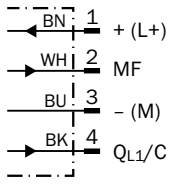

Light spot size

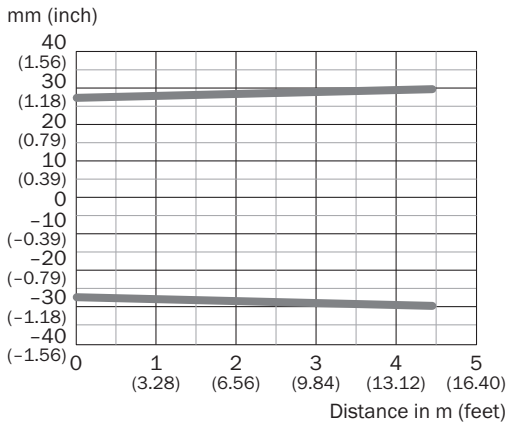

Sensing range diagram

Sensing range diagram (MDO 3 mm)

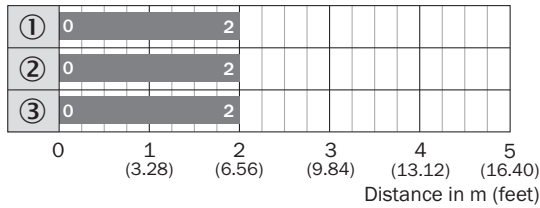

- Sensing range
- ① Reflector PL80A
- ② Reflector PL81
- ③ Reflector PL100

Sensing range diagram (MDO 10 mm)

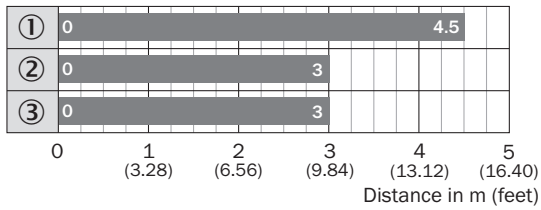

- Sensing range
- ① Reflector PL80A
- ② Reflector PL81
- ③ Reflector PL100

Sensing range diagram (MDO 5 mm)

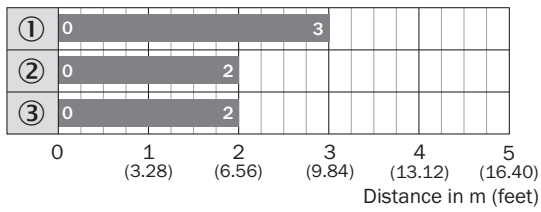

- Sensing range
- ① Reflector PL80A
- ② Reflector PL81
- ③ Reflector PL100

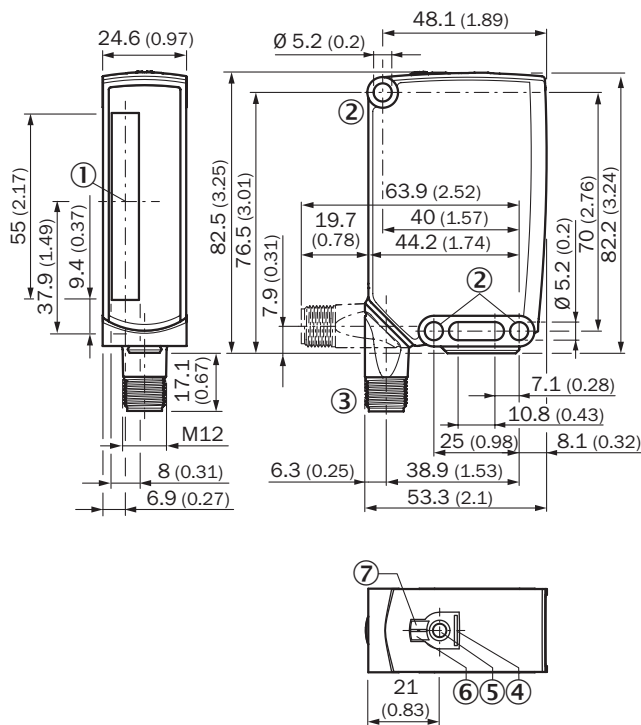

### Dimensional drawing (Dimensions in mm (inch))



- ① Center of optical axis
- ② Mounting hole,  $\varnothing$  5.2 mm
- ③ Connection
- ④ BluePilot blue: AutoAdapt indicator during run mode
- ⑤ Teach-in button
- ⑥ LED indicator yellow: Status of received light beam
- ⑦ LED indicator green: Supply voltage active

### Recommended accessories

Other models and accessories → [www.sick.com/RAY26\\_Reflex\\_Array](http://www.sick.com/RAY26_Reflex_Array)

	Brief description	Type	Part no.
<b>Mounting brackets and plates</b>			
	Mounting bracket, steel, zinc coated, mounting hardware included	BEF-WN-W23	2019085
<b>Reflectors</b>			
	Rectangular, screw connection, 84 mm x 84 mm, PMMA/ABS, Screw-on, 2 hole mounting	PL80A	1003865
<b>Others</b>			
	<ul style="list-style-type: none"> <li>• <b>Connection type head A:</b> Male connector, M12, 4-pin, straight, A-coded</li> <li>• <b>Description:</b> Unshielded</li> <li>• <b>Connection systems:</b> Screw-type terminals</li> <li>• <b>Permitted cross-section:</b> <math>\leq 0.75 \text{ mm}^2</math></li> </ul>	STE-1204-G	6009932



	Brief description	Type	Part no.
	<ul style="list-style-type: none"> <li>• <b>Connection type head A:</b> Female connector, M12, 4-pin, straight, A-coded</li> <li>• <b>Connection type head B:</b> Flying leads</li> <li>• <b>Signal type:</b> Sensor/actuator cable</li> <li>• <b>Cable:</b> 5 m, 4-wire, PVC</li> <li>• <b>Description:</b> Sensor/actuator cable, unshielded</li> <li>• <b>Application:</b> Zones with chemicals</li> </ul>	YF2A14-050VB3XLEAX	2096235

## SICK AT A GLANCE

SICK is one of the leading manufacturers of intelligent sensors and sensor solutions for industrial applications. A unique range of products and services creates the perfect basis for controlling processes securely and efficiently, protecting individuals from accidents and preventing damage to the environment.

We have extensive experience in a wide range of industries and understand their processes and requirements. With intelligent sensors, we can deliver exactly what our customers need. In application centers in Europe, Asia and North America, system solutions are tested and optimized in accordance with customer specifications. All this makes us a reliable supplier and development partner.

Comprehensive services complete our offering: SICK LifeTime Services provide support throughout the machine life cycle and ensure safety and productivity.

For us, that is “Sensor Intelligence.”

## WORLDWIDE PRESENCE:

Contacts and other locations –[www.sick.com](http://www.sick.com)