



# RFU610-10614

RFU61x

RFID

**SICK**  
Sensor Intelligence.



### Ordering information

Type	Part no.
RFU610-10614	1104441

**Included in delivery:** Mounting kit (1)

Other models and accessories → [www.sick.com/RFU61x](http://www.sick.com/RFU61x)



### Detailed technical data

#### Features

<b>Version</b>	Short Range
<b>Product category</b>	RFID read/write device with integrated antenna
<b>Radio approval</b>	Malaysia
<b>Frequency band</b>	UHF (860 MHz ... 960 MHz)
<b>Carrier frequency</b>	919.25 MHz ... 922.75 MHz
<b>Output power</b>	25 mW (ERP, 14 dBm)
<b>RFID standard</b>	EPCglobal UHF Class 1 Generation 2, ISO/IEC 18000-6 C, RAIN
<b>Modulation</b>	PR-ASK
<b>Connection type</b>	PoE, Power and Ethernet
<b>Aperture angle</b>	110°
<b>Read range</b>	≤ 0.5 m <sup>1)</sup>
<b>Antenna</b>	Integrated
Transmitting power	Adjustable
Polarization	Circular
Axial ratio	Typ. 3 dB
Front-to-back ratio	> 5 dB

<sup>1)</sup> Depending on transponder used and ambient conditions.

#### Mechanics/electronics

<b>Connection type</b>	1 x M12, 4-pin male connector, A-coded 1 x M12, 8-pin female connector, X-coded 1 x M8, 4-pin female connector, A-coded 1 x USB, 5-pin micro-B socket
<b>Supply voltage</b>	18 V DC ... 30 V DC <sup>1)</sup>
<b>Power consumption</b>	6 W, standby 3 W

<sup>1)</sup> PoE: 48 V DC ... 57 V DC in accordance with PoE technology.

<sup>2)</sup> Operation at +50 °C.

<b>Housing material</b>	Aluminum die cast Plastic (PPS)
<b>Enclosure rating</b>	IP67
<b>Protection class</b>	III
<b>Weight</b>	313 g
<b>Dimensions (L x W x H)</b>	92 mm x 80 mm x 38 mm
<b>MTBF</b>	22 years <sup>2)</sup>

<sup>1)</sup> PoE: 48 V DC ... 57 V DC in accordance with PoE technology.

<sup>2)</sup> Operation at +50 °C.

## Interfaces

<b>Ethernet</b>	✓, TCP/IP, PoE, OPC UA
Remark	Companion Spec V1.0 from firmware 2.20
Function	Data interface (read result output), Service interface
Data transmission rate	10/100 MBit/s
<b>PROFINET</b>	✓
Function	PROFINET Single Port, Data interface (read result output)
Data transmission rate	10/100 MBit/s
<b>EtherNet/IP™</b>	✓
Function	Data interface (read result output)
Data transmission rate	10/100 MBit/s
<b>USB</b>	✓
Remark	USB 2.0
Function	Service interface
<b>Digital inputs</b>	1 (physical, switching, trigger sensor can be connected directly to the device (port 3) - max. 40 mA)
<b>Optical indicators</b>	4 LEDs, multi-color (device status) 4 RGB LED (Process feedback)
<b>Operator interfaces</b>	Web server
<b>Configuration software</b>	SOPAS ET <sup>1)</sup>
<b>Programming interface</b>	Application-specific programming using the SICK AppStudio development environment
<b>Memory card</b>	microSD memory card (parameter cloning, data storage)

<sup>1)</sup> Another alternative is to generate your own configuration tools based on the SICK command language CoLa (e.g. in your own software or on PLC function blocks).

## Ambient data

<b>Electromagnetic compatibility (EMC)</b>	EN 301489-3
<b>Vibration resistance</b>	EN 60068-2-6:2007
<b>Shock resistance</b>	EN 60068-2-27:2008
<b>Ambient operating temperature</b>	-25 °C ... +50 °C
<b>Storage temperature</b>	-40 °C ... +70 °C
<b>Permissible relative humidity</b>	90 %, Non-condensing

## Classifications

<b>ECLASS 5.0</b>	27280401
<b>ECLASS 5.1.4</b>	27280401

<b>ECLASS 6.0</b>	27280401
<b>ECLASS 6.2</b>	27280401
<b>ECLASS 7.0</b>	27280401
<b>ECLASS 8.0</b>	27280401
<b>ECLASS 8.1</b>	27280401
<b>ECLASS 9.0</b>	27280401
<b>ECLASS 10.0</b>	27280401
<b>ECLASS 11.0</b>	27280401
<b>ECLASS 12.0</b>	27280401
<b>ETIM 6.0</b>	EC002998
<b>ETIM 7.0</b>	EC002998
<b>ETIM 8.0</b>	EC002998
<b>UNSPSC 16.0901</b>	52161523

## Dimensional drawing (Dimensions in mm (inch))

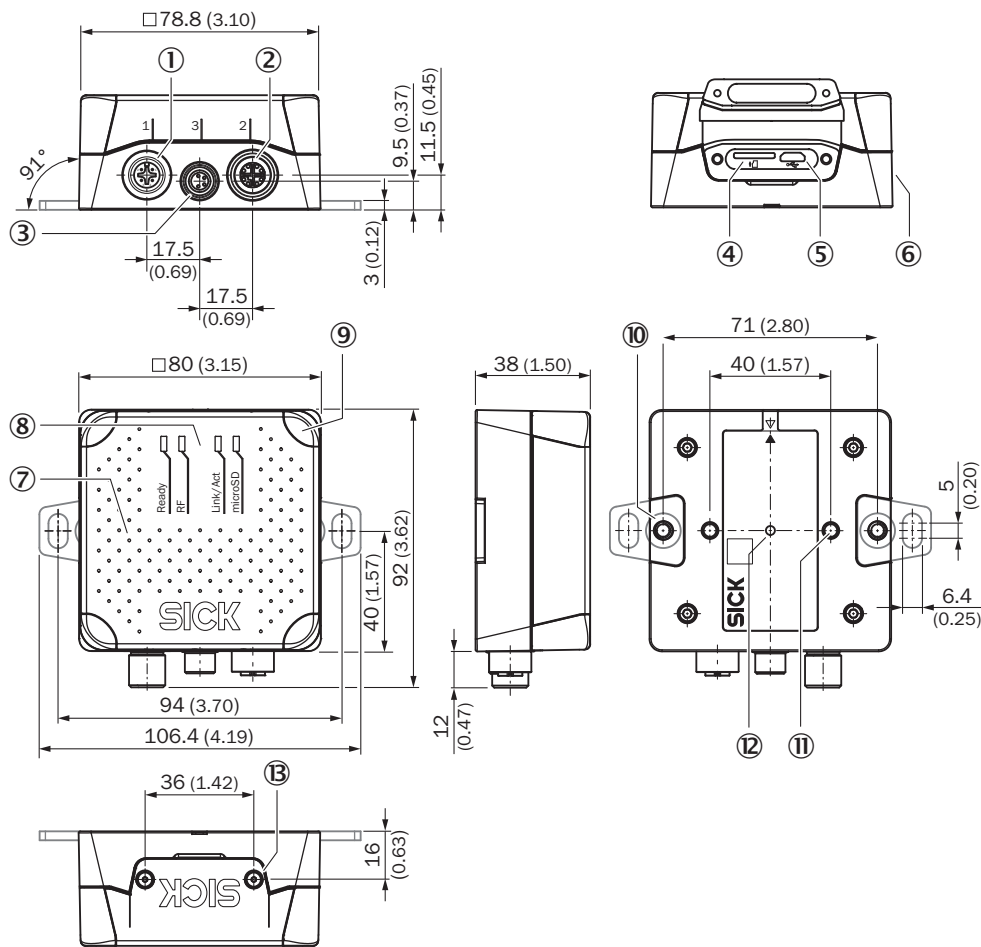

- ① Port 1: Power (male connector, M12, 4-pin, A-coded)
- ② Port 2: PoE (female connector, M12, 8-pin, X-coded)
- ③ Port 3: Trigger (female connector, M8, 4-pin, A-coded)
- ④ Slot for microSD memory card
- ⑤ "USB" connection (female connector, 5-pin, type Micro-B) interface for temporary use (service)
- ⑥ Side type label
- ⑦ Cover with integrated antenna
- ⑧ 4 x multi-colored LED (status)
- ⑨ 4 x RGB LED (process feedback)
- ⑩ 2 x M5 blind tapped holes, 6 mm deep for attaching the mounting straps
- ⑪ 2 x M5 blind tapped holes, 7 mm deep for mounting the device
- ⑫ Type label with integrated pressure compensation membrane
- ⑬ 2 x screw (M2,5 socket screw), captive, for side cover

### Radiation pattern

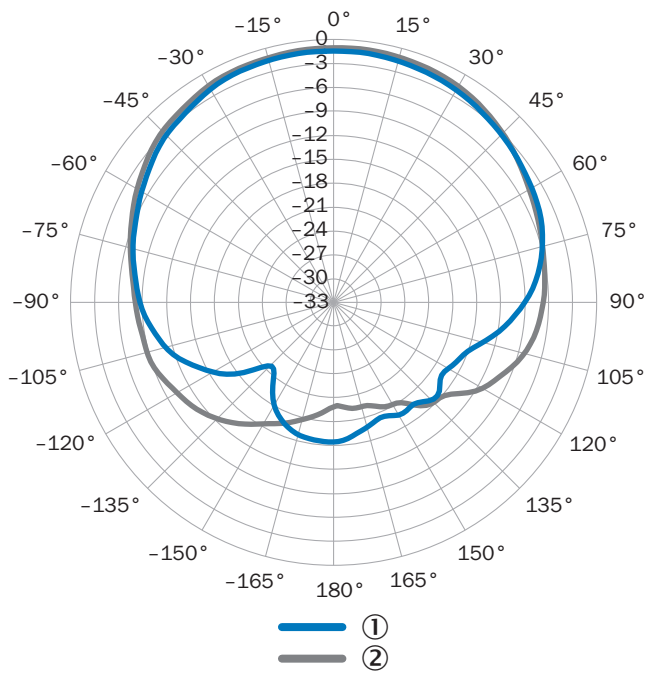

Measured antenna gain in dBic at 866.5 MHz, LHCP (left-hand circularly polarized)

- ① Horizontal plane (azimuth)
- ② Vertical plane (elevation)

### Connection diagram

PROFINET IO/RT

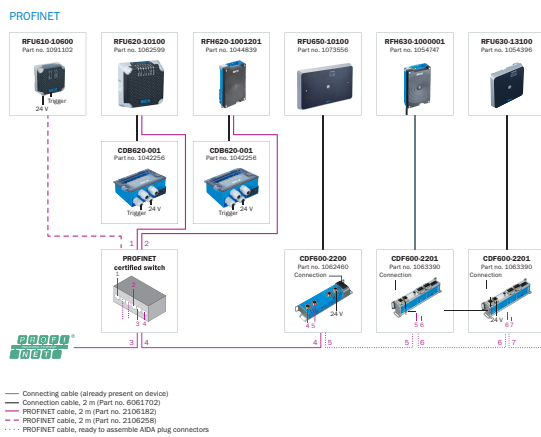

## System construction

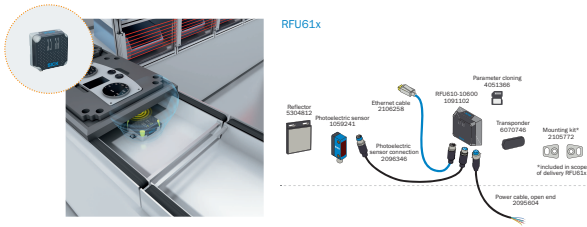

Monitoring of an assembly line, PCB production and pallet identification

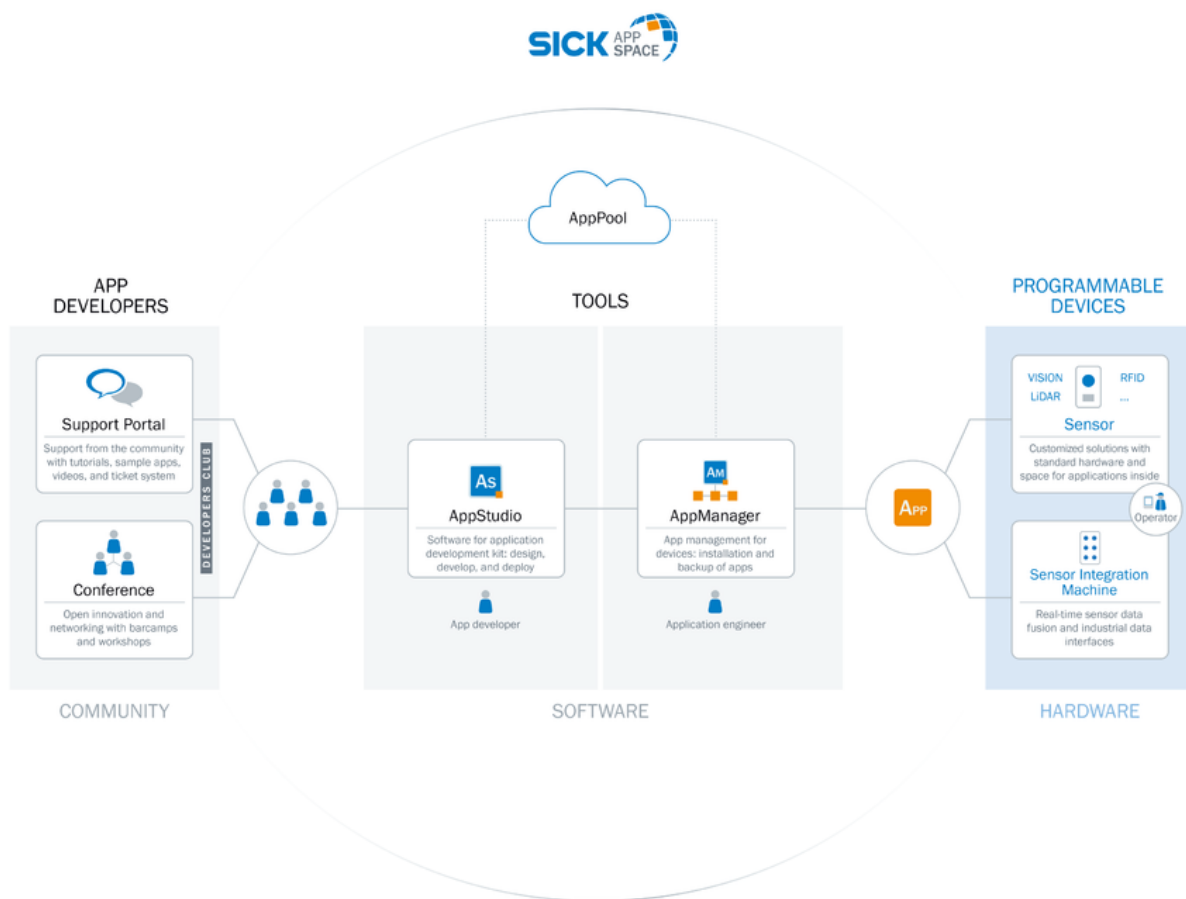

## Overview

SICK AppSpace



## Recommended accessories

Other models and accessories → [www.sick.com/RFU61x](http://www.sick.com/RFU61x)

	Brief description	Type	Part no.
Reflectors			
	Rectangular, screw connection, 51 mm x 61 mm, PMMA/ABS, Screw-on, 2 hole mounting	P250	5304812
Others			
	<ul style="list-style-type: none"> <li>• <b>Carrier frequency:</b> 865 MHz ... 928 MHz</li> <li>• <b>Memory capacity (UII / user memory):</b> 496/128 Bit</li> <li>• <b>Dimensions (L x W x H):</b> 15 mm x 97 mm x 0.2 mm</li> </ul>	UHF Transponder, paper label, global	6070051
	<ul style="list-style-type: none"> <li>• <b>Connection type head A:</b> Female connector, M12, 4-pin, straight, A-coded</li> <li>• <b>Connection type head B:</b> Flying leads</li> <li>• <b>Signal type:</b> Sensor/actuator cable</li> <li>• <b>Cable:</b> 2 m, 4-wire, PUR, halogen-free</li> <li>• <b>Description:</b> Sensor/actuator cable, unshielded</li> <li>• <b>Application:</b> Uncontaminated zones, Zones with oils and lubricants, Robot, Drag chain operation</li> </ul>	YF2A14-020UB3XLEAX	2095607
	<ul style="list-style-type: none"> <li>• <b>Connection type head A:</b> Male connector, M12, 8-pin, straight, X-coded</li> <li>• <b>Connection type head B:</b> Male connector, RJ45, 8-pin, straight</li> <li>• <b>Signal type:</b> Ethernet, Gigabit Ethernet</li> <li>• <b>Cable:</b> 2 m, 8-wire, PUR, halogen-free</li> <li>• <b>Description:</b> Ethernet, Gigabit Ethernet, shielded</li> <li>• <b>Application:</b> Zones with oils and lubricants</li> </ul>	YM2X18-020EG1MRJA8	2106258
	<ul style="list-style-type: none"> <li>• <b>Carrier frequency:</b> 865 MHz ... 928 MHz</li> <li>• <b>Memory capacity (UII / user memory):</b> 128/512 Bit</li> <li>• <b>Dimensions (L x W x H):</b> 18 mm x 122 mm x 2 mm</li> </ul>	UHF Transponder, rectangular, global	6068184
	<ul style="list-style-type: none"> <li>• <b>Carrier frequency:</b> 865 MHz ... 928 MHz</li> <li>• <b>Memory capacity (UII / user memory):</b> 496/128 Bit</li> <li>• <b>Dimensions (L x W x H):</b> 18 mm x 122 mm x 2 mm</li> </ul>	UHF Transponder, Rectangular, global	6088050
	<ul style="list-style-type: none"> <li>• <b>Connection type head A:</b> Male connector, M12, 8-pin, straight, X-coded</li> <li>• <b>Connection type head B:</b> Male connector, RJ45, 8-pin, straight</li> <li>• <b>Signal type:</b> Ethernet, Gigabit Ethernet</li> <li>• <b>Cable:</b> 3 m, 8-wire, PUR, halogen-free</li> <li>• <b>Description:</b> Ethernet, Gigabit Ethernet, shielded</li> <li>• <b>Application:</b> Zones with oils and lubricants</li> </ul>	YM2X18-030EG1MRJA8	2145693
Photoelectric sensors			
	<ul style="list-style-type: none"> <li>• <b>Sensing range max.:</b> 0.03 m ... 6 m</li> <li>• <b>Functional principle:</b> Photoelectric retro-reflective sensor</li> <li>• <b>Connection type:</b> Male connector M8, 4-pin</li> <li>• <b>Type of light:</b> Visible red light</li> <li>• <b>Adjustment:</b> Potentiometer</li> <li>• <b>Housing:</b> Rectangular</li> </ul>	GL6-P4211	1059241



## Recommended services

Additional services → [www.sick.com/RFU61x](http://www.sick.com/RFU61x)

	Type	Part no.
Commissioning		
<ul style="list-style-type: none"> <li>• <b>Product area:</b> RFID</li> <li>• <b>Range of services:</b> Inspection of connection, alignment, optimization of parameters of the RFU/RFH as well as tests, Setup of previously defined functions of reading configuration, data processing and network, interfaces and inputs and outputs</li> <li>• <b>Duration:</b> Additional work will be invoiced separately</li> </ul>	Commissioning RFU/RFH	1610018
Maintenance		
<ul style="list-style-type: none"> <li>• <b>Product area:</b> RFID</li> <li>• <b>Range of services:</b> Inspection, analysis and restoring of defined functions, Checking and adjustment of reading configuration, data processing, network, interfaces and inputs and outputs as well as operating data</li> <li>• <b>Duration:</b> Additional work will be invoiced separately</li> </ul>	Maintenance RFU/RFH	1611424
Extended warranty		
<ul style="list-style-type: none"> <li>• <b>Product area:</b> Machine vision, LiDAR sensors, safety camera sensors, Safety laser scanners, Safety radar sensors, Radar sensors, Fixed mount barcode scanners, Image-based code readers, RFID, Mobile handheld scanners</li> <li>• <b>Range of services:</b> The services correspond to the scope of the statutory warranty (SICK General Terms of Delivery)</li> <li>• <b>Duration:</b> Five-year warranty from delivery date.</li> </ul>	Extended warranty for a total of five years from delivery date	1680671

## SICK AT A GLANCE

SICK is one of the leading manufacturers of intelligent sensors and sensor solutions for industrial applications. A unique range of products and services creates the perfect basis for controlling processes securely and efficiently, protecting individuals from accidents and preventing damage to the environment.

We have extensive experience in a wide range of industries and understand their processes and requirements. With intelligent sensors, we can deliver exactly what our customers need. In application centers in Europe, Asia and North America, system solutions are tested and optimized in accordance with customer specifications. All this makes us a reliable supplier and development partner.

Comprehensive services complete our offering: SICK LifeTime Services provide support throughout the machine life cycle and ensure safety and productivity.

For us, that is “Sensor Intelligence.”

## WORLDWIDE PRESENCE:

Contacts and other locations –[www.sick.com](http://www.sick.com)