



RFU610-10713

RFU61x

RFID

SICK
Sensor Intelligence.



Ordering information

Type	Part no.
RFU610-10713	1135693

Included in delivery: Mounting kit (1)

Other models and accessories → www.sick.com/RFU61x



Detailed technical data

Features

Version	Short Range
Product category	RFID read/write device with integrated antenna
Radio approval	Taiwan
Frequency band	UHF (860 MHz ... 960 MHz)
Carrier frequency	922.25 MHz ... 927.75 MHz
Output power	40 mW (ERP, 16 dBm)
RFID standard	EPCglobal UHF Class 1 Generation 2, ISO/IEC 18000-6 C, RAIN
Modulation	PR-ASK
Connection type	IO-Link
Aperture angle	110°
Read range	≤ 0.5 m ¹⁾
Antenna	Integrated
Transmitting power	Adjustable
Polarization	Circular
Axial ratio	Typ. 2 dB
Front-to-back ratio	> 5 dB

¹⁾ Depending on transponder used and ambient conditions.

Mechanics/electronics

Connection type	1 x M12, 4-pin male connector, A-coded 1 x M8, 4-pin socket 1 x USB, 5-pin micro-B socket
Supply voltage	18 V DC ... 30 V DC

¹⁾ Operation at +50 °C.

Power consumption	6 W, standby 3 W
Housing material	Aluminum die cast Plastic (PPS)
Enclosure rating	IP67
Protection class	III
Weight	313 g
Dimensions (L x W x H)	92 mm x 80 mm x 38 mm
MTBF	22.25 years ¹⁾

¹⁾ Operation at +50 °C.

Interfaces

IO-Link	✓, IO-Link V1.1
Remark	Process data length: IN (input), 32 bytes; OUT (output), 32 bytes, SIO mode not supported
Function	Process data, parameterization, diagnosis
Data transmission rate	COM3 (230,4 kBaud)
Digital inputs	1 (physical, switching, trigger sensor can be connected directly to the device (port 3))
Digital outputs	1 (Q ₂ , Switching, PNP, in IO-Link mode)
Optical indicators	4 LEDs, multi-color (device status) 4 RGB LED (Process feedback)
Configuration software	PLC software SOPAS ET ¹⁾
Memory card	Micro SD memory card

¹⁾ In combination with SiLink2 Master or SIG200.

Ambient data

Electromagnetic compatibility (EMC)	EN 301489-1 V2.1.1 (2017) / EN 301489-3 V1.6.1 (2013)
Vibration resistance	IEC 60068-2-6:2007 IEC 60068-2-64:2008
Shock resistance	EN 60068-2-27:2008
Ambient operating temperature	-25 °C ... +50 °C
Storage temperature	-40 °C ... +70 °C
Permissible relative humidity	90 %, Non-condensing

Classifications

ECLASS 5.0	27280401
ECLASS 5.1.4	27280401
ECLASS 6.0	27280401
ECLASS 6.2	27280401
ECLASS 7.0	27280401
ECLASS 8.0	27280401
ECLASS 8.1	27280401
ECLASS 9.0	27280401
ECLASS 10.0	27280401
ECLASS 11.0	27280401
ECLASS 12.0	27280401

ETIM 6.0	EC002998
ETIM 7.0	EC002998
ETIM 8.0	EC002998
UNSPSC 16.0901	52161523

Dimensional drawing (Dimensions in mm (inch))

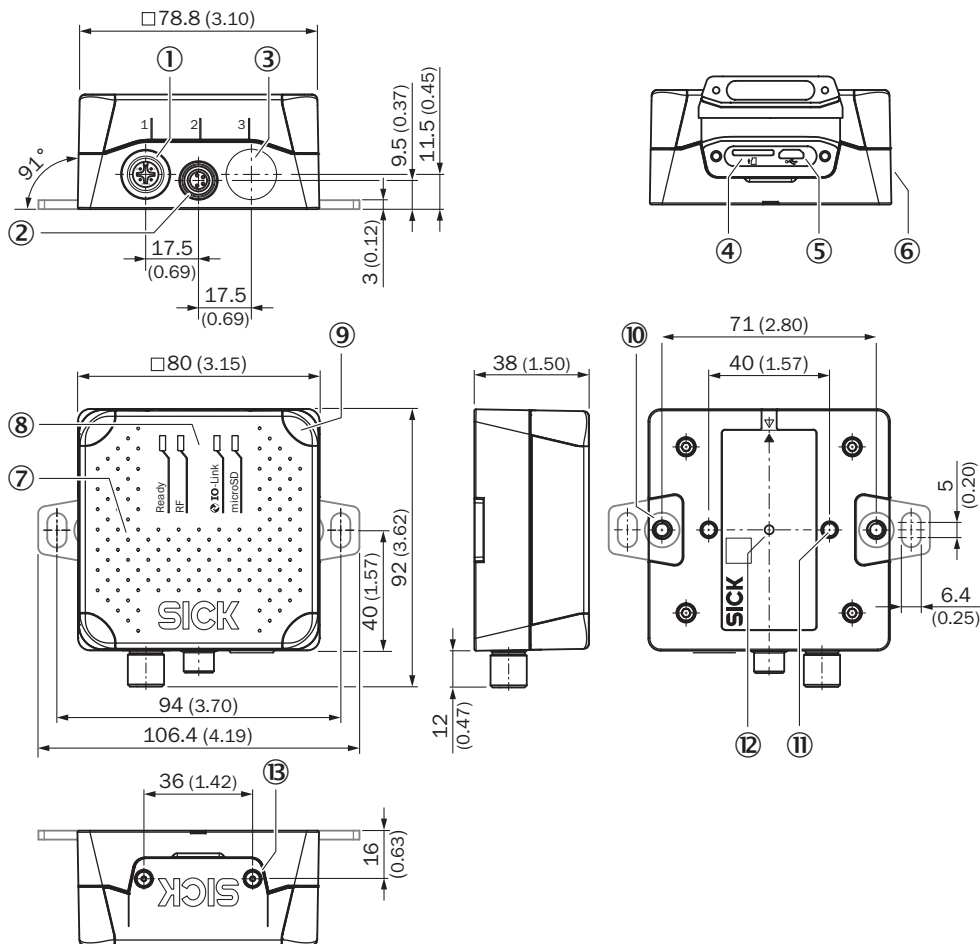

- ① Connection 1: IO-Link (male connector, M12, 4-pin, A-coded)
- ② Connection 2: Trigger (female connector, M8, 4-pin, coded)
- ③ Dummy plug
- ④ Slot for microSD memory card
- ⑤ "USB" connection (female connector, 5-pin, type Micro-B) interface for temporary use (service)
- ⑥ Side type label
- ⑦ Cover with integrated antenna
- ⑧ 4 x multi-colored LED (status)
- ⑨ 4 x multi-colored LED (process feedback)
- ⑩ 2 x M5 blind tapped holes, 6 mm deep for attaching the mounting straps
- ⑪ 2 x M5 blind tapped holes, 7 mm deep for mounting the device
- ⑫ Type label with integrated pressure compensation membrane
- ⑬ 2 x screw (M2,5 socket screw), captive, for side cover

Radiation pattern

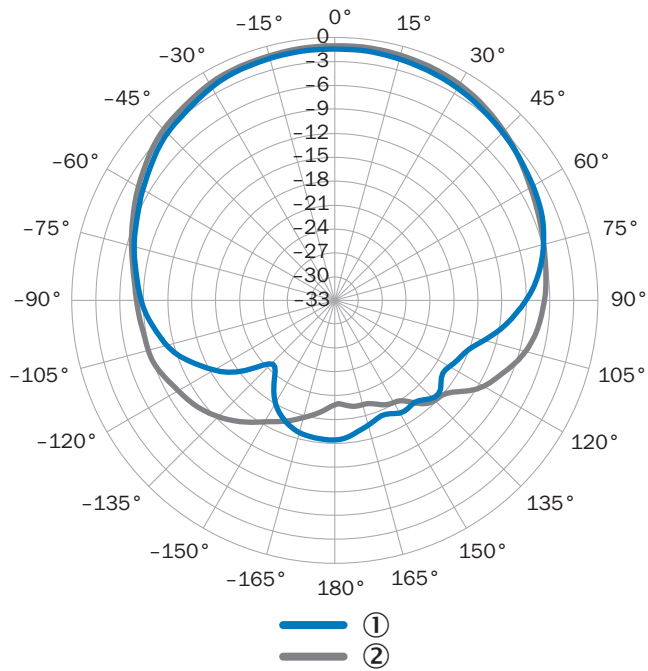

Measured antenna gain in dBic at 866.5 MHz, LHCP (left-hand circularly polarized)

- ① Horizontal plane (azimuth)
- ② Vertical plane (elevation)

PIN assignment

IO-Link connection

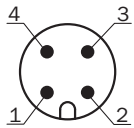





IO-Link connection (male connector, M12, 4-pin, A-coded)

- ① L+
- ② Reserved
- ③ L-
- ④ C/Q1

Recommended accessories

Other models and accessories → www.sick.com/RFU61x

	Brief description	Type	Part no.
Reflectors			
	Rectangular, screw connection, 51 mm x 61 mm, PMMA/ABS, Screw-on, 2 hole mounting	P250	5304812

	Brief description	Type	Part no.
Others			
	<ul style="list-style-type: none"> Carrier frequency: 865 MHz ... 928 MHz Memory capacity (UII / user memory): 496/128 Bit Dimensions (L x W x H): 15 mm x 97 mm x 0.2 mm 	UHF Transponder, paper label, global	6070051
	<ul style="list-style-type: none"> Connection type head A: Female connector, M12, 4-pin, straight, A-coded Connection type head B: Male connector, M12, 4-pin, straight, A-coded Signal type: Sensor/actuator cable Cable: 0.6 m, 4-wire, PUR, halogen-free Description: Sensor/actuator cable, unshielded Application: Uncontaminated zones, Zones with oils and lubricants, Robot, Drag chain operation 	YF2A14-C60UB3M2A14	2095999
Photoelectric sensors			
	<ul style="list-style-type: none"> Sensing range max.: 0.03 m ... 6 m Functional principle: Photoelectric retro-reflective sensor Connection type: Male connector M8, 4-pin Type of light: Visible red light Adjustment: Potentiometer Housing: Rectangular 	GL6-P4211	1059241
Sensor Integration Gateway			
	<ul style="list-style-type: none"> Further functions: Web server integrated, USB connection for easy configuration of the SIG200 Sensor Integration Gateway with SOPAS ET, the engineering tool from SICK, logic editor is available for easy configuration of logic functions Connection CONFIG: 1 x M8, 4-pin female connector, USB 2.0 (USB-A) Logic editor: yes Communication interface: IO-Link, USB, Ethernet, PROFINET, REST API Product category: IO-Link Master 	SIG200-0A0412200	1089794

Recommended services

Additional services → www.sick.com/RFU61x

	Type	Part no.
Commissioning		
<ul style="list-style-type: none"> Product area: RFID Range of services: Inspection of connection, alignment, optimization of parameters of the RFU/RFH as well as tests, Setup of previously defined functions of reading configuration, data processing and network, interfaces and inputs and outputs Duration: Additional work will be invoiced separately 	Commissioning RFU/RFH	1610018
Maintenance		
<ul style="list-style-type: none"> Product area: RFID Range of services: Inspection, analysis and restoring of defined functions, Checking and adjustment of reading configuration, data processing, network, interfaces and inputs and outputs as well as operating data Duration: Additional work will be invoiced separately 	Maintenance RFU/RFH	1611424
Extended warranty		
<ul style="list-style-type: none"> Product area: Machine vision, LiDAR sensors, safety camera sensors, Safety laser scanners, Safety radar sensors, Radar sensors, Fixed mount barcode scanners, Image-based code readers, RFID, Mobile handheld scanners Range of services: The services correspond to the scope of the statutory warranty (SICK General Terms of Delivery) Duration: Five-year warranty from delivery date. 	Extended warranty for a total of five years from delivery date	1680671

SICK AT A GLANCE

SICK is one of the leading manufacturers of intelligent sensors and sensor solutions for industrial applications. A unique range of products and services creates the perfect basis for controlling processes securely and efficiently, protecting individuals from accidents and preventing damage to the environment.

We have extensive experience in a wide range of industries and understand their processes and requirements. With intelligent sensors, we can deliver exactly what our customers need. In application centers in Europe, Asia and North America, system solutions are tested and optimized in accordance with customer specifications. All this makes us a reliable supplier and development partner.

Comprehensive services complete our offering: SICK LifeTime Services provide support throughout the machine life cycle and ensure safety and productivity.

For us, that is “Sensor Intelligence.”

WORLDWIDE PRESENCE:

Contacts and other locations –www.sick.com