



# RFU620-10108

RFU62x

RFID

**SICK**  
Sensor Intelligence.



## Mechanics/electronics

<b>Connection type</b>	1 x M12, 17-pin male connector, A-coded 1 x M12, 4-pin female connector, D-coded 1 x USB, 5-pin micro-B socket
<b>Supply voltage</b>	10 V DC ... 30 V DC <sup>1)</sup>
<b>Power consumption</b>	Typ. 8 W, with heating typ. 16 W
<b>Housing material</b>	Aluminum die cast Plastic (PPS)
<b>Enclosure rating</b>	IP67
<b>Protection class</b>	III
<b>Weight</b>	780 g
<b>Dimensions (L x W x H)</b>	137 mm x 131 mm x 56 mm
<b>MTBF</b>	> 100 years

<sup>1)</sup> With heating 20 V DC ... 30 V DC.

## Interfaces

<b>Ethernet</b>	✓, TCP/IP, OPC UA
Remark	Companion Spec V1.0 from firmware 2.20
Function	Data interface (read result output), Service interface
Data transmission rate	10/100 MBit/s
<b>PROFINET</b>	✓
Function	PROFINET Single Port, PROFINET Dual Port (optional via external connection module CDF600-2), Data interface (read result output)
Data transmission rate	10/100 MBit/s
<b>EtherNet/IP™</b>	✓
Function	Data interface (read result output)
Data transmission rate	10/100 MBit/s
<b>Serial</b>	✓, RS-232, RS-422
Remark	RS-422 only via 4-wire
Function	Data interface (read result output), Service interface
Data transmission rate	0.3 kBaud ... 115.2 kBaud, AUX: 57.6 kBaud
<b>CAN</b>	✓
Remark	CSN (SICK CAN Sensor Network)
Function	Data interface (read result output)
<b>PROFIBUS DP</b>	✓
Type of fieldbus integration	Optional over external fieldbus module CDF600-2
Function	Data interface (read result output)
<b>CANopen</b>	✓
Function	Data interface (read result output)
<b>EtherCAT</b>	✓
Type of fieldbus integration	Optional over external fieldbus module
Function	Data interface (read result output)
<b>USB</b>	✓

<sup>1)</sup> Another alternative is to generate your own configuration tools based on the SICK command language CoLa (e.g. in your own software or on PLC function blocks).

	Remark	USB 2.0
	Function	Service interface
<b>Digital inputs</b>		2 (physical, 2 additional logical inputs via optional CMC600 parameter memory in CD-B620 / CDM420)
<b>Digital outputs</b>		2 (physical, 2 additional logical outputs via optional CMC600 parameter memory in CD-B620 / CDM420)
<b>Optical indicators</b>		7 LEDs, multi-color (device status) 4 RGB LED (Process feedback)
<b>Operator interfaces</b>		Web server
<b>Configuration software</b>		SOPAS ET <sup>1)</sup>
<b>Programming interface</b>		Application-specific programming using the SICK AppStudio development environment
<b>Memory card</b>		microSD memory card (parameter cloning, data storage)

<sup>1)</sup> Another alternative is to generate your own configuration tools based on the SICK command language CoLa (e.g. in your own software or on PLC function blocks).

### Ambient data

<b>Electromagnetic compatibility (EMC)</b>	EN 301489-3
<b>Vibration resistance</b>	EN 60068-2-64:2008-02
<b>Shock resistance</b>	EN 60068-2-27:2009-05
<b>Ambient operating temperature</b>	-40 °C ... +50 °C
<b>Storage temperature</b>	-40 °C ... +70 °C
<b>Permissible relative humidity</b>	90 %, Non-condensing

### Classifications

<b>ECLASS 5.0</b>	27280401
<b>ECLASS 5.1.4</b>	27280401
<b>ECLASS 6.0</b>	27280401
<b>ECLASS 6.2</b>	27280401
<b>ECLASS 7.0</b>	27280401
<b>ECLASS 8.0</b>	27280401
<b>ECLASS 8.1</b>	27280401
<b>ECLASS 9.0</b>	27280401
<b>ECLASS 10.0</b>	27280401
<b>ECLASS 11.0</b>	27280401
<b>ECLASS 12.0</b>	27280401
<b>ETIM 6.0</b>	EC002998
<b>ETIM 7.0</b>	EC002998
<b>ETIM 8.0</b>	EC002998
<b>UNSPSC 16.0901</b>	52161523

## Dimensional drawing (Dimensions in mm (inch))

## Dimensional drawing RFU62x

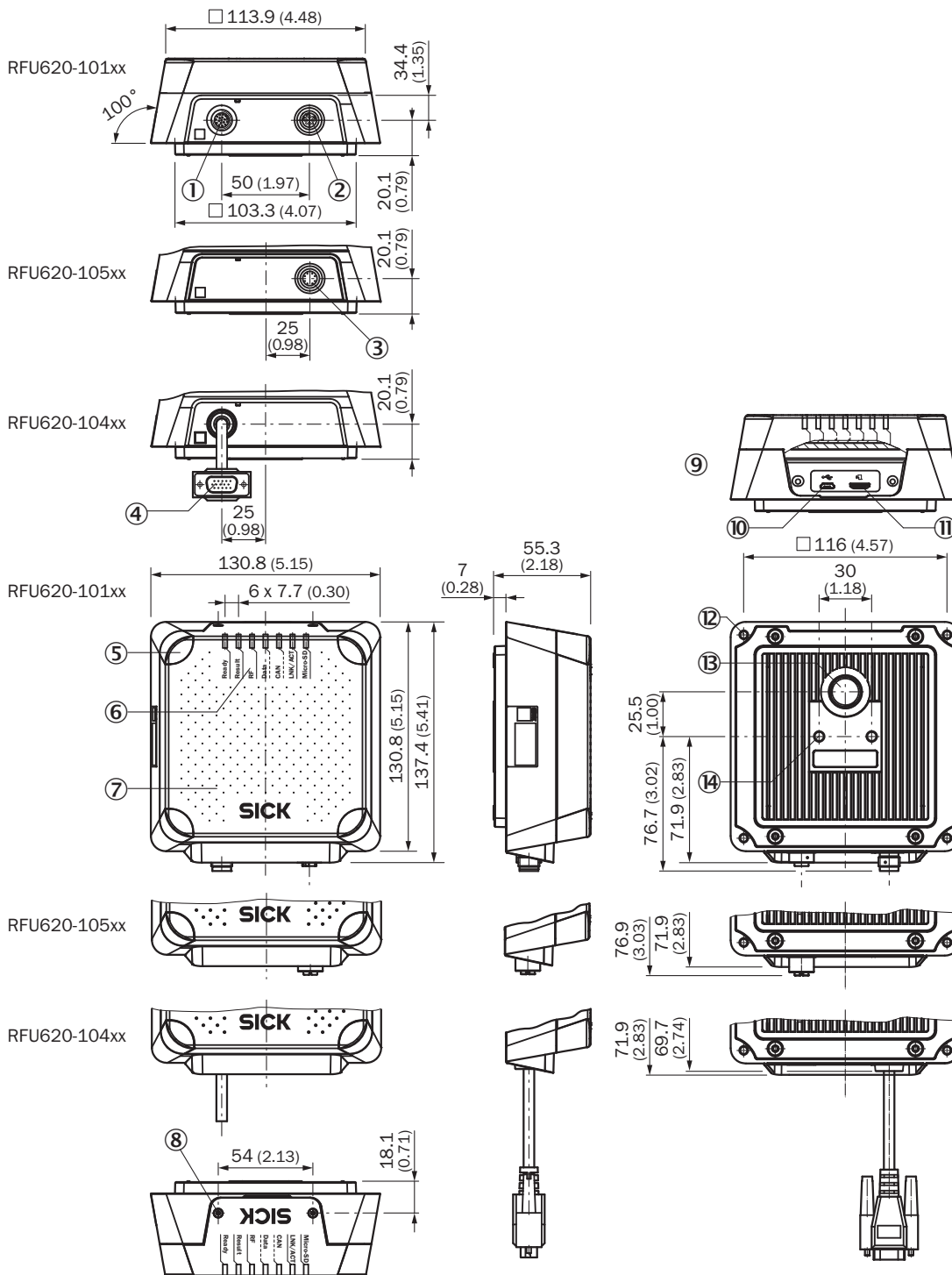

- ① "Power/AUX/CAN/I/O" connection, 17-pin M12 male connector, A-coded
- ② "Ethernet" connection, 4-pin M12 female connector, D-coded
- ③ "Ethernet" connection, 8-pin M12 female connector, X-coded
- ④ "Power/HOST/AUX/CAN/I/O" connection, 15-pin D-Sub HD male connector, cable 0,9 m
- ⑤ 4 x LED, multi-colored (process feedback)
- ⑥ 7 x LED for status display
- ⑦ Cover with integrated antenna
- ⑧ Screw (Torx T8), captive (2 x), for side cover
- ⑨ Side cover opened
- ⑩ USB socket, type Micro-B
- ⑪ Slot for microSD memory card
- ⑫ Blind hole thread M5, 9 mm deep (4 x), for alternatively mounting
- ⑬ Pressure compensation valve (ventilation element)
- ⑭ M6 blind tapped holes, 7 mm deep (2 x), for mounting

### Radiation pattern

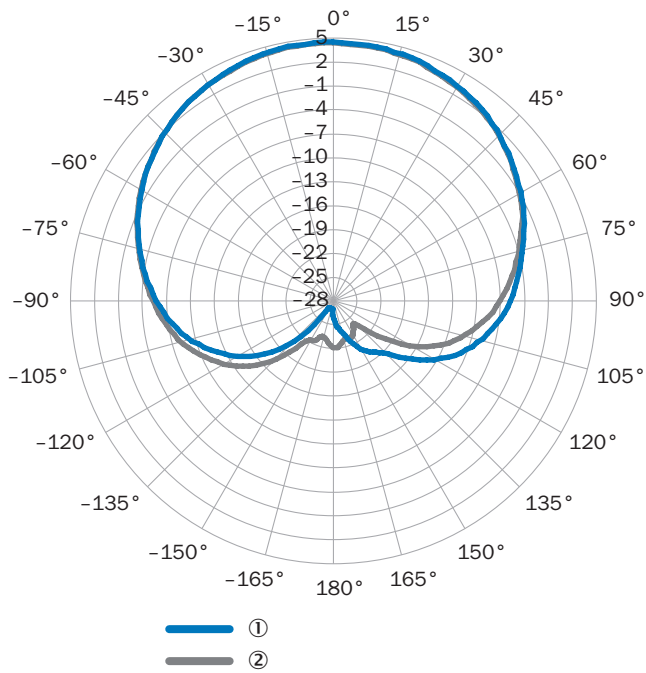

### Connection diagram

PROFINET IO/RT

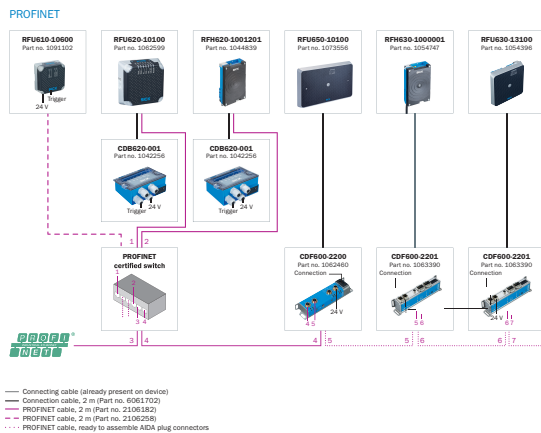

EtherCAT®

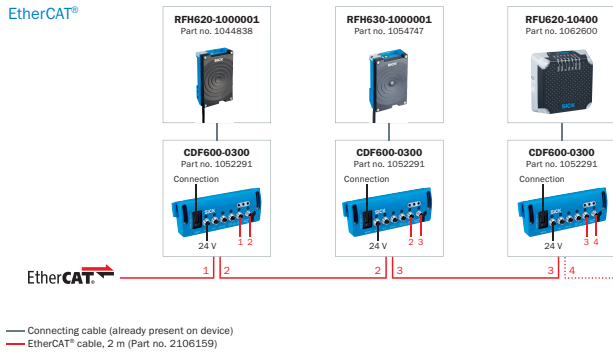

System construction

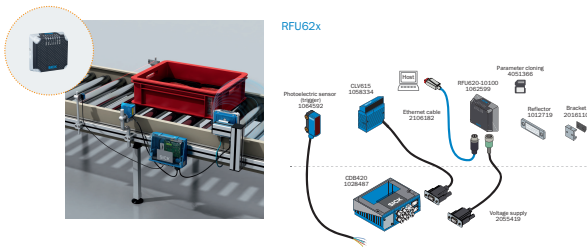

Data combination of barcode and RFID



### Overview

#### SICK AppSpace







### Recommended accessories

Other models and accessories → [www.sick.com/RFU62x](http://www.sick.com/RFU62x)

	Brief description	Type	Part no.
<b>Storage media</b>			
	microSD memory card with 1 GB for industrial use	microSD memory card	4051366
<b>Mounting brackets and plates</b>			
	Simple mounting bracket	Mounting bracket	2071067



	Brief description	Type	Part no.
Others			
	<ul style="list-style-type: none"> <li>• <b>Connection type head A:</b> Male connector, Micro-B, 4-pin, straight</li> <li>• <b>Connection type head B:</b> Male connector, USB-A, 4-pin, straight</li> <li>• <b>Signal type:</b> USB 2.0</li> <li>• <b>Cable:</b> 2 m, 4-wire</li> <li>• <b>Description:</b> USB 2.0, unshielded</li> </ul>	USB cable	6036106
	<ul style="list-style-type: none"> <li>• <b>Carrier frequency:</b> 865 MHz ... 928 MHz</li> <li>• <b>Memory capacity (UII / user memory):</b> 128/512 Bit</li> <li>• <b>Dimensions (L x W x H):</b> 18 mm x 122 mm x 2 mm</li> </ul>	UHF Transponder, rectangular, global	6068184
	<ul style="list-style-type: none"> <li>• <b>Carrier frequency:</b> 865 MHz ... 928 MHz</li> <li>• <b>Memory capacity (UII / user memory):</b> 496/128 Bit</li> <li>• <b>Dimensions (L x W x H):</b> 18 mm x 122 mm x 2 mm</li> </ul>	UHF Transponder, Rectangular, global	6088050
	<ul style="list-style-type: none"> <li>• <b>Connection type head A:</b> Male connector, M12, 4-pin, straight, D-coded</li> <li>• <b>Connection type head B:</b> Male connector, RJ45, 4-pin, straight</li> <li>• <b>Signal type:</b> Ethernet, PROFINET</li> <li>• <b>Cable:</b> 2 m, 4-wire, PUR, halogen-free</li> <li>• <b>Description:</b> Ethernet, PROFINET, shielded</li> <li>• <b>Application:</b> Drag chain operation, Zones with oils and lubricants</li> </ul>	YM2D24-020PN1MRJA4	2106182
Modules			
	<ul style="list-style-type: none"> <li>• <b>Sub product family:</b> CDB620</li> <li>• <b>Supported products:</b> CLV61x - CLV65x, Lector62x, RFH6xx, RFU62x</li> <li>• <b>Brief description:</b> Small connection module for one sensor, 4 cable glands, base for CMC600</li> </ul>	CDB620-001	1042256

## Recommended services

Additional services → [www.sick.com/RFU62x](http://www.sick.com/RFU62x)

	Type	Part no.
Commissioning		
<ul style="list-style-type: none"> <li>• <b>Product area:</b> RFID</li> <li>• <b>Range of services:</b> Inspection of connection, alignment, optimization of parameters of the RFU/RFH as well as tests, Setup of previously defined functions of reading configuration, data processing and network, interfaces and inputs and outputs</li> <li>• <b>Duration:</b> Additional work will be invoiced separately</li> </ul>	Commissioning RFU/RFH	1610018
Maintenance		
<ul style="list-style-type: none"> <li>• <b>Product area:</b> RFID</li> <li>• <b>Range of services:</b> Inspection, analysis and restoring of defined functions, Checking and adjustment of reading configuration, data processing, network, interfaces and inputs and outputs as well as operating data</li> <li>• <b>Duration:</b> Additional work will be invoiced separately</li> </ul>	Maintenance RFU/RFH	1611424
Extended warranty		
<ul style="list-style-type: none"> <li>• <b>Product area:</b> Machine vision, LiDAR sensors, safety camera sensors, Safety laser scanners, Safety radar sensors, Radar sensors, Fixed mount barcode scanners, Image-based code readers, RFID, Mobile handheld scanners</li> <li>• <b>Range of services:</b> The services correspond to the scope of the statutory manufacturer warranty (SICK general terms of delivery).</li> <li>• <b>Duration:</b> Five-year warranty from delivery date.</li> </ul>	Extended warranty for a total of five years from delivery date	1680671

## SICK AT A GLANCE

SICK is one of the leading manufacturers of intelligent sensors and sensor solutions for industrial applications. A unique range of products and services creates the perfect basis for controlling processes securely and efficiently, protecting individuals from accidents and preventing damage to the environment.

We have extensive experience in a wide range of industries and understand their processes and requirements. With intelligent sensors, we can deliver exactly what our customers need. In application centers in Europe, Asia and North America, system solutions are tested and optimized in accordance with customer specifications. All this makes us a reliable supplier and development partner.

Comprehensive services complete our offering: SICK LifeTime Services provide support throughout the machine life cycle and ensure safety and productivity.

For us, that is “Sensor Intelligence.”

## WORLDWIDE PRESENCE:

Contacts and other locations –[www.sick.com](http://www.sick.com)