



RFU620-10508

RFU62x

RFID

SICK
Sensor Intelligence.

Mechanics/electronics

Connection type	1, 1 x M12, 8-pin female connector, X-coded, USB, 5-pin micro-B socket
Supply voltage	48 V DC ... 57 V DC ¹⁾
Power consumption	Typ. 8 W, standby 3 W
Housing material	Aluminum die cast Plastic (PPS)
Enclosure rating	IP67
Protection class	III
Weight	780 g
Dimensions (L x W x H)	137 mm x 131 mm x 56 mm
MTBF	> 100 years

¹⁾ According to PoE technology.

Interfaces

Ethernet	✓, TCP/IP, PoE, OPC UA
Remark	Companion Spec V1.0 from firmware 2.20
Function	Data interface (read result output), Service interface, PoE
Data transmission rate	10/100 MBit/s
PROFINET	✓
Function	PROFINET Single Port, Data interface (read result output)
Data transmission rate	10/100 MBit/s
EtherNet/IP™	✓
Function	Data interface (read result output)
Data transmission rate	10/100 MBit/s
USB	✓
Remark	USB 2.0
Function	Service interface
Digital inputs	0
Digital outputs	0
Optical indicators	7 LEDs, multi-color (device status) 4 RGB LED (Process feedback)
Operator interfaces	Web server
Configuration software	SOPAS ET ¹⁾
Programming interface	Application-specific programming using the SICK AppStudio development environment
Memory card	microSD memory card (parameter cloning, data storage)

¹⁾ Another alternative is to generate your own configuration tools based on the SICK command language CoLa (e.g. in your own software or on PLC function blocks).

Ambient data

Electromagnetic compatibility (EMC)	EN 301489-3
Vibration resistance	EN 60068-2-64:2008-02
Shock resistance	EN 60068-2-27:2009-05
Ambient operating temperature	-25 °C ... +50 °C
Storage temperature	-40 °C ... +70 °C
Permissible relative humidity	90 %, Non-condensing

Classifications

ECLASS 5.0	27280401
ECLASS 5.1.4	27280401
ECLASS 6.0	27280401
ECLASS 6.2	27280401
ECLASS 7.0	27280401
ECLASS 8.0	27280401
ECLASS 8.1	27280401
ECLASS 9.0	27280401
ECLASS 10.0	27280401
ECLASS 11.0	27280401
ECLASS 12.0	27280401
ETIM 6.0	EC002998
ETIM 7.0	EC002998
ETIM 8.0	EC002998
UNSPSC 16.0901	52161523

Dimensional drawing (Dimensions in mm (inch))

Dimensional drawing RFU62x

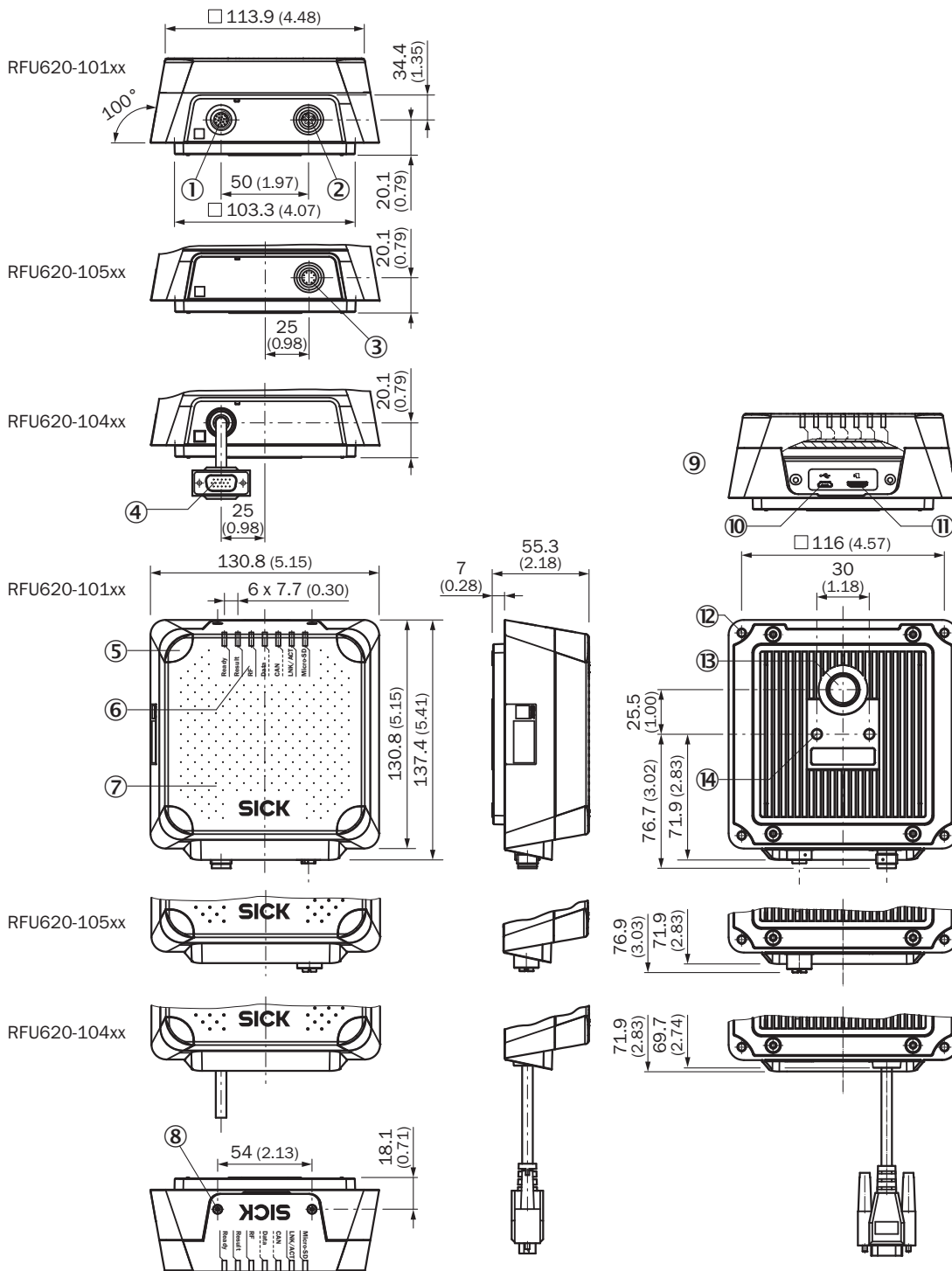

- ① "Power/AUX/CAN/I/O" connection, 17-pin M12 male connector, A-coded
- ② "Ethernet" connection, 4-pin M12 female connector, D-coded
- ③ "Ethernet" connection, 8-pin M12 female connector, X-coded
- ④ "Power/HOST/AUX/CAN/I/O" connection, 15-pin D-Sub HD male connector, cable 0,9 m
- ⑤ 4 x LED, multi-colored (process feedback)
- ⑥ 7 x LED for status display
- ⑦ Cover with integrated antenna
- ⑧ Screw (Torx T8), captive (2 x), for side cover
- ⑨ Side cover opened
- ⑩ USB socket, type Micro-B
- ⑪ Slot for microSD memory card
- ⑫ Blind hole thread M5, 9 mm deep (4 x), for alternatively mounting
- ⑬ Pressure compensation valve (ventilation element)
- ⑭ M6 blind tapped holes, 7 mm deep (2 x), for mounting

Radiation pattern



Measured antenna gain in dBic at 868.5 MHz, RHCP (right-hand circularly polarized)

① Horizontal plane (azimuth)

② Vertical plane (elevation)

Connection diagram

PROFINET IO/RT

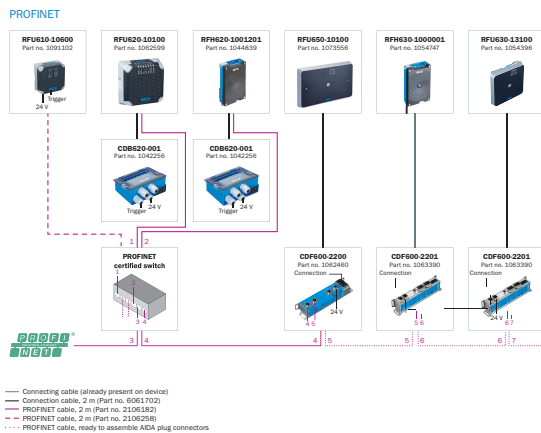

EtherCAT®



System construction

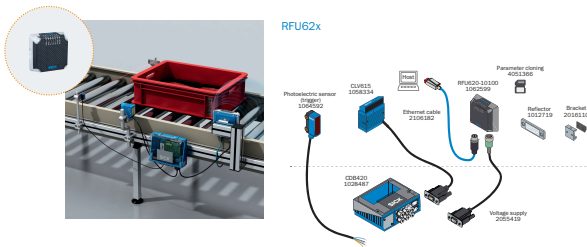

Data combination of barcode and RFID



Overview

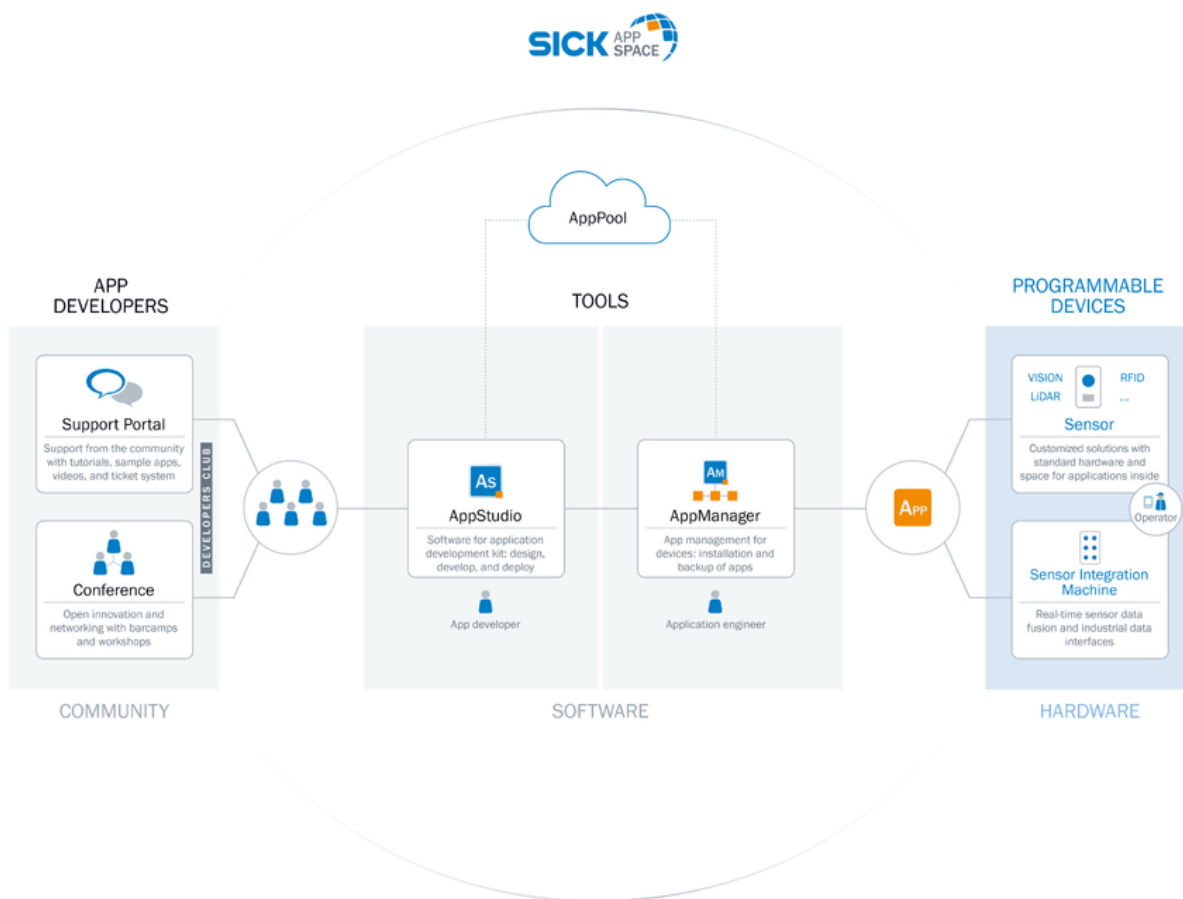

SICK AppSpace



Recommended accessories

Other models and accessories → www.sick.com/RFU62x

	Brief description	Type	Part no.
Storage media			
	microSD memory card with 1 GB for industrial use	microSD memory card	4051366
Mounting brackets and plates			
	Simple mounting bracket	Mounting bracket	2071067

	Brief description	Type	Part no.
Others			
	<ul style="list-style-type: none"> • Connection type head A: Male connector, Micro-B, 4-pin, straight • Connection type head B: Male connector, USB-A, 4-pin, straight • Signal type: USB 2.0 • Cable: 2 m, 4-wire • Description: USB 2.0, unshielded 	USB cable	6036106
	<ul style="list-style-type: none"> • Carrier frequency: 865 MHz ... 928 MHz • Memory capacity (Ull / user memory): 128/512 Bit • Dimensions (L x W x H): 18 mm x 122 mm x 2 mm 	UHF Transponder, rectangular, global	6068184
	<ul style="list-style-type: none"> • Carrier frequency: 865 MHz ... 928 MHz • Memory capacity (Ull / user memory): 496/128 Bit • Dimensions (L x W x H): 18 mm x 122 mm x 2 mm 	UHF Transponder, Rectangular, global	6088050

Recommended services

Additional services → www.sick.com/RFU62x

	Type	Part no.
Commissioning		
<ul style="list-style-type: none"> • Product area: RFID • Range of services: Inspection of connection, alignment, optimization of parameters of the RFU/RFH as well as tests, Setup of previously defined functions of reading configuration, data processing and network, interfaces and inputs and outputs • Duration: Additional work will be invoiced separately 	Commissioning RFU/RFH	1610018
Maintenance		
<ul style="list-style-type: none"> • Product area: RFID • Range of services: Inspection, analysis and restoring of defined functions, Checking and adjustment of reading configuration, data processing, network, interfaces and inputs and outputs as well as operating data • Duration: Additional work will be invoiced separately 	Maintenance RFU/RFH	1611424
Extended warranty		
<ul style="list-style-type: none"> • Product area: Machine vision, LiDAR sensors, safety camera sensors, Safety laser scanners, Safety radar sensors, Radar sensors, Fixed mount barcode scanners, Image-based code readers, RFID, Mobile handheld scanners • Range of services: The services correspond to the scope of the statutory manufacturer warranty (SICK general terms of delivery). • Duration: Five-year warranty from delivery date. 	Extended warranty for a total of five years from delivery date	1680671

SICK AT A GLANCE

SICK is one of the leading manufacturers of intelligent sensors and sensor solutions for industrial applications. A unique range of products and services creates the perfect basis for controlling processes securely and efficiently, protecting individuals from accidents and preventing damage to the environment.

We have extensive experience in a wide range of industries and understand their processes and requirements. With intelligent sensors, we can deliver exactly what our customers need. In application centers in Europe, Asia and North America, system solutions are tested and optimized in accordance with customer specifications. All this makes us a reliable supplier and development partner.

Comprehensive services complete our offering: SICK LifeTime Services provide support throughout the machine life cycle and ensure safety and productivity.

For us, that is “Sensor Intelligence.”

WORLDWIDE PRESENCE:

Contacts and other locations –www.sick.com