



RSB1-0662E120091PP3DZZZP0B

Roller Sensor Bar

MULTITASK PHOTOELECTRIC SENSORS

SICK
Sensor Intelligence.

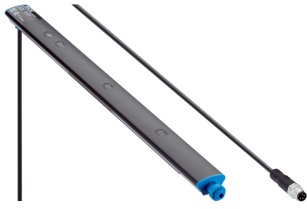

Illustration may differ



Ordering information

Type	Part no.
RSB1-0662E120091PP3DZZZP0B	1134561

Included in delivery: BEF-AP-RSBHEX (1)

Other models and accessories → www.sick.com/Roller_Sensor_Bar

Detailed technical data

Features

Functional principle	Photoelectric proximity sensor
Functional principle detail	Energetic
Sensing range	
Sensing range min.	2 mm
Sensing range max.	300 mm
Reference object	Object with 90% remission factor (complies with standard white according to DIN 5033)
Recommended sensing range for the best performance	2 mm ... 45 mm
Emitted beam	
Light source	LED
Type of light	Infrared light
Shape of light spot	Point-shaped
Light spot size (distance)	27 mm x 29 mm (45 mm)
Maximum dispersion of the emitted beam around the standardized transmission axis (squint angle)	< +/- 4° (at Ta = +23 °C)
Key LED figures	
LED risk group marking	Free group
Wave length	850 nm
Average service life	100,000 h at Ta = +25 °C
Number of beams	5
Beam separation	120 mm
Distance from 1st beam to leading edge of housing (including end cap)	91 mm
Smallest detectable object (MDO) typ.	120 mm (Dependent on distance between beams)
Adjustment	
None	-
Indication	
LED green	Operating indicator Static on: power on
LED yellow	Status of received light beam

	Static on: object present Static off: object not present
Special applications	Detecting flat objects, Detecting perforated objects, Detecting objects with position tolerances, Detecting uneven, shiny objects

Electronics

Supply voltage U_B	10 V DC ... 30 V DC
Ripple	$\leq 5 V_{pp}$
Usage category	DC-12 (According to EN 60947-5-2) DC-13 (According to EN 60947-5-2)
Current consumption	23 mA, without load. At $U_B = 24 V$
Protection class	III
Digital output	
Number	1
Type	PNP
Switching mode	Light switching
Signal voltage PNP HIGH/LOW	Approx. $U_B - 2.5 V / 0 V$
Output current I_{max}	$\leq 100 mA$
Circuit protection outputs	Reverse polarity protected Overcurrent protected Short-circuit protected
Response time	$\leq 1 ms$ ¹⁾
Repeatability (response time)	1 ms
Switching frequency	500 Hz ²⁾
Pin/Wire assignment	
BN 1	+ (L+)
WH 2	Q_2
BU 3	- (M)
BK 4	Q_1
Function of pin 4/black (BK)	Digital output, light switching, object present → output HIGH
Function of pin 2/white (WH)	Digital output, light switching, object present → output HIGH

¹⁾ Signal transit time with resistive load.

²⁾ With light/dark ratio 1:1.

Mechanics

Dimensions (W x H x D)	662 mm x 20.3 mm x 17 mm ¹⁾
Connection	Cable with connector M8, 4-pin, with knurled nut ²⁾
Connection detail	
Deep-freeze property	Do not bend below 0 °C
Conductor size	0.13 mm ²
Cable diameter	Ø 3.6 mm
Length of cable (L)	500 mm ²⁾
Material	

¹⁾ W = length of Roller Sensor Bar (in the installed state).

²⁾ Due to the manufacturing process, the cable can be a little longer.

Housing	Metal, Aluminum (anodised)
Front screen	Plastic, PMMA
Cable	Plastic, PVC
Male connector	Plastic, PVC
Weight	Approx. 240.3 g
Mounting system type	BEF-AP-RSBHEX, Hex adapter bracket

¹⁾ W = length of Roller Sensor Bar (in the installed state).

²⁾ Due to the manufacturing process, the cable can be a little longer.

Ambient data

Enclosure rating	IP67 (EN 60529)
Ambient operating temperature	-40 °C ... +60 °C
Ambient temperature, storage	-40 °C ... +75 °C
Shock resistance	30 g, 11 ms (3 positive and 3 negative shocks along X, Y, Z axes, 18 total shocks (EN60068-2-27))
Vibration resistance	10 Hz ... 55 Hz (Amplitude 1 mm, 3 x 30 min (EN60068-2-6))
Air humidity	15 % ... 95 %, relative humidity (no condensation), as per IEC 60947-5-2
Electromagnetic compatibility (EMC)	EN 60947-5-2
UL File No.	NRKH.E189383 & NRKH7.E189383

Classifications

ECLASS 5.0	27270904
ECLASS 5.1.4	27270904
ECLASS 6.0	27270904
ECLASS 6.2	27270904
ECLASS 7.0	27270904
ECLASS 8.0	27270904
ECLASS 8.1	27270904
ECLASS 9.0	27270904
ECLASS 10.0	27270904
ECLASS 11.0	27270904
ECLASS 12.0	27270903
ETIM 5.0	EC002719
ETIM 6.0	EC002719
ETIM 7.0	EC002719
ETIM 8.0	EC002719
UNSPSC 16.0901	39121528

Dimensional drawing (Dimensions in mm (inch))

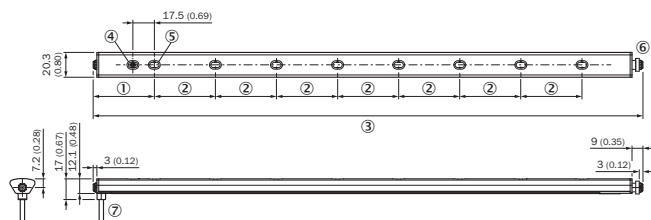

- ① Distance from 1st beam to leading edge of housing (including end cap)
- ② Beam separation
- ③ Length of Roller Sensor Bar (in the installed state)
- ④ Display and adjustment elements
- ⑤ First beam (number of beams varies depending on the variant)
- ⑥ Spring loaded end cap (for further information see the installation note)
- ⑦ Connection

Adjustments

Display and adjustment elements

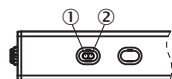

- ① LED green
- ② LED yellow

Installation note

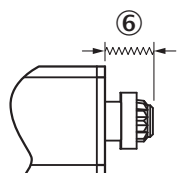

- ⑥ Range of motion of the spring loaded end cap (up to 5 mm of compression in uninstalled state)

Connection type

Male connector M8, 4-pin

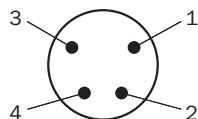

Characteristic curve

Operating reserve

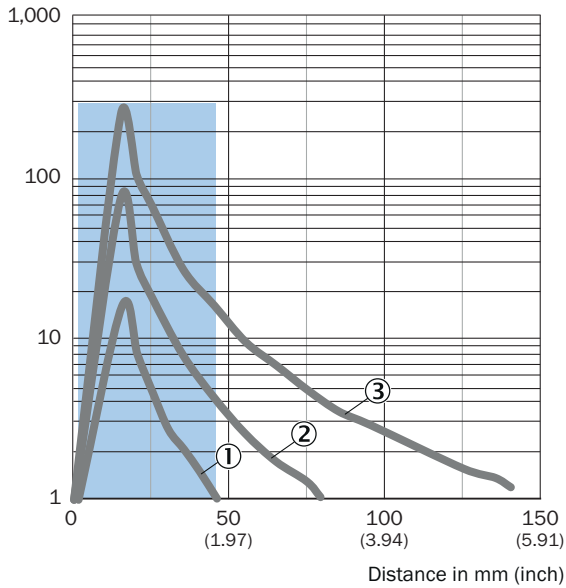

Recommended sensing range for the best performance

- ① Black object, 6% remission factor
- ② Gray object, 18% remission factor
- ③ White object, 90% remission factor

Light spot size

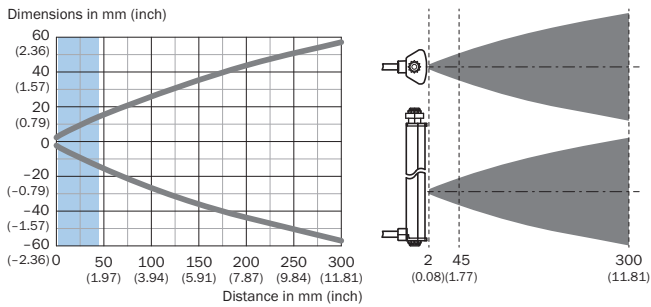



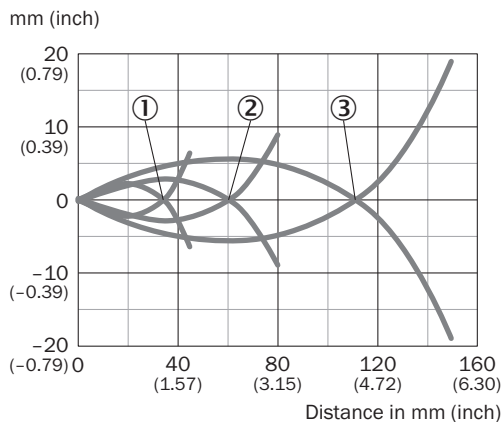



Recommended sensing range for the best performance



- ① Black object, 6% remission factor
- ② Gray object, 18% remission factor
- ③ White object, 90% remission factor

Recommended accessories

Other models and accessories → www.sick.com/Roller_Sensor_Bar

	Brief description	Type	Part no.
Mounting brackets and plates			
	8 mm round adapter bracket with adhesive back	BEF-AP-RSBADHA	2127765
	Adapter bracket with adhesive back	BEF-AP-RSBADHB	2127766
	Adapter bracket to snap between hex sections	BEF-AP-RSBCON	2127768
	Hex adapter bracket	BEF-AP-RSBHEX	2127767
	BEF-AP-RSBADHA, BEF-AP-RSBADHB, BEF-AP-RSBCON, BEF-AP-RSBHEX	BEF-AP-RSBKIT	2127759
Others			
	<ul style="list-style-type: none"> • Connection type head A: Male connector, M8, 4-pin, straight, A-coded • Description: Unshielded • Connection systems: Screw-type terminals • Permitted cross-section: 0.14 mm² ... 0.5 mm² 	STE-0804-G	6037323
	<ul style="list-style-type: none"> • Connection type head A: Female connector, M8, 4-pin, straight, A-coded • Connection type head B: Flying leads • Signal type: Sensor/actuator cable • Cable: 5 m, 4-wire, PVC • Description: Sensor/actuator cable, unshielded • Application: Zones with chemicals, Uncontaminated zones 	YF8U14-050VA3XLEAX	2095889

SICK AT A GLANCE

SICK is one of the leading manufacturers of intelligent sensors and sensor solutions for industrial applications. A unique range of products and services creates the perfect basis for controlling processes securely and efficiently, protecting individuals from accidents and preventing damage to the environment.

We have extensive experience in a wide range of industries and understand their processes and requirements. With intelligent sensors, we can deliver exactly what our customers need. In application centers in Europe, Asia and North America, system solutions are tested and optimized in accordance with customer specifications. All this makes us a reliable supplier and development partner.

Comprehensive services complete our offering: SICK LifeTime Services provide support throughout the machine life cycle and ensure safety and productivity.

For us, that is “Sensor Intelligence.”

WORLDWIDE PRESENCE:

Contacts and other locations –www.sick.com