



**RSB1-0856G118086PZEBZZZZZZ**

Roller Sensor Bar

**MULTITASK PHOTOELECTRIC SENSORS**

**SICK**  
Sensor Intelligence.

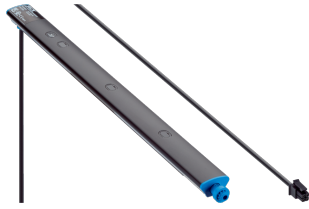

Illustration may differ



### Ordering information

Type	Part no.
RSB1-0856G118086PZEBZZZZZ	1136164

Other models and accessories → [www.sick.com/Roller\\_Sensor\\_Bar](http://www.sick.com/Roller_Sensor_Bar)

### Detailed technical data

#### Features

<b>Functional principle</b>	Photoelectric proximity sensor
<b>Functional principle detail</b>	Energetic
<b>Sensing range</b>	
Sensing range min.	2 mm
Sensing range max.	300 mm
Reference object	Object with 90% remission factor (complies with standard white according to DIN 5033)
Recommended sensing range for the best performance	2 mm ... 45 mm
<b>Emitted beam</b>	
Light source	LED
Type of light	Infrared light
Shape of light spot	Point-shaped
Light spot size (distance)	27 mm x 29 mm (45 mm)
Maximum dispersion of the emitted beam around the standardized transmission axis (squint angle)	< +/- 4° (at T <sub>a</sub> = +23 °C)
<b>Key LED figures</b>	
LED risk group marking	Free group
Wave length	850 nm
Average service life	100,000 h at T <sub>a</sub> = +25 °C
<b>Number of beams</b>	7
<b>Beam separation</b>	118 mm
<b>Distance from 1st beam to leading edge of housing (including end cap)</b>	86 mm
<b>Smallest detectable object (MDO) typ.</b>	118 mm (Dependent on distance between beams)
<b>Adjustment</b>	
None	-
<b>Indication</b>	
LED green	Operating indicator

	LED yellow	Static on: power on Status of received light beam Static on: object present Static off: object not present
<b>Special applications</b>		Detecting flat objects, Detecting perforated objects, Detecting objects with position tolerances, Detecting uneven, shiny objects

**Electronics**

<b>Supply voltage <math>U_B</math></b>		10 V DC ... 30 V DC
<b>Ripple</b>		$\leq 5 V_{pp}$
<b>Usage category</b>		DC-12 (According to EN 60947-5-2) DC-13 (According to EN 60947-5-2)
<b>Current consumption</b>		32 mA, without load. At $U_B = 24 V$
<b>Protection class</b>		III
<b>Digital output</b>		
	Number	1
	Type	PNP
	Switching mode	Light switching
	Signal voltage PNP HIGH/LOW	Approx. $U_B - 2.5 V / 0 V$
	Output current $I_{max}$	$\leq 100 mA$
	Circuit protection outputs	Reverse polarity protected Overcurrent protected Short-circuit protected
	Response time	$\leq 1 ms$ <sup>1)</sup>
	Repeatability (response time)	1 ms
	Switching frequency	500 Hz <sup>2)</sup>
<b>Pin/Wire assignment</b>		
	WH 1	Not connected
	BK 2	Q
	BU 3	-(M)
	BN 4	+(L+)
	Function of pin 2/white (WH)	Digital output, light switching, object present → output HIGH

<sup>1)</sup> Signal transit time with resistive load.

<sup>2)</sup> With light/dark ratio 1:1.

**Mechanics**

<b>Dimensions (W x H x D)</b>		856 mm x 20.3 mm x 17 mm <sup>1)</sup>
<b>Connection</b>		Cable with MOLEX-connector 43025-0400, 4-pin <sup>2)</sup>
<b>Connection detail</b>		
	Deep-freeze property	Do not bend below 0 °C
	Conductor size	0.13 mm <sup>2</sup>
	Cable diameter	Ø 3.6 mm
	Length of cable (L)	150 mm <sup>2)</sup>
<b>Material</b>		

<sup>1)</sup> W = length of Roller Sensor Bar (in the installed state).

<sup>2)</sup> Due to the manufacturing process, the cable can be a little longer.

Housing	Metal, Aluminum (anodised)
Front screen	Plastic, PMMA
Cable	Plastic, PVC
Male connector	Plastic, nylon
<b>Weight</b>	Approx. 310.6 g
<b>Mounting system type</b>	None

<sup>1)</sup> W = length of Roller Sensor Bar (in the installed state).

<sup>2)</sup> Due to the manufacturing process, the cable can be a little longer.

### Ambient data

<b>Enclosure rating</b>	IP67 (EN 60529)
<b>Ambient operating temperature</b>	-40 °C ... +60 °C
<b>Ambient temperature, storage</b>	-40 °C ... +75 °C
<b>Shock resistance</b>	30 g, 11 ms (3 positive and 3 negative shocks along X, Y, Z axes, 18 total shocks (EN60068-2-27))
<b>Vibration resistance</b>	10 Hz ... 55 Hz (Amplitude 1 mm, 3 x 30 min (EN60068-2-6))
<b>Air humidity</b>	15 % ... 95 %, relative humidity (no condensation), as per IEC 60947-5-2
<b>Electromagnetic compatibility (EMC)</b>	EN 60947-5-2
<b>UL File No.</b>	NRKH.E189383 & NRKH7.E189383

### Classifications

<b>ECLASS 5.0</b>	27270904
<b>ECLASS 5.1.4</b>	27270904
<b>ECLASS 6.0</b>	27270904
<b>ECLASS 6.2</b>	27270904
<b>ECLASS 7.0</b>	27270904
<b>ECLASS 8.0</b>	27270904
<b>ECLASS 8.1</b>	27270904
<b>ECLASS 9.0</b>	27270904
<b>ECLASS 10.0</b>	27270904
<b>ECLASS 11.0</b>	27270904
<b>ECLASS 12.0</b>	27270903
<b>ETIM 5.0</b>	EC002719
<b>ETIM 6.0</b>	EC002719
<b>ETIM 7.0</b>	EC002719
<b>ETIM 8.0</b>	EC002719
<b>UNSPSC 16.0901</b>	39121528

### Dimensional drawing (Dimensions in mm (inch))

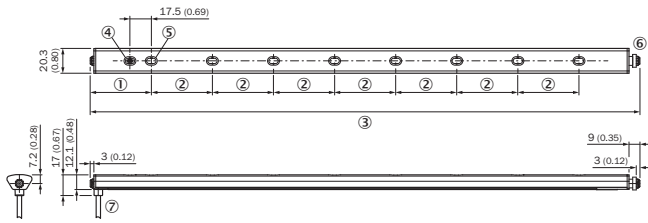

- ① Distance from 1st beam to leading edge of housing (including end cap)
- ② Beam separation
- ③ Length of Roller Sensor Bar (in the installed state)
- ④ Display and adjustment elements
- ⑤ First beam (number of beams varies depending on the variant)
- ⑥ Spring loaded end cap (for further information see the installation note)
- ⑦ Connection

### Adjustments

Display and adjustment elements



- ① LED green
- ② LED yellow

### Installation note

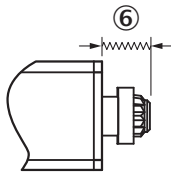

- ⑥ Range of motion of the spring loaded end cap (up to 5 mm of compression in uninstalled state)

### Connection type

Cable with MOLEX-connector

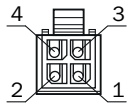

### Characteristic curve

Operating reserve



Recommended sensing range for the best performance

- ① Black object, 6% remission factor
- ② Gray object, 18% remission factor
- ③ White object, 90% remission factor

### Light spot size

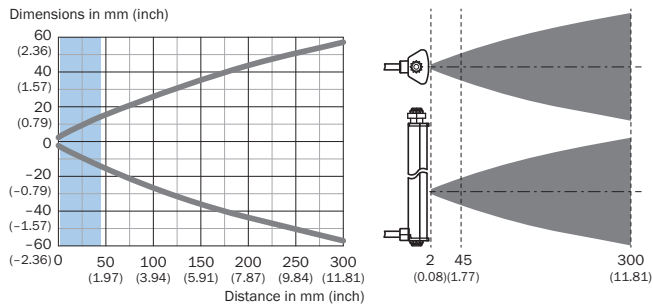





Recommended sensing range for the best performance



- ① Black object, 6% remission factor
- ② Gray object, 18% remission factor
- ③ White object, 90% remission factor

### Recommended accessories

Other models and accessories → [www.sick.com/Roller\\_Sensor\\_Bar](http://www.sick.com/Roller_Sensor_Bar)

	Brief description	Type	Part no.
<b>Mounting brackets and plates</b>			
	8 mm round adapter bracket with adhesive back	BEF-AP-RSBADHA	2127765
	Adapter bracket with adhesive back	BEF-AP-RSBADHB	2127766
	Adapter bracket to snap between hex sections	BEF-AP-RSBCON	2127768
	Hex adapter bracket	BEF-AP-RSBHEX	2127767
	BEF-AP-RSBADHA, BEF-AP-RSBADHB, BEF-AP-RSBCON, BEF-AP-RSBHEX	BEF-AP-RSBKIT	2127759

## SICK AT A GLANCE

SICK is one of the leading manufacturers of intelligent sensors and sensor solutions for industrial applications. A unique range of products and services creates the perfect basis for controlling processes securely and efficiently, protecting individuals from accidents and preventing damage to the environment.

We have extensive experience in a wide range of industries and understand their processes and requirements. With intelligent sensors, we can deliver exactly what our customers need. In application centers in Europe, Asia and North America, system solutions are tested and optimized in accordance with customer specifications. All this makes us a reliable supplier and development partner.

Comprehensive services complete our offering: SICK LifeTime Services provide support throughout the machine life cycle and ensure safety and productivity.

For us, that is “Sensor Intelligence.”

## WORLDWIDE PRESENCE:

Contacts and other locations –[www.sick.com](http://www.sick.com)