



# RZT7-03ZU0-KQ0

RZT7

SENSORS FOR T-SLOT CYLINDERS

**SICK**  
Sensor Intelligence.

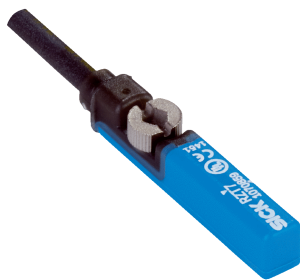

## Ordering information

| Type           | Part no. |
|----------------|----------|
| RZT7-03ZUO-KQ0 | 1082730  |

Other models and accessories → [www.sick.com/RZT7](http://www.sick.com/RZT7)



## Detailed technical data

### Features

|                                    |  |
|------------------------------------|--|
| <b>Cylinder type</b>               | T-slot   |
| <b>Cylinder types with adapter</b> | Profile cylinder<br>Tie rod cylinder<br>Round body cylinder<br>Dovetail groove cylinder<br>SMC rail CDQ2<br>SMC rail ECDQ2 |
| <b>Housing length</b>              | 32.5 mm  |
| <b>Switching output</b>            | Reed   |
| <b>Switching frequency</b>         | 400 Hz   |
| <b>Output function</b>             | NC   |
| <b>Electrical wiring</b>           | AC/DC 2-wire   |
| <b>Enclosure rating</b>            | IP65 <sup>1)</sup><br>IP67   |

<sup>1)</sup> According to EN 60529.

### Mechanics/electronics

|   |                          |
|---|--------------------------|
| <b>Supply voltage</b>                   | 5 V AC/DC ... 30 V AC/DC |
| <b>Voltage drop</b>                     | ≤ 3.5 V                  |
| <b>Continuous current I<sub>a</sub></b> | ≤ 100 mA <sup>1)</sup>   |
| <b>Switching capacity</b>               | ≤ 6 W                    |
| <b>Protection class</b>                 | III                      |
| <b>Response sensitivity, typ.</b>       | 3 mT                     |
| <b>Overrun distance, typ.</b>           | 10 mm                    |
| <b>Reproducibility</b>                  | ≤ 0.1 mT <sup>2)</sup>   |
| <b>Status indicator LED</b>             | No                       |
| <b>Ambient operating temperature</b>    | -30 °C ... +70 °C        |

<sup>1)</sup> AC/DC.

<sup>2)</sup> Supply voltage U<sub>B</sub> and constant ambient temperature T<sub>a</sub>.

|                                       |   |
|---------------------------------------|---|
| <b>Shock and vibration resistance</b> | 30 g, 11 ms / 10 ... 55 Hz, 1 mm  |
| <b>EMC</b>                            | According to EN 60947-5-2   |
| <b>Connection type</b>                | Cable with connector M12, 3-pin, with knurled nuts, drag chain use, 0.3 m                                 |
| <b>Connection type Detail</b>         |   |
| Conductor cross section               | 0.12 mm <sup>2</sup>  |
| Cable diameter                        | Ø 2.9 mm  |
| Bending radius                        | With fixed installation > 3 x cable diameter<br>For flexible use > 10 x cable diameter                    |
| Torsion force                         | ± 270° / 10 cm  |
| Torsion cycles                        | > 2,000,000   |
| Drag chain cycles                     | > 2,000,000   |
| Drag chain parameters                 | Traversing speed max. 3.3 m/s at 5 m horizontal traversing length<br>Acceleration max. 5 m/s <sup>2</sup> |
| Cable outlet                          | Axial   |
| <b>Material</b>                       |   |
| Housing                               | Plastic, Grilamid LVX-65H SST   |
| Cable                                 | PUR   |
| <b>UL File No.</b>                    | NRKH.E181493 & NRKH7.E181493  |

<sup>1)</sup> AC/DC.

<sup>2)</sup> Supply voltage  $U_B$  and constant ambient temperature  $T_a$ .

### Safety-related parameters

|                                     |  |
|-------------------------------------|--|
| <b>MTTF<sub>D</sub></b>             | 167,567 years                          |
| <b>DC<sub>avg</sub></b>             | 0 %                                    |
| <b>T<sub>M</sub> (mission time)</b> | 20 years                               |
| <b>B<sub>10d</sub></b>              | 500,000 Switching cycles <sup>1)</sup> |

<sup>1)</sup> Only for devices containing electro-mechanical components. In this case, the MTTFD value of the entire device must be calculated from the given B10D value, the number of switching cycles and the given MTTFD value.

### Classifications

|                     |          |
|---------------------|----------|
| <b>ECLASS 5.0</b>   | 27270104 |
| <b>ECLASS 5.1.4</b> | 27270104 |
| <b>ECLASS 6.0</b>   | 27270104 |
| <b>ECLASS 6.2</b>   | 27270104 |
| <b>ECLASS 7.0</b>   | 27270104 |
| <b>ECLASS 8.0</b>   | 27270104 |
| <b>ECLASS 8.1</b>   | 27270104 |
| <b>ECLASS 9.0</b>   | 27270104 |
| <b>ECLASS 10.0</b>  | 27270104 |
| <b>ECLASS 11.0</b>  | 27270104 |
| <b>ECLASS 12.0</b>  | 27274301 |
| <b>ETIM 5.0</b>     | EC002544 |
| <b>ETIM 6.0</b>     | EC002544 |
| <b>ETIM 7.0</b>     | EC002544 |

|                       |          |
|-----------------------|----------|
| <b>ETIM 8.0</b>       | EC002544 |
| <b>UNSPSC 16.0901</b> | 39122230 |

## Installation note

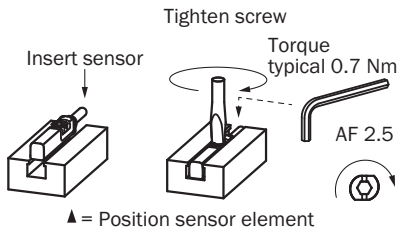

## Connection diagram

Cd-449

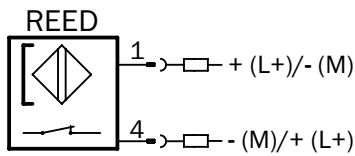

## Dimensional drawing (Dimensions in mm (inch))

Cable with connector M12, with knurled nuts

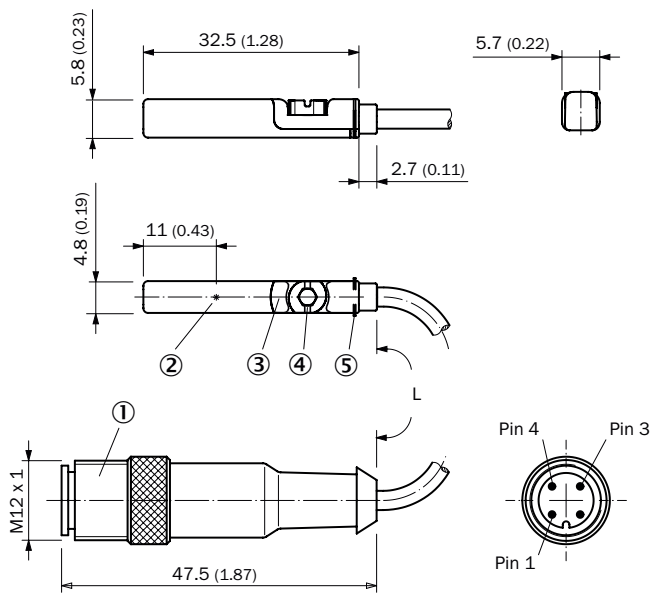



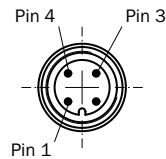



- ① Connection
- ② Position sensor element
- ③ Fixing screw SW 2.5
- ④ Retaining ribs



| Part no. | Type              | L      | Number of cores | Supply voltage           |
|----------|-------------------|--------|-----------------|--------------------------|
| 1082730  | RZT7-03ZUO-KQ0    | 300 mm | 2               | 5 V AC/DC ... 30 V AC/DC |
| 1109287  | RZT7-03ZUO-KQ0S17 | 300 mm | 2               | 5 V AC/DC ... 30 V AC/DC |
| 1110064  | RZT7-03ZUP-KQ0S18 | 300 mm | 3               | 5 V AC/DC ... 30 V AC/DC |

## Recommended accessories

Other models and accessories → [www.sick.com/RZT7](http://www.sick.com/RZT7)

|   | Brief description  | Type            | Part no. |
|---|--|-----------------|----------|
| <b>Brackets for cylinder sensors</b>  |  |                 |          |
|    | Mounting bracket for cylinder with dovetail slot, Aluminum, without mounting hardware  | BEF-KHZ-ST1     | 2022703  |
|    | Mounting bracket for integrated profile cylinder/tie-rod cylinder, zinc diecast, mounting hardware included  | BEF-KHZ-PT1     | 2022702  |
|    | 1 piece, Mounting bracket on round body cylinder with piston diameter of 12 mm, ambient temperature min 0 °C max 50 °C, plastic, Aluminum                      | BEF-KHZ-RT-12   | 2077681  |
|   | 1 piece, Mounting bracket on round body cylinder with piston diameter of 16 mm, ambient temperature min 0 °C max 50 °C, plastic, Aluminum                      | BEF-KHZ-RT-16   | 2077680  |
|   | 1 piece, Mounting bracket on round body cylinder with piston diameter of 20 mm, ambient temperature min 0 °C max 50 °C, plastic, Aluminum                      | BEF-KHZ-RT-20   | 2077679  |
|   | 1 piece, Mounting bracket on round body cylinder with piston diameter of 25 mm, ambient temperature min 0 °C max 50 °C, plastic, Aluminum                      | BEF-KHZ-RT-25   | 2077678  |
|   | 1 piece, Mounting bracket on round body cylinder with piston diameter of 32 mm, ambient temperature min 0 °C max 50 °C, plastic, Aluminum                      | BEF-KHZ-RT-32   | 2077677  |
|   | 1 piece, Mounting bracket on round body cylinder with piston diameter of 40 mm, ambient temperature min 0 °C max 50 °C, plastic, Aluminum                      | BEF-KHZ-RT-40   | 2077676  |
|   | 1 piece, Mounting bracket on round body cylinder with piston diameter of 50 mm, ambient temperature min 0 °C max 50 °C, plastic, Aluminum                      | BEF-KHZ-RT-50   | 2077675  |
|   | 1 piece, Mounting bracket on round body cylinder with piston diameter of 63 mm, ambient temperature min 0 °C max 50 °C, plastic, Aluminum                      | BEF-KHZ-RT-63   | 2077674  |
|  | 1 piece, Mounting bracket on round body cylinder with piston diameter of 8 mm ... 130 mm, ambient temperature min -30 °C max 80 °C, stainless steel, Zinc cast | BEF-KHZ-RT1-130 | 2077684  |
|   | 1 piece, Mounting bracket on round body cylinder with piston diameter of 8 mm ... 25 mm, ambient temperature min -30 °C max 80 °C, stainless steel, Zinc cast  | BEF-KHZ-RT1-25  | 2077682  |
|   | 1 piece, Mounting bracket on round body cylinder with piston diameter of 8 mm ... 63 mm, ambient temperature min -30 °C max 80 °C, stainless steel, Zinc cast  | BEF-KHZ-RT1-63  | 2077683  |
|  | Mounting bracket for mounting on SMC rails CDQ2 (T-slot), Aluminum, without mounting hardware  | BEF-KHZ-TT2     | 2046440  |
|  | Mounting bracket for mounting on SMC rails ECDQ2 (T-slot), Aluminum, without mounting hardware   | BEF-KHZ-TT1     | 2046439  |

|   | <b>Brief description</b>                                      | <b>Type</b> | <b>Part no.</b> |
|---|---|-------------|-----------------|
| Device protection (mechanical)  |   |             |                 |
|  | Protective adapter, die-cast zinc, mounting hardware included | BEF-SG-MRZT | 2077201         |

## SICK AT A GLANCE

SICK is one of the leading manufacturers of intelligent sensors and sensor solutions for industrial applications. A unique range of products and services creates the perfect basis for controlling processes securely and efficiently, protecting individuals from accidents and preventing damage to the environment.

We have extensive experience in a wide range of industries and understand their processes and requirements. With intelligent sensors, we can deliver exactly what our customers need. In application centers in Europe, Asia and North America, system solutions are tested and optimized in accordance with customer specifications. All this makes us a reliable supplier and development partner.

Comprehensive services complete our offering: SICK LifeTime Services provide support throughout the machine life cycle and ensure safety and productivity.

For us, that is “Sensor Intelligence.”

## WORLDWIDE PRESENCE:

Contacts and other locations –[www.sick.com](http://www.sick.com)