



SG2-AAA00011IA0000

scanGrid2

SAFETY MULTIBEAM SCANNERS

SICK
Sensor Intelligence.



Ordering information

Type	Part no.
SG2-AAA00011IA0000	1101561

Other models and accessories → www.sick.com/scanGrid2



Detailed technical data

Features

Protective field range	1.1 m (At a resolution of 70 mm)
Warning field range	4 m (At a resolution of 70 mm and a remission of 80%)
Number of simultaneously monitored fields	≤ 2 ¹⁾
Number of fields	8
Number of monitoring cases	4
Scanning angle	150°
Resolution (can be configured)	50 mm, 70 mm, 150 mm, 200 mm
Angular resolution	6°
Response time	≥ 60 ms
Number of multiple samplings	1 ... 4
Protective field supplement	100 mm
Items supplied	Safe multibeam scanner Safety instruction Mounting instructions Operating instructions for download

¹⁾ Protective and warning field.

Safety-related parameters

Type	Type 2 (IEC 61496-3)
Safety integrity level	SIL 1 (IEC 61508)
Category	Category 2 (ISO 13849-1)
Performance level	PL c (ISO 13849-1)
PFH_D (mean probability of a dangerous failure per hour)	1.3 × 10 ⁻⁶
T_M (mission time)	20 years (ISO 13849-1)
Safe state in the event of a fault	At least one OSSD is in the OFF state.

Functions

Restart delay	✓
Multiple sampling	✓
Monitoring case switching	✓

Switch-on delay for monitoring case switching	✓
Simultaneous monitoring	✓
Static protective field switching	✓
Integrated configuration memory	✓
Measured data output	None
Cascading	✓

Interfaces

Connection type	Connector M12, 8-pin, A-coded
Outputs	
OSSD pairs	1
Universal outputs	1
Inputs	
Static control inputs	3
Near Field Communication (NFC)	✓
Configuration method	Via software
Configuration and diagnostic software	Safety Designer (software for configuring and diagnosing safety solutions from SICK AG) Safety Assistant (app for transferring configurations and diagnosing safety solutions from SICK AG)
Configuration and diagnostics interface	USB 2.0 type C (Safety Designer) NFC (Safety Assistant app)
Display elements	LEDs

Electrical data

Protection class	III (IEC 61140)
Supply voltage V_S	24 V DC (8.4 V ... 30 V) ¹⁾
Supply voltage U_V in a cascade	24 V DC (14 V ... 30 V) ¹⁾
Residual ripple	$\leq 10\%$ ²⁾
Power consumption	≤ 3 W (DC)
Output signal switching devices (OSSDs)	
Type of output	2 semiconductors, short-circuit protected, cross-circuit monitored ³⁾
Output mode (can be configured)	PNP or NPN ^{4) 5)}
PNP mode (for safety functions)	
ON state, switching voltage HIGH	$(U_V - 2.25\text{ V}) \dots U_V$
OFF state, switching voltage LOW	≤ 2 V
Current-carrying capacity per OSSD	≤ 200 mA
NPN mode	
ON state, switching voltage LOW	≤ 2.25 V
OFF state, switching voltage HIGH	$(U_V - 2\text{ V}) \dots U_V$

¹⁾ SELV/PELV safety/protective extra-low voltage.

²⁾ Within the limits of V_S .

³⁾ Applies to the voltage range between -30 V and +30 V.

⁴⁾ For safety functions, you must always use PNP mode (default setting).

⁵⁾ Both OSSDs of the safe multibeam scanner always use the same mode.

Current-carrying capacity per OSSD	≤ 200 mA
------------------------------------	----------

- 1) SELV/PELV safety/protective extra-low voltage.
- 2) Within the limits of V_S .
- 3) Applies to the voltage range between -30 V and +30 V.
- 4) For safety functions, you must always use PNP mode (default setting).
- 5) Both OSSDs of the safe multibeam scanner always use the same mode.

Mechanical data

Dimensions (W x H x D)	160 mm x 43 mm x 56 mm
Weight	170 g
Housing material	Durabio (front part, black) Polycarbonate (back part, colza yellow)
Housing color	RAL 9005 (black) RAL 1021 (yellow)

Ambient data

Enclosure rating	IP65 (IEC 60529)
Ambient light immunity	≤ 10 klx
Ambient operating temperature	0 °C ... +50 °C
Storage temperature	-30 °C ... +70 °C
Air humidity	15 % ... 95 %, Non-condensing
Vibration resistance	IEC 60068-2-6, IEC 60068-2-64, IEC 60721-3-5, IEC TR 60721-4-5, IEC 61496-3
Class	5M1 (IEC 60721-3-5)
Shock resistance	IEC 60068-2-27, IEC 60721-3-5, IEC TR 60721-4-5, IEC 61496-3
Class	5M1 (IEC 60721-3-5)
Single shock	150 m/s ² , 11 ms
Continuous shock	100 m/s ² , 16 ms
EMC	IEC 61496-1, IEC 61000-6-2, IEC 61000-6-3

Other information

Type of light	Pulsed laser diode
Wave length	850 nm
Detectable remission factor	4% ... several 1,000%
Laser class	1

Classifications

ECLASS 5.0	27272705
ECLASS 5.1.4	27272705
ECLASS 6.0	27272705
ECLASS 6.2	27272705
ECLASS 7.0	27272705
ECLASS 8.0	27272705
ECLASS 8.1	27272705
ECLASS 9.0	27272705
ECLASS 10.0	27272705
ECLASS 11.0	27272705

ECLASS 12.0	27272705
ETIM 5.0	EC002550
ETIM 6.0	EC002550
ETIM 7.0	EC002550
ETIM 8.0	EC002550
UNSPSC 16.0901	39121528

Dimensional drawing (Dimensions in mm (inch))

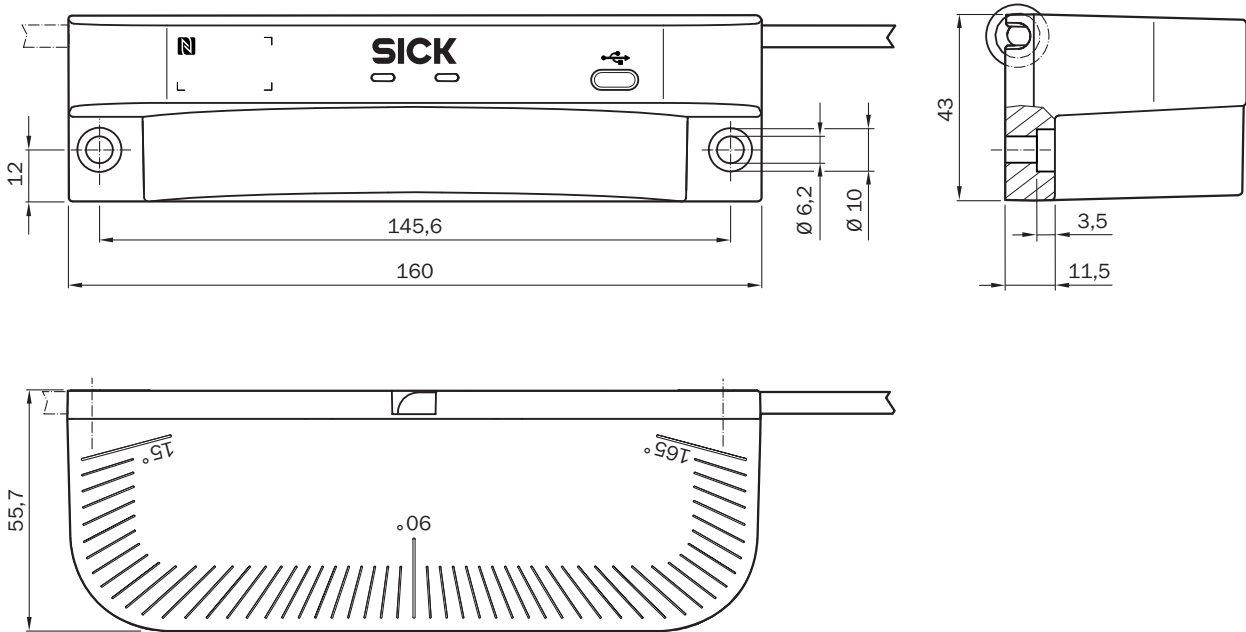

Pinouts

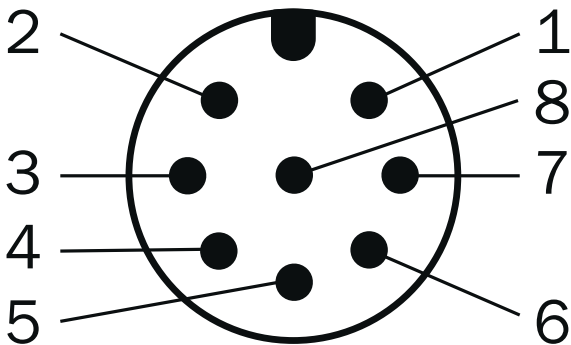







Pin	Designation	Description
1	+24 V DC	Supply voltage +24 V DC
2	OSSD1	OSSD1





Pin	Designation	Description
3	0 V DC	Supply voltage 0 V DC
4	OSSD2	OSSD2
5	Uni-0	Universal output, configurable: Monitoring result, contamination, error
6	IN 1	Control input 1: Monitoring case switching
7	IN 2	Control input 2: Monitoring case switching
8	IN 3	Control input 3: Monitoring case switching

For details see operating instructions

Recommended accessories

Other models and accessories → www.sick.com/scanGrid2

	Brief description	Type	Part no.
Other adapters			
	Connector for cascading safe multibeam scanners Connection option for 2 scanGrid2 units or connection option for 1 scanGrid2 unit and 1 additional Multi Sensor Connector.	scanGrid2 Multi Sensor Connector	2118543
Terminal and alignment brackets			
	Alignment bracket for scanGrid2, can be aligned ± 10°	BEF-1GHAHVKU1	2116913
	<ul style="list-style-type: none"> • Connection type head A: Female connector, M12, 8-pin, straight, A-coded • Connection type head B: Male connector, M12, 8-pin, straight, A-coded • Signal type: Sensor/actuator cable • Cable: 1 m, 8-wire, PUR, halogen-free • Description: Sensor/actuator cable, unshielded • Application: Zones with oils and lubricants, Drag chain operation, Robot 	YF2A18-010UA5M2A18	2096032
	<ul style="list-style-type: none"> • Connection type head A: Female connector, M12, 8-pin, straight, A-coded • Connection type head B: Male connector, M12, 8-pin, straight, A-coded • Signal type: Sensor/actuator cable • Cable: 2 m, 8-wire, PUR, halogen-free • Description: Sensor/actuator cable, unshielded • Application: Zones with oils and lubricants, Drag chain operation, Robot 	YF2A18-020UA5M2A18	2096033
	<ul style="list-style-type: none"> • Connection type head A: Female connector, M12, 8-pin, straight, A-coded • Connection type head B: Male connector, M12, 8-pin, straight, A-coded • Signal type: Sensor/actuator cable • Cable: 5 m, 8-wire, PUR, halogen-free • Description: Sensor/actuator cable, unshielded • Application: Zones with oils and lubricants, Drag chain operation, Robot 	YF2A18-050UA5M2A18	2096034
	<ul style="list-style-type: none"> • Connection type head A: Female connector, M12, 8-pin, straight, A-coded • Connection type head B: Male connector, M12, 8-pin, straight, A-coded • Signal type: Sensor/actuator cable • Cable: 0.5 m, 8-wire, PUR, halogen-free • Description: Sensor/actuator cable, unshielded • Application: Zones with oils and lubricants, Drag chain operation, Robot 	YF2A18-C50UA5M2A18	2108996

	Brief description	Type	Part no.
	<ul style="list-style-type: none"> • Connection type head A: Female connector, M12, 8-pin, straight, A-coded • Connection type head B: Flying leads • Signal type: Sensor/actuator cable • Cable: 2 m, 8-wire, PUR, halogen-free • Description: Sensor/actuator cable, unshielded • Connection systems: Flying leads • Application: Zones with oils and lubricants, Drag chain operation 	DOL-1208G02MD25KM1	2079314
	<ul style="list-style-type: none"> • Connection type head A: Female connector, M12, 8-pin, straight, A-coded • Connection type head B: Flying leads • Signal type: Sensor/actuator cable • Cable: 5 m, 8-wire, PUR, halogen-free • Description: Sensor/actuator cable, unshielded • Connection systems: Flying leads • Application: Zones with oils and lubricants, Drag chain operation 	DOL-1208G05MD25KM1	2079315
	<ul style="list-style-type: none"> • Connection type head A: Female connector, M12, 8-pin, straight, A-coded • Connection type head B: Flying leads • Signal type: Sensor/actuator cable • Cable: 10 m, 8-wire, PUR, halogen-free • Description: Sensor/actuator cable, unshielded • Connection systems: Flying leads • Application: Zones with oils and lubricants, Drag chain operation 	DOL-1208G10MD25KM1	2079316
	<ul style="list-style-type: none"> • Connection type head A: Male connector, USB-C, 4-pin, straight • Connection type head B: Male connector, USB-A, 4-pin, straight • Cable: 2 m, PVC • Description: scanGrid2 configuration cable 	YMUSA4-020VG5MUSC4	2119989

SICK AT A GLANCE

SICK is one of the leading manufacturers of intelligent sensors and sensor solutions for industrial applications. A unique range of products and services creates the perfect basis for controlling processes securely and efficiently, protecting individuals from accidents and preventing damage to the environment.

We have extensive experience in a wide range of industries and understand their processes and requirements. With intelligent sensors, we can deliver exactly what our customers need. In application centers in Europe, Asia and North America, system solutions are tested and optimized in accordance with customer specifications. All this makes us a reliable supplier and development partner.

Comprehensive services complete our offering: SICK LifeTime Services provide support throughout the machine life cycle and ensure safety and productivity.

For us, that is “Sensor Intelligence.”

WORLDWIDE PRESENCE:

Contacts and other locations –www.sick.com