



SLG10S-160FBR21D45

SLG-2

SWITCHING AUTOMATION LIGHT GRIDS

SICK
Sensor Intelligence.



Illustration may differ



Ordering information

| Type | Part no. |
|--------------------|----------|
| SLG10S-160FBR21D45 | 1142221 |

Other models and accessories → www.sick.com/SLG-2

Detailed technical data

Features

| | |
|---|---|
| Included with delivery | 1 × sender 1 × receiver 1 × Quick Start Guide 1 × safety instruction |
| Functional principle | Sender/receiver |
| Sensing range | |
| Limit values | 500 mm ... 8,500 mm |
| Parallel beam (recommended) | 500 mm ... 6,000 mm |
| 9 x cross beam (recommended) | 500 mm ... 6,000 mm |
| Blind zone | |
| Distance from 1st Beam to leading edge of housing (connection side) | 4.6 mm |
| Distance from last beam to leading edge of housing (top) | 4.6 mm ¹⁾ |
| Detection height | 1,600 mm |
| Beam separation | 10 mm |
| Optical light exit | Flat |
| Detection capability | |
| Minimum detectable object (MDO), parallel beam | 15 mm ²⁾ |

¹⁾ For a detection height < 700 mm, the measured value can vary by up to 1 mm from the measured values specified here.

²⁾ MDO: Minimum detectable size of an arbitrarily shaped object.

³⁾ MOW: Minimum detectable width of an arbitrarily thin object.

⁴⁾ % value relates to the installed distance between the sender and receiver.

⁵⁾ Depends on the sensing range / number of beams / cross beam.

| | |
|---|---|
| Minimum detectable object (MDO), 9 x cross beam | ≥ 6.5 mm ²⁾ |
| Minimum object width (MOW), 9 x cross beam | 26 % ³⁾ ⁴⁾ |
| Factory setting | |
| Beam function | 9 x cross beam |
| Pin 2 (MF) | Teach-in input |
| Pin 4 (OUT) | Object detection output = "LOW" |
| IO-Link (process data) | Q _L /Q _{int} Status, System status, Beam status |
| Teach-in (default) | Teach-in input |
| Adjustment | |
| IO-Link | For configuring the sensor parameters and Smart Task functions |
| Emitted beam | |
| Light source | LED |
| Type of light | Infrared light |
| Number of beams | 160 |
| LED key figures | |
| Normative reference | EN 62471:2008-09 IEC 62471:2006, modified |
| LED risk group marking | Free group |
| Wave length | 850 nm |
| Average service life | Average service life: 100,000 h at T _U = +25 °C |
| Time specifications | |
| Initialization time | 0.4 s ... 2 s ⁵⁾ |
| Teach-in time | 0.75 s ... 50 s ⁵⁾ |
| Scan time, parallel beam | 11.6 ms |
| Scan time, cross beam | 23.2 ms |
| Repeatability, parallel beam | 11.6 ms |
| Repeatability, cross beam | 34.8 ms |
| Minimum dwell time, parallel beam | 46.4 ms |
| Minimum dwell time, cross beam | 92.8 ms |
| Max. response time, parallel beam | 60.2 ms |
| Max. response time, cross beam | 117.3 ms |
| Type of synchronization | Optical (2 beams) |

¹⁾ For a detection height < 700 mm, the measured value can vary by up to 1 mm from the measured values specified here.

²⁾ MDO: Minimum detectable size of an arbitrarily shaped object.

³⁾ MOW: Minimum detectable width of an arbitrarily thin object.

⁴⁾ % value relates to the installed distance between the sender and receiver.

⁵⁾ Depends on the sensing range / number of beams / cross beam.

Communication interface

| | |
|------------------------|--------------------|
| IO-Link | ✓, V1.1 |
| Data transmission rate | COM3 (230,4 kBaud) |
| Maximum cable length | 20 m |
| Cycle time | 2.3 ms |
| Process data length | 32 Byte |

Electrical data

| | |
|--|--|
| Supply voltage U_B | DC 18 V DC ... 30 V DC ¹⁾ |
| Ripple | $\leq 1.3 V_{pp}$ |
| Power consumption | |
| Sender | $\leq 65 \text{ mA}^{2)}$ |
| Receiver | $\leq 135 \text{ mA}^{2)}$ |
| Digital output | |
| Number | 2 |
| Type | Push-pull: PNP/NPN |
| Output signal voltage HIGH/LOW | $U_B - 3 \text{ V} / < 3 \text{ V}$ |
| Output load, Inductive | 1 H |
| Output load, capacitive | 100 nF |
| Output current $I_{max.}$ | 100 mA |
| Output current, rest | < 0.5 mA |
| Digital input | |
| Number | 1 |
| Input signal voltage HIGH/LOW | >15 V / <5 V |
| Protection class | III ³⁾ |
| UL File No. | NRKH.E181493 & NRKH7.E181493 |
| Circuit protection | U_V connections, reverse polarity protected Output Q short-circuit protected Outputs overcurrent and short-circuit protected |

¹⁾ Without load.

²⁾ At 24 V.

³⁾ EN 61140.

Mechanical data

| | |
|--|--------------------------------------|
| Dimensions (W x H x D) | |
| Width | 11.8 mm |
| Height | 1,599.2 mm |
| Depth | 24.1 mm |
| Connection type | Cable with M12 male connector, 4-pin |
| Connection type Detail | |
| Cable diameter | 3.4 mm |
| Conductor cross section | 0.14 mm ² |
| Length of cable | 150 mm |
| Cable material | PVC |
| Material | |
| Housing | Aluminumplastic |
| Front screen | PMMA |
| Weight | 2,160 g |
| Overvoltage protection (required) | 1 |

Ambient data

| | |
|--|---|
| Enclosure rating | IP65, IP67 ¹⁾ |
| Ambient temperature, operation | -25 °C ... +55 °C |
| Ambient temperature, storage | -25 °C ... +70 °C |
| Ambient light immunity | Indirect: 50,000 lx ²⁾ |
| Shock resistance | 10 g, 16 ms, DIN EN 60068-2-27 |
| Vibration resistance | 10-150 Hz 0.5 mm, IEC 60068-2-6 |
| Air humidity | ≤ 96 %, relative humidity (no condensation) |
| Electromagnetic compatibility (EMC) | EN 61000-6-2, EN 61000-6-4 |

¹⁾ Operating in outdoor condition only with a external protection housing.

²⁾ Sunlight.

Smart Task

| | |
|----------------------------------|---|
| Smart Task name | Base logics |
| Logic function | Direct AND OR |
| Timer function | Deactivated Switch-on delay Off delay ON and OFF delay Impulse (one shot) |
| Switching signal | |
| Switching signal Q _{L1} | Switching output |
| Switching signal Q _{L2} | Switching output, external input |

Diagnosis

| | |
|------------------------------|--|
| Diagnostics functions | |
| Device state | Hardware error, temperature warning, operating hours warning |
| Communication state | Pin short-circuit error, invalid process data |
| Status of the light signal | Teach error, synchronization error, quality-of-run alarm |
| Alarm output | Yes |

Dimensional drawing (Dimensions in mm (inch))

Dimensional drawing, sensor

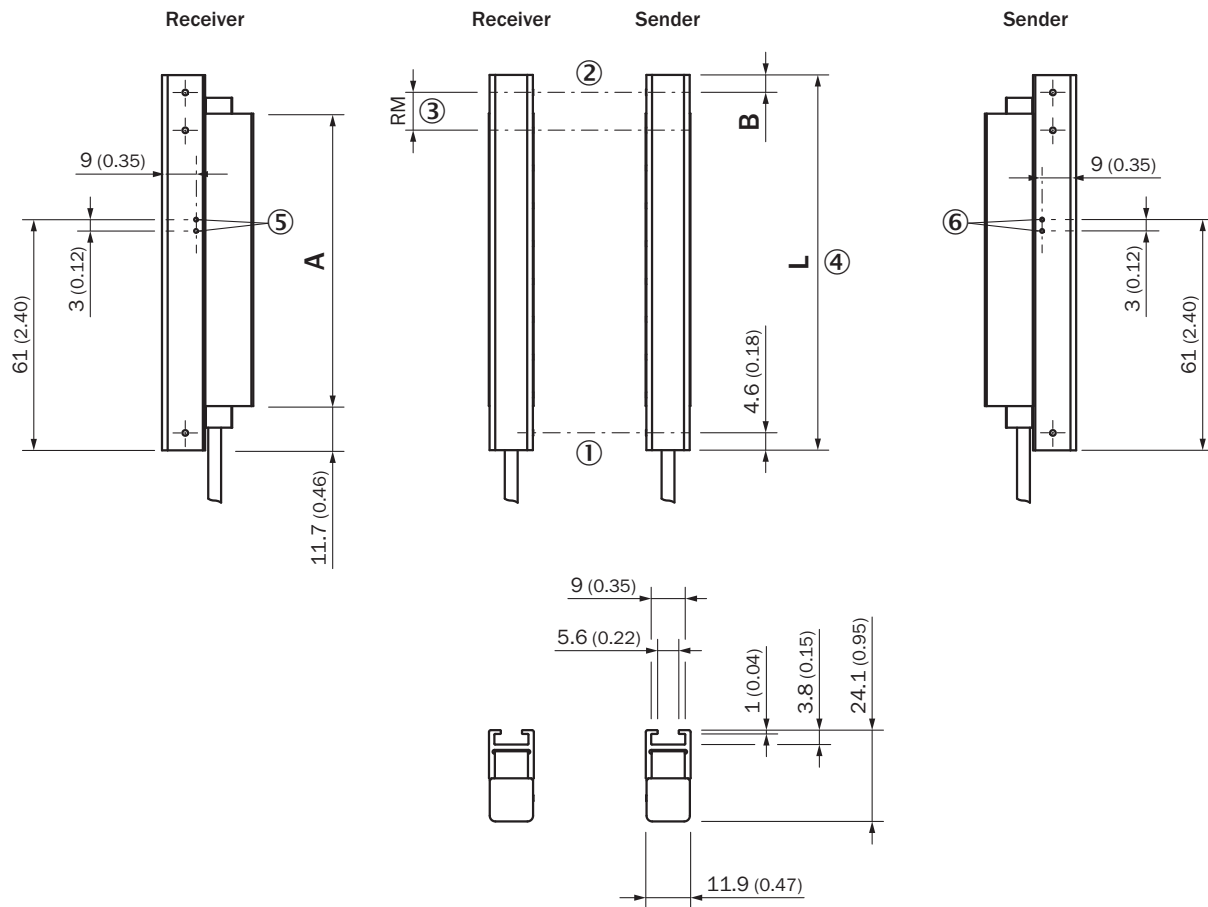

SLGxxx-xxxFxxxxxx

- ① First beam
- ② Last beam
- ③ Beam separation (RM)
- ④ Housing length
- ⑤ LED display receiver
- ⑥ LED display sender

Dimensional drawing, connection type

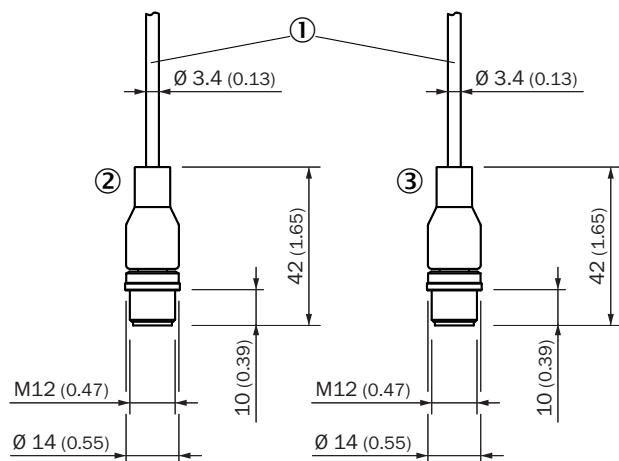

Cable with M12 male connector

- ① Connection (see technical data for length of cable)
- ② Receiver
- ③ Sender

| Dimensions in mm (inch) | | |
|----------------------------|--|-----------------|
| | Length of stabilizer | Housing length |
| | A | L |
| SLGxxx- 01 0xxxxxxx | 77 (3.03) | 99,2 (3.91) |
| SLGxxx- 02 0xxxxxxx | 178 (7.01) | 199,2 (7.84) |
| SLGxxx- 03 0xxxxxxx | 276 (10.87) | 299,2 (11.78) |
| SLGxxx- 04 0xxxxxxx | 376 (14.8) | 399,2 (15.72) |
| SLGxxx- 05 0xxxxxxx | 475 (18.7) | 499,2 (19.65) |
| SLGxxx- 06 0xxxxxxx | 576 (22.68) | 599,2 (23.6) |
| SLGxxx- 07 0xxxxxxx | 676 (26.61) | 699,2 (27.53) |
| SLGxxx- 08 0xxxxxxx | 776 (30.55) | 799,2 (31.46) |
| SLGxxx- 100 xxxxxxx | 975 (38.39) | 999,2 (39.34) |
| SLGxxx- 120 xxxxxxx | 1.175 (46.26) | 1.199,2 (47.21) |
| SLGxxx- 140 xxxxxxx | 1.374 (54.09) | 1.399,2 (55.09) |
| SLGxxx- 160 xxxxxxx | 1.574 (61.97) | 1.599,2 (62.96) |
| SLGxxx- 180 xxxxxxx | 1.774 (69.84) | 1.799,2 (70.83) |
| SLGxxx- 20 0xxxxxxx | 1.973 (77.68) | 1.999,2 (78.71) |
| SLGxxx- 220 xxxxxxx | 2.173 (85.55) | 2.199,2 (86.58) |
| SLGxxx- 240 xxxxxxx | 2.372 (93.39) | 2.399,2 (94.46) |
| | Distance: Housing edge - last beam | |
| | B¹⁾ | |
| SLG 10 x-xxxxxxxxxx | 4,6 (0.18) | |
| SLG 25 x-xxxxxxxxxx | 19,6 (0.77) | |
| SLG 50 x-xxxxxxxxxx | 44,6 (1.76) | |
| 1) | for detection height less than 700 mm, the dimension deviates up to 1 mm from the dimensions specified here. | |

Pinouts

Pinouts

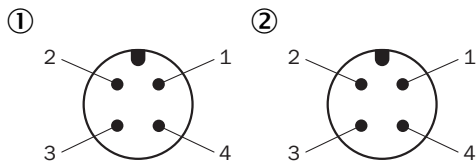

M12 male connector, 4-pin, A-coding

- ① Receiver
- ② Sender

Connection diagram

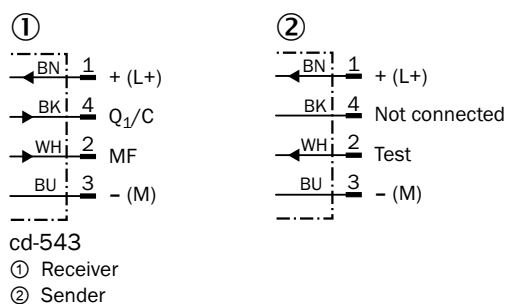

Instruction for installation

Slim & Flat

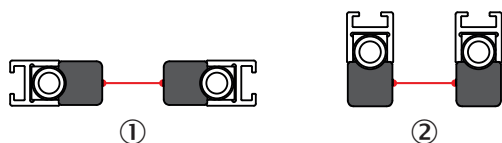

- ① Slim model = light emission on narrow side
- ② Flat model = light emission on broad side

Minimum distance to reflective materials

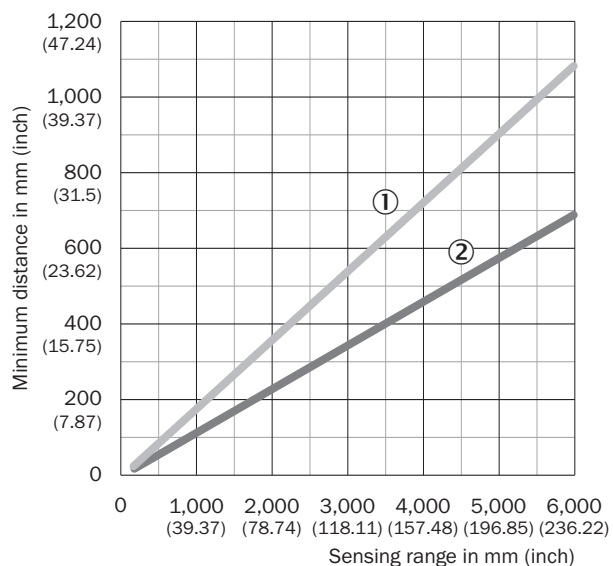

Depending on the sensing range, make sure that there are no reflective objects in the field of view of the light grid pair

- ① Minimum distance (safe)
- ② Minimum distance (typical)

Minimum distance between 2 light grids

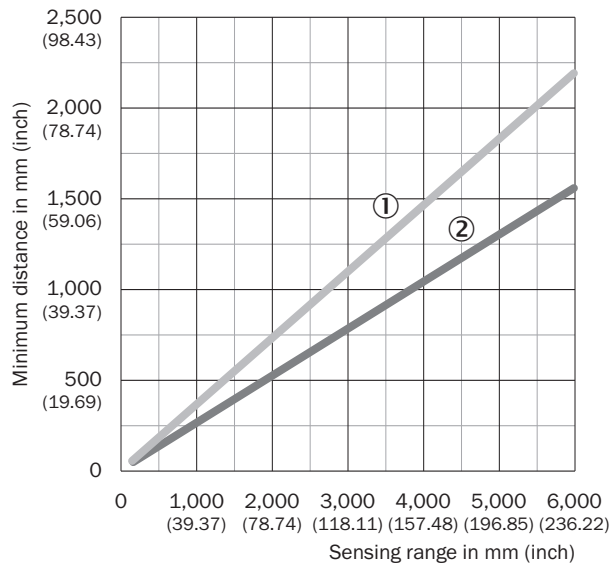

If not installed in opposition, make sure the minimum distance between the two light grid pairs is adhered to

- ① Minimum distance (safe)
- ② Minimum distance (typical)

Detection capability

Minimum object width (MOW)

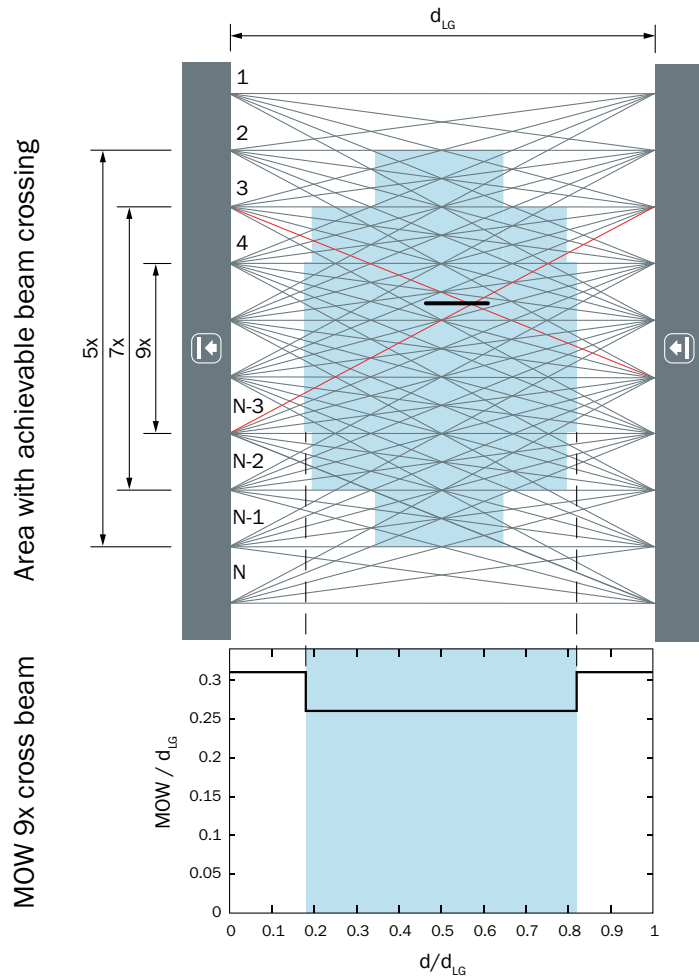

d_{LG} = Installed working distance between sender and receiver
 d = Distance to sender or receiver related to the installed working distance

Minimum detectable object (MDO)

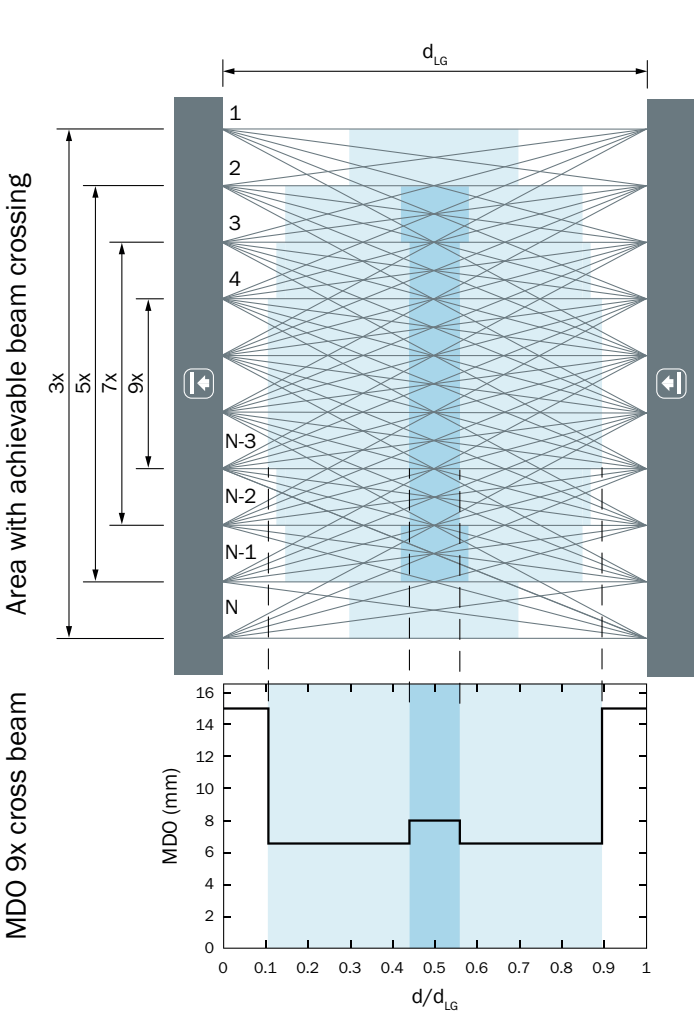

d_{LG} = Installed working distance between sender and receiver
 d = Distance to sender or receiver related to the installed working distance

Functional principle

Optical synchronization

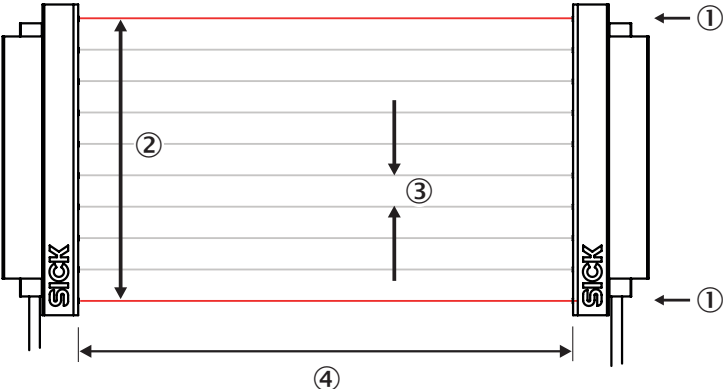







The transmitter and receiver synchronize optically, so no electrical connection is required. For this reason, either the first or the last beam of the automation light grid must remain unobstructed. If both beams are interrupted, measurement is no longer possible.

- ① Optical synchronization
- ② Detection height
- ③ Beam separation
- ④ Scanning range

Recommended accessories

Other models and accessories → www.sick.com/SLG-2

| | Brief description | Type | Part no. |
|---|---|--------------------|----------|
| Connection modules | | | |
|  | External, passive control unit with one pushbutton and three LEDs. Cable with male connector M12, 4-pin; cable material: PUR; housing material: plastic, TPU, reinforced; supply voltage: DC 10 V DC ... 30 V DC; current I _{max.} : 510 mA; protection class: III (EN 61140); EMC: EN 61000-6-2, EN 61000-6-4; ambient temperature operation: -25 °C ... +55 °C; ambient temperature storage: -25 °C ... +70 °C | ECU1-2121AAZZZ | 2118078 |
| Mounting brackets and plates | | | |
|  | 4 pieces, Mounting bracket for switching automation light grids, SLG-2 | BEF-SLG2-SET1 | 2111623 |
|  | <ul style="list-style-type: none"> • Connection type head A: Female connector, M12, 4-pin, straight, A-coded • Connection type head B: Flying leads • Signal type: Sensor/actuator cable • Cable: 5 m, 4-wire, PUR, halogen-free • Description: Sensor/actuator cable, unshielded • Application: Uncontaminated zones, Zones with oils and lubricants, Robot, Drag chain operation | YF2A14-050UB3XLEAX | 2095608 |
|  | <ul style="list-style-type: none"> • Connection type head A: Female connector, M12, 4-pin, straight, A-coded • Connection type head B: Male connector, M12, 4-pin, straight, A-coded • Signal type: Sensor/actuator cable • Cable: 5 m, 4-wire, PUR, halogen-free • Description: Sensor/actuator cable, unshielded • Application: Uncontaminated zones, Zones with oils and lubricants, Robot, Drag chain operation | YF2A14-050UB3M2A14 | 2096001 |
|  | <ul style="list-style-type: none"> • Connection type head A: Male connector, M12, 5-pin, A-coded • Connection type head B: Female connector, M12, 5-pin, A-coded • Connection type head C: Female connector, M12, 3-pin, A-coded • Signal type: Sensor/actuator cable • Description: Sensor/actuator cable • Application: Zones with oils and lubricants | YM2A15-000S01FY2A5 | 2099606 |
| Sensor Integration Gateway | | | |
|  | <ul style="list-style-type: none"> • Further functions: Web server integrated, IIoT interface available (dual talk) • Logic editor: no • Communication interface: IO-Link, Ethernet, PROFINET, REST API, MQTT, OPC UA • Product category: IO-Link Master | SIG350-0004AP100 | 6076871 |
| | <ul style="list-style-type: none"> • Further functions: Web server integrated, IIoT interface available (dual talk) • Logic editor: no • Communication interface: IO-Link, Ethernet, EtherNet/IP™, REST API, MQTT, OPC UA • Product category: IO-Link Master | SIG350-0005AP100 | 6076923 |
| | <ul style="list-style-type: none"> • Further functions: Web server integrated, IIoT interface available (dual talk) • Logic editor: no • Communication interface: IO-Link, Ethernet, EtherCAT®, REST API, MQTT, OPC UA • Product category: IO-Link Master | SIG350-0006AP100 | 6076924 |

SICK AT A GLANCE

SICK is one of the leading manufacturers of intelligent sensors and sensor solutions for industrial applications. A unique range of products and services creates the perfect basis for controlling processes securely and efficiently, protecting individuals from accidents and preventing damage to the environment.

We have extensive experience in a wide range of industries and understand their processes and requirements. With intelligent sensors, we can deliver exactly what our customers need. In application centers in Europe, Asia and North America, system solutions are tested and optimized in accordance with customer specifications. All this makes us a reliable supplier and development partner.

Comprehensive services complete our offering: SICK LifeTime Services provide support throughout the machine life cycle and ensure safety and productivity.

For us, that is “Sensor Intelligence.”

WORLDWIDE PRESENCE:

Contacts and other locations –www.sick.com