



SPZ-030-024-M

**SICK**  
Sensor Intelligence.



## Ordering information

Type	Part no.
SPZ-030-024-M	2123019

Other models and accessories → [www.sick.com/](http://www.sick.com/)

## Detailed technical data

### Technical specifications

<b>Accessory group</b>	Shaft adaptation
<b>Accessory family</b>	Collets and clamping rings
<b>Description</b>	Collet for through hollow shaft, shaft diameter 24 mm, external diameter 30 mm
<b>Shaft diameter</b>	24 mm

## Dimensional drawing (Dimensions in mm (inch))

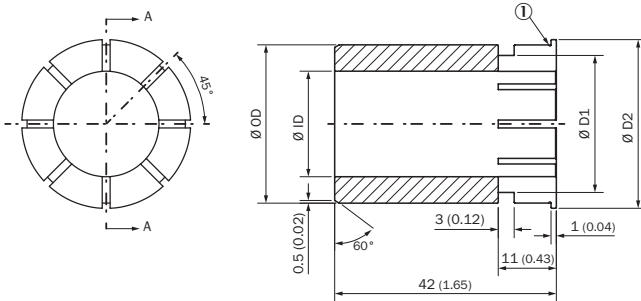

Type	Part number	ØOD	ØID	ØD1	ØD2
SPZ-030-028-M	2123021	30 mm	28 mm	30 mm	32 mm
SPZ-030-025-M	2123020		25 mm	30 mm	
SPZ-030-024-M	2123019		24 mm	30 mm	
SPZ-030-020-M	2123018		20 mm	26 mm	
SPZ-030-018-M	2123017		18 mm	24 mm	
SPZ-030-016-M	2123016		16 mm	22 mm	
SPZ-030-01Z-M	2123015		1"	30 mm	
SPZ-030-012Z-M	2142263		1/2"	19 mm	
SPZ-030-034Z-M	2123014		3/4"	25 mm	
SPZ-030-058Z-M	2123013		5/8"	22 mm	
SPZ-042-040-M	2123012	42 mm	40 mm	42 mm	44 mm
SPZ-042-038-M	2123011		38 mm	42 mm	
SPZ-042-035-M	2123010		35 mm	41 mm	
SPZ-042-032-M	2123009		32 mm	38 mm	

Type	Part number	ØOD	ØID	ØD1	ØD2
SPZ-042-030-M	2123008		30 mm	36 mm	
SPZ-042-118Z-M	2143603		1 1/8"	29 mm	

## SICK AT A GLANCE

SICK is one of the leading manufacturers of intelligent sensors and sensor solutions for industrial applications. A unique range of products and services creates the perfect basis for controlling processes securely and efficiently, protecting individuals from accidents and preventing damage to the environment.

We have extensive experience in a wide range of industries and understand their processes and requirements. With intelligent sensors, we can deliver exactly what our customers need. In application centers in Europe, Asia and North America, system solutions are tested and optimized in accordance with customer specifications. All this makes us a reliable supplier and development partner.

Comprehensive services complete our offering: SICK LifeTime Services provide support throughout the machine life cycle and ensure safety and productivity.

For us, that is “Sensor Intelligence.”

## WORLDWIDE PRESENCE:

Contacts and other locations –[www.sick.com](http://www.sick.com)