



TBS-1QSG12506NE

TBS

TEMPERATURE SENSORS

SICK
Sensor Intelligence.



Illustration may differ



Ordering information

Type	Part no.
TBS-1QSG12506NE	6061431

Other models and accessories → www.sick.com/TBS

Detailed technical data

Features

Temperature measuring range	-20 °C ... +80 °C
Sensor element	Pt1000, 2-wire, class A according to IEC 60751
Output signals	IO-Link/PNP + PNP + 4 mA ... 20 mA
Switching output	Transistor
Switching voltage	Supply voltage [V DC] - 1 V DC
Maximum switching current	≤ 250 mA
Switching delay	0 s ... 50 s, programmable
Setting accuracy of switching outputs	+0.1 °C
Switching output	Transistor
Number	2
Switching voltage	Supply voltage [V DC] - 1 V DC
Maximum switching current	≤ 250 mA
Switching delay	0 s ... 50 s, programmable
Setting accuracy of switching outputs	+0.1 °C
Temperature offset	± 3 °C
Scaling of measuring range	Zero point: max. +25 % of span Full scale: max. -25 % of span
Scaling of measuring range	Max. +25 % of span, max. -25 % of span
Display	14-segment LED, blue, 4-digits, height 9 mm, Display electronically turnable by 180 °, update: 200 ms
Rotatable housing	Display against housing with electrical connection: 330 ° Housing against process connection: 320 °

Mechanics/electronics

Process connection	Thread G ¼ A according to DIN 3852-E
---------------------------	--------------------------------------

¹⁾ At room temperature and when connected through thread.

²⁾ IP enclosure rating as per IEC 60529.

Insertion length/diameter of probe	250 mm / 6 mm
Seal	NBR
Wetted parts	Stainless steel 1.4571 (AISI 316Ti)
Maximum process pressure	≤ 150 bar ¹⁾
Housing material	Lower body: stainless steel 1.4301 (AISI 304) Plastic head: PC + ABS Input keypad: TPE-E Display window: PC
Connection type	Round connector M12 x 1, 5-pin
Enclosure rating	IP65 ²⁾ IP67 ²⁾
Maximum ohmic load R_A	≤ 100 kΩ (Switching outputs) < 0.5 kΩ (output signal 4 mA ... 20 mA)
Supply voltage	15 V DC ... 35 V DC
Maximum current consumption	70 mA
Total current consumption	570 mA (incl. switching current) 320 mA
Protection class	III
Isolation voltage	500 V DC
Overvoltage protection	40 V DC
Short-circuit protection	Outputs Q _A , Q ₁ , Q ₂ towards M
Reverse polarity protection	L ⁺ towards M
Electrical safety	
Protection class	III
Isolation voltage	500 V DC
Overvoltage protection	40 V DC
Short-circuit protection	Outputs Q _A , Q ₁ , Q ₂ towards M
Reverse polarity protection	L ⁺ towards M
CE-conformity	2004/108/EC, EN 61326-1 emission (group 1, class B) and interference immunity (industrial application)
RoHS certificate	✓
MTTF	283 years

¹⁾ At room temperature and when connected through thread.

²⁾ IP enclosure rating as per IEC 60529.

Performance

Accuracy of sensor element	≤ ± (0.15 °C + 0.002 t) ¹⁾
Accuracy of switching output	≤ ± 0.8 % of span
Display accuracy	≤ ± 0.8 % of span ± 1 digit
Accuracy of analog output	≤ ± 0.5 % of span
Response time t₅₀	≤ 5 s ²⁾
Response time t₉₀	≤ 10 s ²⁾

¹⁾ |t| is the absolute value of the temperature in °C.

²⁾ Depending on sensor configuration, according to IEC 60751.

Ambient data

Ambient temperature	-20 °C ... +80 °C
Storage and transport temperature	-20 °C ... +80 °C
Relative humidity	45 % ... 75 %

Classifications

ECLASS 5.0	27200208
ECLASS 5.1.4	27200208
ECLASS 6.0	27200208
ECLASS 6.2	27200208
ECLASS 7.0	27200208
ECLASS 8.0	27200208
ECLASS 8.1	27200208
ECLASS 9.0	27200208
ECLASS 10.0	27200208
ECLASS 11.0	27200208
ECLASS 12.0	27200208
ETIM 5.0	EC002994
ETIM 6.0	EC002994
ETIM 7.0	EC002994
ETIM 8.0	EC002994
UNSPSC 16.0901	41112211

Dimensional drawing (Dimensions in mm (inch))

TBS with connection G 1/4 A according to DIN 3852-E

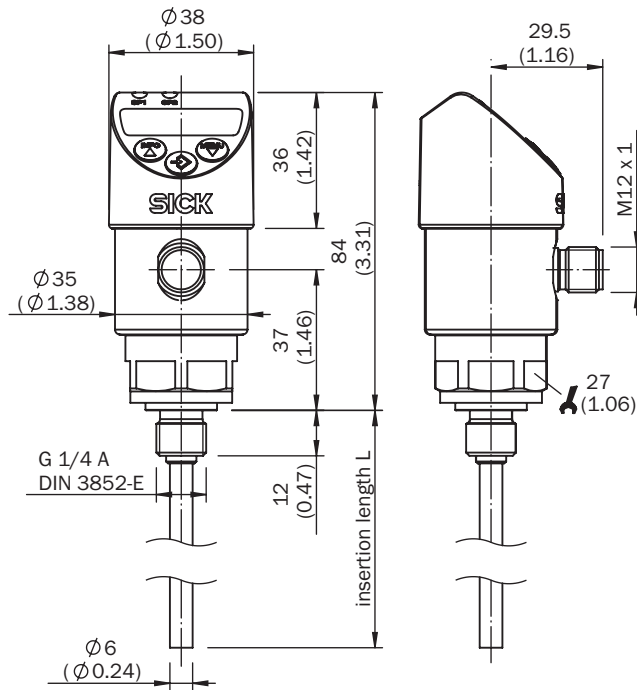

Connection type





- ① L+
- ② Q₂
- ③ M
- ④ Q₁
- ⑤ Q_A

Recommended accessories

Other models and accessories → www.sick.com/TBS

	Brief description	Type	Part no.
Others			
	<ul style="list-style-type: none"> • Connection type head A: Female connector, M12, 5-pin, straight, A-coded • Connection type head B: Flying leads • Signal type: Sensor/actuator cable • Cable: 2 m, 5-wire, PUR, halogen-free • Description: Sensor/actuator cable, unshielded • Application: Zones with oils and lubricants, Drag chain operation, Robot 	YF2A15-020UB5XLEAX	2095617

	Brief description	Type	Part no.
	<ul style="list-style-type: none"> • Connection type head A: Female connector, M12, 5-pin, straight, A-coded • Connection type head B: Flying leads • Signal type: Sensor/actuator cable • Cable: 5 m, 5-wire, PUR, halogen-free • Description: Sensor/actuator cable, unshielded • Application: Zones with oils and lubricants, Drag chain operation, Robot 	YF2A15-050UB5XLEAX	2095618
	<ul style="list-style-type: none"> • Connection type head A: Female connector, M12, 5-pin, straight, A-coded • Connection type head B: Flying leads • Signal type: Sensor/actuator cable • Cable: 2 m, 5-wire, PVC • Description: Sensor/actuator cable, unshielded • Application: Zones with chemicals 	YF2A15-020VB5XLEAX	2096239
	<ul style="list-style-type: none"> • Connection type head A: Female connector, M12, 5-pin, straight, A-coded • Connection type head B: Flying leads • Signal type: Sensor/actuator cable • Cable: 5 m, 5-wire, PVC • Description: Sensor/actuator cable, unshielded • Application: Zones with chemicals 	YF2A15-050VB5XLEAX	2096240

Recommended services

Additional services → www.sick.com/TBS

	Type	Part no.
Function Block Factory		
<ul style="list-style-type: none"> • Description: The Function Block Factory supports common programmable logic controllers (PLCs) from various manufacturers, such as Siemens, Beckhoff, Rockwell Automation and B&R. More information on the FBF can be found <a _blank"="" href="https://fbf.cloud.sick.com target=">here. • Note: You can configure your function block at <a _blank"="" href="https://fbf.cloud.sick.com target=">Function Block Factory. As a login please use your SICK ID. 	Function Block Factory	On request

SICK AT A GLANCE

SICK is one of the leading manufacturers of intelligent sensors and sensor solutions for industrial applications. A unique range of products and services creates the perfect basis for controlling processes securely and efficiently, protecting individuals from accidents and preventing damage to the environment.

We have extensive experience in a wide range of industries and understand their processes and requirements. With intelligent sensors, we can deliver exactly what our customers need. In application centers in Europe, Asia and North America, system solutions are tested and optimized in accordance with customer specifications. All this makes us a reliable supplier and development partner.

Comprehensive services complete our offering: SICK LifeTime Services provide support throughout the machine life cycle and ensure safety and productivity.

For us, that is “Sensor Intelligence.”

WORLDWIDE PRESENCE:

Contacts and other locations –www.sick.com