



THTS-1ABD20506MZ

THTS

TEMPERATURE SENSORS

SICK
Sensor Intelligence.



Illustration may differ



Ordering information

Type	Part no.
THTS-1ABD20506MZ	6047726

Other models and accessories → www.sick.com/THTS

Detailed technical data

Features

Measuring range	-50 °C ... +250 °C
Sensor element	Pt1000
Output signal	4 mA ... 20 mA, 2-wire
Maximum ohmic load R_A	$R_A \leq (L^+ - 10 \text{ V}) / 0.023 \text{ A}$ [Ohm]

Mechanics/electronics

Process connection	Clamp (DIN 32676) DN 10, DN 15, DN 20
Insertion length/diameter of probe	50 mm / 6 mm
Wetted parts	Stainless steel 1.4435 / 316L, $R_a \leq 0.8 \mu\text{m}$
Pressure resistance	Max. 16 bar at room temperature
Housing material	Stainless steel (CrNi)
Connection type	M12 round connector x 1, 4-pin ¹⁾
Enclosure rating	IP67 ²⁾ IP69 ²⁾
Supply voltage	10 V DC ... 35 V DC
Maximum current consumption	Ca. 30 mA
Electrical safety	Protection class: III, dielectric strength: 500 V AC, Reverse polarity protection: L ⁺ to M
Protection class III	✓
CE-conformity	2004/108/EC, EN 61326-2-3
RoHS certificate	✓
Initialization time	Max. 4 s

¹⁾ The enclosure rating classes specified only apply while the thermometer is connected with female connectors that provide the corresponding enclosure rating.

²⁾ IP enclosure rating as per IEC 60529.

Performance

Accuracy of sensor element	Class A according to IEC 60751 ¹⁾
Transmitter accuracy	± 0,25 K

¹⁾ Class B (measuring range -50 °C ... -30 °C).

²⁾ Depending on sensor configuration, according to IEC 60751.

Transmitter linearity	$\leq \pm 0.1 \% \text{ of span}$
Response time	$t_{50} \leq 3,3 \text{ s}$ $t_{90} \leq 9,7 \text{ s}^{2)}$

¹⁾ Class B (measuring range $-50 \text{ }^\circ\text{C} \dots -30 \text{ }^\circ\text{C}$).

²⁾ Depending on sensor configuration, according to IEC 60751.

Ambient data

Ambient temperature	$-40 \text{ }^\circ\text{C} \dots +85 \text{ }^\circ\text{C}$
Storage and transport temperature	$-40 \text{ }^\circ\text{C} \dots +85 \text{ }^\circ\text{C}$
Shock resistance	50 g, 6ms (according to IEC 60068-2-27)
Relative humidity	100 % ¹⁾

¹⁾ , Condensation allowed.

Classifications

ECLASS 5.0	27200208
ECLASS 5.1.4	27200208
ECLASS 6.0	27200208
ECLASS 6.2	27200208
ECLASS 7.0	27200208
ECLASS 8.0	27200208
ECLASS 8.1	27200208
ECLASS 9.0	27200208
ECLASS 10.0	27200208
ECLASS 11.0	27200208
ECLASS 12.0	27200208
ETIM 5.0	EC002994
ETIM 6.0	EC002994
ETIM 7.0	EC002994
ETIM 8.0	EC002994
UNSPSC 16.0901	41112211

Dimensional drawing (Dimensions in mm (inch))

Dimensional drawing

Pt100, 4 mA...20 mA,
up to 150 °C

Pt100, 4 mA...20 mA,
up to 250 °C

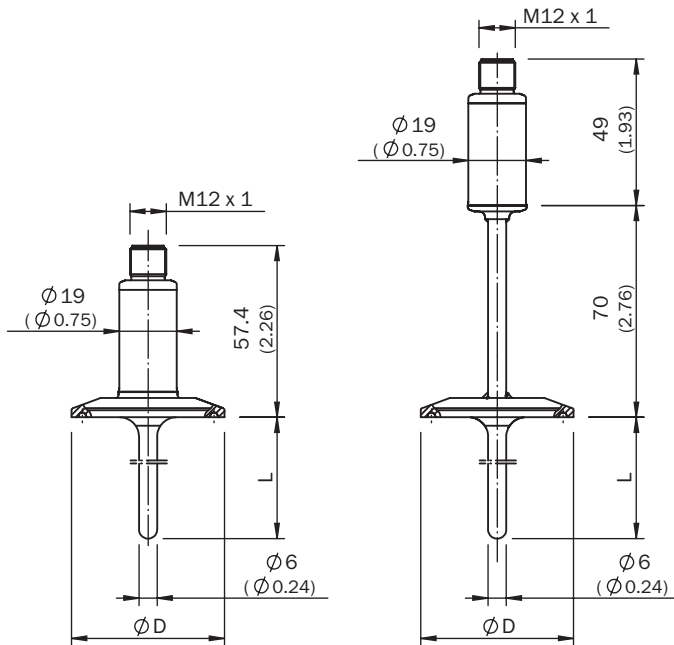

All dimensions in mm (inch)

Design		Ø D
DIN 32676	DN 10 ... DN 20	34.0 (1.34)
	DN 25 ... DN 40	50.5 (1.99)
	DN 50	64.0 (2.52)
ISO 2852	DN 12 ... DN 21.3	34.0 (1.34)
	DN 25 ... DN 38	50.5 (1.99)
	DN 40, DN 51	64.0 (2.52)
Tri-Clamp	1", 1 1/2"	50.5 (1.99)
	2"	64.0 (2.52)

Application





Connection type

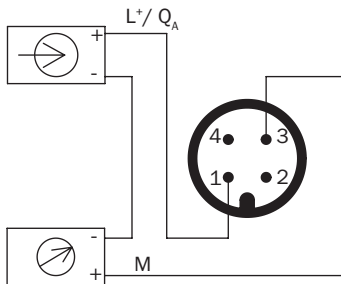







Plug M12 x 1, output signal 4 mA ... 20 mA



Recommended accessories

Other models and accessories → www.sick.com/THTS

	Brief description	Type	Part no.
Others			
	<ul style="list-style-type: none"> • Connection type head A: Female connector, M12, 4-pin, straight, A-coded • Connection type head B: Flying leads • Signal type: Sensor/actuator cable • Cable: 2 m, 4-wire, PUR, halogen-free • Description: Sensor/actuator cable, unshielded • Application: Zones with oils and lubricants, Drag chain operation, Robot 	YF2A14-020UB3XLEAX	2095607
	<ul style="list-style-type: none"> • Connection type head A: Female connector, M12, 4-pin, straight, A-coded • Connection type head B: Flying leads • Signal type: Sensor/actuator cable • Cable: 5 m, 4-wire, PUR, halogen-free • Description: Sensor/actuator cable, unshielded • Application: Zones with oils and lubricants, Drag chain operation, Robot 	YF2A14-050UB3XLEAX	2095608
	<ul style="list-style-type: none"> • Connection type head A: Female connector, M12, 4-pin, straight, A-coded • Connection type head B: Flying leads • Signal type: Sensor/actuator cable • Cable: 10 m, 4-wire, PUR, halogen-free • Description: Sensor/actuator cable, unshielded • Application: Zones with oils and lubricants, Drag chain operation, Robot 	YF2A14-100UB3XLEAX	2095609

	Brief description	Type	Part no.
	<ul style="list-style-type: none"> • Connection type head A: Female connector, M12, 4-pin, angled, A-coded • Connection type head B: Flying leads • Signal type: Sensor/actuator cable • Cable: 2 m, 4-wire, PUR, halogen-free • Description: Sensor/actuator cable, unshielded • Application: Zones with oils and lubricants, Drag chain operation, Robot 	YG2A14-020UB3XLEAX	2095766
	<ul style="list-style-type: none"> • Connection type head A: Female connector, M12, 4-pin, angled, A-coded • Connection type head B: Flying leads • Signal type: Sensor/actuator cable • Cable: 5 m, 4-wire, PUR, halogen-free • Description: Sensor/actuator cable, unshielded • Application: Zones with oils and lubricants, Drag chain operation, Robot 	YG2A14-050UB3XLEAX	2095767
	<ul style="list-style-type: none"> • Connection type head A: Female connector, M12, 4-pin, angled, A-coded • Connection type head B: Flying leads • Signal type: Sensor/actuator cable • Cable: 10 m, 4-wire, PUR, halogen-free • Description: Sensor/actuator cable, unshielded • Application: Zones with oils and lubricants, Drag chain operation, Robot 	YG2A14-100UB3XLEAX	2095768
	<ul style="list-style-type: none"> • Connection type head A: Female connector, M12, 4-pin, straight, A-coded • Connection type head B: Flying leads • Signal type: Sensor/actuator cable • Cable: 2 m, 4-wire, PVC • Description: Sensor/actuator cable, unshielded • Application: Zones with chemicals 	YF2A14-020VB3XLEAX	2096234
	<ul style="list-style-type: none"> • Connection type head A: Female connector, M12, 4-pin, straight, A-coded • Connection type head B: Flying leads • Signal type: Sensor/actuator cable • Cable: 5 m, 4-wire, PVC • Description: Sensor/actuator cable, unshielded • Application: Zones with chemicals 	YF2A14-050VB3XLEAX	2096235
	<ul style="list-style-type: none"> • Connection type head A: Female connector, M12, 4-pin, straight, A-coded • Connection type head B: Flying leads • Signal type: Sensor/actuator cable • Cable: 10 m, 4-wire, PVC • Description: Sensor/actuator cable, unshielded • Application: Zones with chemicals 	YF2A14-100VB3XLEAX	2096236
	<ul style="list-style-type: none"> • Connection type head A: Female connector, M12, 4-pin, straight, A-coded • Connection type head B: Flying leads • Signal type: Sensor/actuator cable • Cable: 15 m, 4-wire, PVC • Description: Sensor/actuator cable, unshielded • Application: Zones with chemicals 	YF2A14-150VB3XLEAX	2096237
	<ul style="list-style-type: none"> • Connection type head A: Female connector, M12, 4-pin, angled, A-coded • Connection type head B: Flying leads • Signal type: Sensor/actuator cable • Cable: 2 m, 4-wire, PVC • Description: Sensor/actuator cable, unshielded • Application: Zones with chemicals 	YG2A14-020VB3XLEAX	2095895
	<ul style="list-style-type: none"> • Connection type head A: Female connector, M12, 4-pin, angled, A-coded • Connection type head B: Flying leads • Signal type: Sensor/actuator cable • Cable: 5 m, 4-wire, PVC • Description: Sensor/actuator cable, unshielded • Application: Zones with chemicals 	YG2A14-050VB3XLEAX	2095897
	<ul style="list-style-type: none"> • Connection type head A: Female connector, M12, 4-pin, angled, A-coded • Connection type head B: Flying leads • Signal type: Sensor/actuator cable • Cable: 10 m, 4-wire, PVC • Description: Sensor/actuator cable, unshielded • Application: Zones with chemicals 	YG2A14-100VB3XLEAX	2095898

SICK AT A GLANCE

SICK is one of the leading manufacturers of intelligent sensors and sensor solutions for industrial applications. A unique range of products and services creates the perfect basis for controlling processes securely and efficiently, protecting individuals from accidents and preventing damage to the environment.

We have extensive experience in a wide range of industries and understand their processes and requirements. With intelligent sensors, we can deliver exactly what our customers need. In application centers in Europe, Asia and North America, system solutions are tested and optimized in accordance with customer specifications. All this makes us a reliable supplier and development partner.

Comprehensive services complete our offering: SICK LifeTime Services provide support throughout the machine life cycle and ensure safety and productivity.

For us, that is “Sensor Intelligence.”

WORLDWIDE PRESENCE:

Contacts and other locations –www.sick.com