



# THTS-1PAC20506MZ

THTS

TEMPERATURE SENSORS

**SICK**  
Sensor Intelligence.



Illustration may differ



### Ordering information

| Type             | Part no. |
|------------------|----------|
| THTS-1PAC20506MZ | 6047680  |

Other models and accessories → [www.sick.com/THTS](http://www.sick.com/THTS)

### Detailed technical data

#### Features

|                        |                    |
|------------------------|--------------------|
| <b>Measuring range</b> | -50 °C ... +150 °C |
| <b>Sensor element</b>  | Pt100              |
| <b>Output signal</b>   | Pt100, 4-wire      |

#### Mechanics/electronics

|   |   |
|---|---|
| <b>Process connection</b>                 | Clamp (ISO 2852) DN 12, DN 12.7, DN 17.2, DN 21.3         |
| <b>Insertion length/diameter of probe</b> | 50 mm / 6 mm  |
| <b>Wetted parts</b>                       | Stainless steel 1.4435 / 316L, $R_a \leq 0.8 \mu\text{m}$ |
| <b>Pressure resistance</b>                | Max. 16 bar at room temperature                           |
| <b>Housing material</b>                   | Stainless steel (CrNi)                                    |
| <b>Connection type</b>                    | M12 round connector x 1, 4-pin <sup>1)</sup>              |
| <b>Enclosure rating</b>                   | IP67 <sup>2)</sup><br>IP69 <sup>2)</sup>                  |
| <b>Measuring current</b>                  | 0.1 mA ... 1 mA   |
| <b>Electrical safety</b>                  | Protection class: III, dielectric strength: 500 V AC      |
| <b>Protection class III</b>               | ✓   |
| <b>RoHS certificate</b>                   | ✓   |
| <b>Initialization time</b>                | Max. 4 s  |

<sup>1)</sup> The enclosure rating classes specified only apply while the thermometer is connected with female connectors that provide the corresponding enclosure rating.

<sup>2)</sup> IP enclosure rating as per IEC 60529.

#### Performance

|                                   |   |
|-----------------------------------|---|
| <b>Accuracy of sensor element</b> | Class A according to IEC 60751 <sup>1)</sup>                              |
| <b>Transmitter accuracy</b>       | $\pm 0,25 \text{ K}$  |
| <b>Transmitter linearity</b>      | $\leq \pm 0.1 \% \text{ of span}$   |
| <b>Response time</b>              | $t_{50} \leq 3,3 \text{ s}$<br>$t_{90} \leq 9,7 \text{ s} \text{ } ^{2)}$ |

<sup>1)</sup> Class B (measuring range -50 °C ... -30 °C).

<sup>2)</sup> Depending on sensor configuration, according to IEC 60751.

## Ambient data

|  |   |
|--|---|
| <b>Ambient temperature</b>               | -40 °C ... +85 °C                       |
| <b>Storage and transport temperature</b> | -40 °C ... +85 °C                       |
| <b>Shock resistance</b>                  | 50 g, 6ms (according to IEC 60068-2-27) |
| <b>Relative humidity</b>                 | 100 % <sup>1)</sup>                     |

<sup>1)</sup> , Condensation allowed.

## Classifications

|                       |          |
|-----------------------|----------|
| <b>ECLASS 5.0</b>     | 27200208 |
| <b>ECLASS 5.1.4</b>   | 27200208 |
| <b>ECLASS 6.0</b>     | 27200208 |
| <b>ECLASS 6.2</b>     | 27200208 |
| <b>ECLASS 7.0</b>     | 27200208 |
| <b>ECLASS 8.0</b>     | 27200208 |
| <b>ECLASS 8.1</b>     | 27200208 |
| <b>ECLASS 9.0</b>     | 27200208 |
| <b>ECLASS 10.0</b>    | 27200208 |
| <b>ECLASS 11.0</b>    | 27200208 |
| <b>ECLASS 12.0</b>    | 27200208 |
| <b>ETIM 5.0</b>       | EC002994 |
| <b>ETIM 6.0</b>       | EC002994 |
| <b>ETIM 7.0</b>       | EC002994 |
| <b>ETIM 8.0</b>       | EC002994 |
| <b>UNSPSC 16.0901</b> | 41112211 |

Dimensional drawing (Dimensions in mm (inch))

Dimensional drawing

Pt100, 4 mA...20 mA,  
up to 150 °C

Pt100, 4 mA...20 mA,  
up to 250 °C

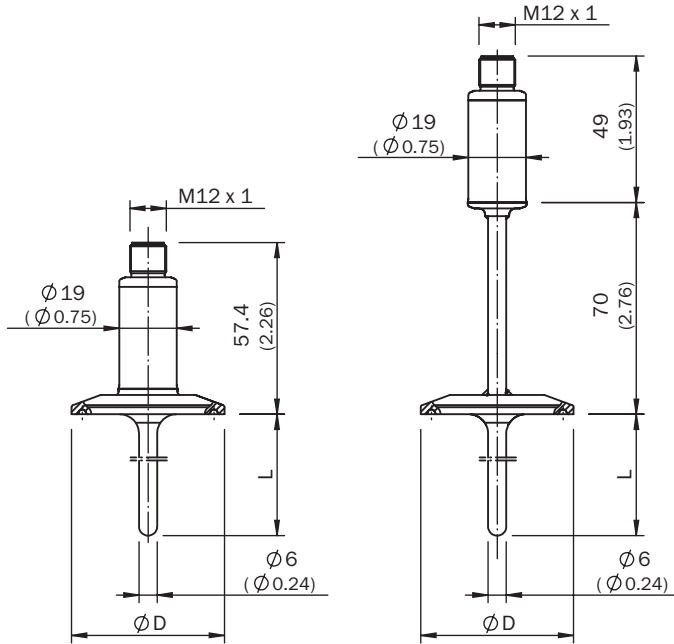

All dimensions in mm (inch)

| Design           |                   | Ø D         |
|------------------|-------------------|-------------|
| <b>DIN 32676</b> | DN 10 ... DN 20   | 34.0 (1.34) |
|                  | DN 25 ... DN 40   | 50.5 (1.99) |
|                  | DN 50             | 64.0 (2.52) |
| <b>ISO 2852</b>  | DN 12 ... DN 21.3 | 34.0 (1.34) |
|                  | DN 25 ... DN 38   | 50.5 (1.99) |
|                  | DN 40, DN 51      | 64.0 (2.52) |
| <b>Tri-Clamp</b> | 1", 1 ½"          | 50.5 (1.99) |
|                  | 2"                | 64.0 (2.52) |

## Application





## Connection type

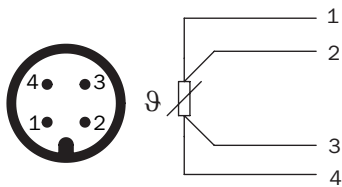

Round connector M12 x 1, output signal Pt100



## Recommended accessories

Other models and accessories → [www.sick.com/THTS](http://www.sick.com/THTS)

|   | Brief description   | Type               | Part no. |
|---|---|--------------------|----------|
| Others  |   |                    |          |
|  | <ul style="list-style-type: none"> <li><b>Connection type head A:</b> Female connector, M12, 4-pin, straight, A-coded</li> <li><b>Connection type head B:</b> Flying leads</li> <li><b>Signal type:</b> Sensor/actuator cable</li> <li><b>Cable:</b> 2 m, 4-wire, PUR, halogen-free</li> <li><b>Description:</b> Sensor/actuator cable, unshielded</li> <li><b>Application:</b> Zones with oils and lubricants, Drag chain operation, Robot</li> </ul>  | YF2A14-020UB3XLEAX | 2095607  |
|  | <ul style="list-style-type: none"> <li><b>Connection type head A:</b> Female connector, M12, 4-pin, straight, A-coded</li> <li><b>Connection type head B:</b> Flying leads</li> <li><b>Signal type:</b> Sensor/actuator cable</li> <li><b>Cable:</b> 5 m, 4-wire, PUR, halogen-free</li> <li><b>Description:</b> Sensor/actuator cable, unshielded</li> <li><b>Application:</b> Zones with oils and lubricants, Drag chain operation, Robot</li> </ul>  | YF2A14-050UB3XLEAX | 2095608  |
|  | <ul style="list-style-type: none"> <li><b>Connection type head A:</b> Female connector, M12, 4-pin, straight, A-coded</li> <li><b>Connection type head B:</b> Flying leads</li> <li><b>Signal type:</b> Sensor/actuator cable</li> <li><b>Cable:</b> 10 m, 4-wire, PUR, halogen-free</li> <li><b>Description:</b> Sensor/actuator cable, unshielded</li> <li><b>Application:</b> Zones with oils and lubricants, Drag chain operation, Robot</li> </ul> | YF2A14-100UB3XLEAX | 2095609  |

|   | Brief description   | Type               | Part no. |
|---|---|--------------------|----------|
|    | <ul style="list-style-type: none"> <li>• <b>Connection type head A:</b> Female connector, M12, 4-pin, angled, A-coded</li> <li>• <b>Connection type head B:</b> Flying leads</li> <li>• <b>Signal type:</b> Sensor/actuator cable</li> <li>• <b>Cable:</b> 2 m, 4-wire, PUR, halogen-free</li> <li>• <b>Description:</b> Sensor/actuator cable, unshielded</li> <li>• <b>Application:</b> Zones with oils and lubricants, Drag chain operation, Robot</li> </ul>  | YG2A14-020UB3XLEAX | 2095766  |
|    | <ul style="list-style-type: none"> <li>• <b>Connection type head A:</b> Female connector, M12, 4-pin, angled, A-coded</li> <li>• <b>Connection type head B:</b> Flying leads</li> <li>• <b>Signal type:</b> Sensor/actuator cable</li> <li>• <b>Cable:</b> 5 m, 4-wire, PUR, halogen-free</li> <li>• <b>Description:</b> Sensor/actuator cable, unshielded</li> <li>• <b>Application:</b> Zones with oils and lubricants, Drag chain operation, Robot</li> </ul>  | YG2A14-050UB3XLEAX | 2095767  |
|    | <ul style="list-style-type: none"> <li>• <b>Connection type head A:</b> Female connector, M12, 4-pin, angled, A-coded</li> <li>• <b>Connection type head B:</b> Flying leads</li> <li>• <b>Signal type:</b> Sensor/actuator cable</li> <li>• <b>Cable:</b> 10 m, 4-wire, PUR, halogen-free</li> <li>• <b>Description:</b> Sensor/actuator cable, unshielded</li> <li>• <b>Application:</b> Zones with oils and lubricants, Drag chain operation, Robot</li> </ul> | YG2A14-100UB3XLEAX | 2095768  |
|    | <ul style="list-style-type: none"> <li>• <b>Connection type head A:</b> Female connector, M12, 4-pin, straight, A-coded</li> <li>• <b>Connection type head B:</b> Flying leads</li> <li>• <b>Signal type:</b> Sensor/actuator cable</li> <li>• <b>Cable:</b> 2 m, 4-wire, PVC</li> <li>• <b>Description:</b> Sensor/actuator cable, unshielded</li> <li>• <b>Application:</b> Zones with chemicals</li> </ul>   | YF2A14-020VB3XLEAX | 2096234  |
|    | <ul style="list-style-type: none"> <li>• <b>Connection type head A:</b> Female connector, M12, 4-pin, straight, A-coded</li> <li>• <b>Connection type head B:</b> Flying leads</li> <li>• <b>Signal type:</b> Sensor/actuator cable</li> <li>• <b>Cable:</b> 5 m, 4-wire, PVC</li> <li>• <b>Description:</b> Sensor/actuator cable, unshielded</li> <li>• <b>Application:</b> Zones with chemicals</li> </ul>   | YF2A14-050VB3XLEAX | 2096235  |
|  | <ul style="list-style-type: none"> <li>• <b>Connection type head A:</b> Female connector, M12, 4-pin, straight, A-coded</li> <li>• <b>Connection type head B:</b> Flying leads</li> <li>• <b>Signal type:</b> Sensor/actuator cable</li> <li>• <b>Cable:</b> 10 m, 4-wire, PVC</li> <li>• <b>Description:</b> Sensor/actuator cable, unshielded</li> <li>• <b>Application:</b> Zones with chemicals</li> </ul>  | YF2A14-100VB3XLEAX | 2096236  |
|  | <ul style="list-style-type: none"> <li>• <b>Connection type head A:</b> Female connector, M12, 4-pin, straight, A-coded</li> <li>• <b>Connection type head B:</b> Flying leads</li> <li>• <b>Signal type:</b> Sensor/actuator cable</li> <li>• <b>Cable:</b> 15 m, 4-wire, PVC</li> <li>• <b>Description:</b> Sensor/actuator cable, unshielded</li> <li>• <b>Application:</b> Zones with chemicals</li> </ul>  | YF2A14-150VB3XLEAX | 2096237  |
|  | <ul style="list-style-type: none"> <li>• <b>Connection type head A:</b> Female connector, M12, 4-pin, angled, A-coded</li> <li>• <b>Connection type head B:</b> Flying leads</li> <li>• <b>Signal type:</b> Sensor/actuator cable</li> <li>• <b>Cable:</b> 2 m, 4-wire, PVC</li> <li>• <b>Description:</b> Sensor/actuator cable, unshielded</li> <li>• <b>Application:</b> Zones with chemicals</li> </ul>   | YG2A14-020VB3XLEAX | 2095895  |
|  | <ul style="list-style-type: none"> <li>• <b>Connection type head A:</b> Female connector, M12, 4-pin, angled, A-coded</li> <li>• <b>Connection type head B:</b> Flying leads</li> <li>• <b>Signal type:</b> Sensor/actuator cable</li> <li>• <b>Cable:</b> 5 m, 4-wire, PVC</li> <li>• <b>Description:</b> Sensor/actuator cable, unshielded</li> <li>• <b>Application:</b> Zones with chemicals</li> </ul>   | YG2A14-050VB3XLEAX | 2095897  |
|  | <ul style="list-style-type: none"> <li>• <b>Connection type head A:</b> Female connector, M12, 4-pin, angled, A-coded</li> <li>• <b>Connection type head B:</b> Flying leads</li> <li>• <b>Signal type:</b> Sensor/actuator cable</li> <li>• <b>Cable:</b> 10 m, 4-wire, PVC</li> <li>• <b>Description:</b> Sensor/actuator cable, unshielded</li> <li>• <b>Application:</b> Zones with chemicals</li> </ul>  | YG2A14-100VB3XLEAX | 2095898  |

## SICK AT A GLANCE

SICK is one of the leading manufacturers of intelligent sensors and sensor solutions for industrial applications. A unique range of products and services creates the perfect basis for controlling processes securely and efficiently, protecting individuals from accidents and preventing damage to the environment.

We have extensive experience in a wide range of industries and understand their processes and requirements. With intelligent sensors, we can deliver exactly what our customers need. In application centers in Europe, Asia and North America, system solutions are tested and optimized in accordance with customer specifications. All this makes us a reliable supplier and development partner.

Comprehensive services complete our offering: SICK LifeTime Services provide support throughout the machine life cycle and ensure safety and productivity.

For us, that is “Sensor Intelligence.”

## WORLDWIDE PRESENCE:

Contacts and other locations –[www.sick.com](http://www.sick.com)