



# TIM351-2134001S02

TiM

2D LIDAR SENSORS

**SICK**  
Sensor Intelligence.



### Ordering information

Type	Part no.
TIM351-2134001S02	1080181

Other models and accessories → [www.sick.com/TiM](http://www.sick.com/TiM)



### Detailed technical data

#### Features

<b>Application</b>	Outdoor, Indoor
<b>Measurement principle</b>	HDDM <sup>+</sup>
<b>Light source</b>	Infrared (850 nm)
<b>Laser class</b>	1 (IEC 60825-1:2014, EN 60825-1:2014)
<b>Aperture angle</b>	Horizontal 270°
<b>Scanning frequency</b>	15 Hz
<b>Angular resolution</b>	Horizontal 1°
<b>Working range</b>	0.05 m ... 10 m
<b>Scanning range</b>	At 10% remission factor 8 m

#### Mechanics/electronics

<b>Connection type</b>	1 x "Ethernet" connection, 4-pin M12 female connector 1 x connection "Power", 12-pin, M12 male connector 1 x Micro USB female connector, type B
<b>Supply voltage</b>	9 V DC ... 28 V DC
<b>Power consumption</b>	Typ. 4 W, 16 W with 4 max. loaded digital outputs
<b>Output current</b>	≤ 100 mA
<b>Housing color</b>	Gray (RAL 7032)
<b>Enclosure rating</b>	IP67, applies only when the plastic cover of the "Aux interface" is closed (IEC 60529:1989+AMD1:1999+AMD2:2013)
<b>Protection class</b>	III (IEC 61140:2016-1)
<b>Weight</b>	250 g, without connecting cables
<b>Dimensions (L x W x H)</b>	60 mm x 60 mm x 86 mm
<b>MTBF</b>	> 100 years

## Safety-related parameters

<b>MTTF<sub>D</sub></b>	100 years
-------------------------	-----------

## Performance

<b>Response time</b>	1 scan, typ. 67 ms 2 scans, ≤ 134 ms <sup>1)</sup>
<b>Detectable object shape</b>	Almost any
<b>Systematic error</b>	± 60 mm <sup>2)</sup>
<b>Statistical error</b>	< 20 mm <sup>2)</sup>
<b>Integrated application</b>	Field evaluation
<b>Number of field sets</b>	16 field triples (48 fields, contour as reference; 1 triple (3 flexible fields) can be configured directly at the scanner)
<b>Simultaneous evaluation cases</b>	1 (3 fields) 2 (2 fields for detection and 1 field for contour as reference)

<sup>1)</sup> At +45° to +225° of the working range; max. 150 ms at -45° to +45° of the working range.

<sup>2)</sup> Typical value at 90% remission up to maximum scanning range; real value depends on ambient conditions.

## Interfaces

<b>Ethernet</b>	✓, TCP/IP
Function	Service interface, parameterization
<b>USB</b>	✓
Remark	Micro USB
Function	Service interface, parameterization
<b>Digital inputs</b>	4
<b>Digital outputs</b>	3 (NPN, additional 1 x "Device Ready")
<b>Delay time</b>	67 ms ... 30,000 ms (configurable)
<b>Dwell time</b>	67 ms ... 600,052 ms (configurable)
<b>Optical indicators</b>	2 LEDs (ON, switching status)

## Ambient data

<b>Object remission</b>	4 % ... 1,000 % (reflectors)
<b>Electromagnetic compatibility (EMC)</b>	
Emitted radiation	Residential area (EN 61000-6-3:2007+AMD:A1:2011)
Electromagnetic immunity	Industrial environment (EN 61000-6-2:2005)
<b>Vibration resistance</b>	
Sine resonance scan	10 Hz ... 1,000 Hz <sup>1)</sup>
Sine test	10 Hz ... 500 Hz, 5 g, 10 frequency cycles <sup>1)</sup>
Noise test	10 Hz ... 250 Hz, 4.24 g RMS, 5 h <sup>2)</sup>
<b>Shock resistance</b>	
	50 g, 11 ms, ± 3 single shocks/axis <sup>3)</sup>
	25 g, 6 ms, ± 1,000 continuous shocks/axis <sup>3)</sup>

<sup>1)</sup> IEC 60068-2-6:2007.

<sup>2)</sup> IEC 60068-2-64:2008.

<sup>3)</sup> IEC 60068-2-27:2008.

<sup>4)</sup> IEC 60068-2-14:2009.

<sup>5)</sup> EN 60068-2-14:2009.

<sup>6)</sup> EN 60068-2-30:2005.

		50 g, 3 ms, ± 5,000 continuous shocks/axis <sup>3)</sup>
<b>Ambient operating temperature</b>		-25 °C ... +50 °C <sup>4)</sup>
<b>Storage temperature</b>		-40 °C ... +75 °C <sup>4)</sup>
<b>Switch-on temperature</b>		-10 °C ... +50 °C
<b>Temperature change</b>		-25 °C ... +50 °C, 10 cycles <sup>5)</sup>
<b>Damp heat</b>		+25 °C ... +55 °C, 95 % RH, 6 cycles <sup>6)</sup>
<b>Permissible relative humidity</b>	Operation	< 80 %, Non-condensing (EN 60068-2-30:2005)
	Storage	≤ 90 %, Non-condensing (EN 60068-2-30:2005)
<b>Ambient light immunity</b>		80,000 lx

<sup>1)</sup> IEC 60068-2-6:2007.

<sup>2)</sup> IEC 60068-2-64:2008.

<sup>3)</sup> IEC 60068-2-27:2008.

<sup>4)</sup> IEC 60068-2-14:2009.

<sup>5)</sup> EN 60068-2-14:2009.

<sup>6)</sup> EN 60068-2-30:2005.

### General notes

<b>Note on use</b>	The sensor does not constitute a safety component as defined by relevant legislation on machine safety.
--------------------	---

### Classifications

<b>ECLASS 5.0</b>	27270990
<b>ECLASS 5.1.4</b>	27270990
<b>ECLASS 6.0</b>	27270913
<b>ECLASS 6.2</b>	27270913
<b>ECLASS 7.0</b>	27270913
<b>ECLASS 8.0</b>	27270913
<b>ECLASS 8.1</b>	27270913
<b>ECLASS 9.0</b>	27270913
<b>ECLASS 10.0</b>	27270913
<b>ECLASS 11.0</b>	27270913
<b>ECLASS 12.0</b>	27270913
<b>ETIM 5.0</b>	EC002550
<b>ETIM 6.0</b>	EC002550
<b>ETIM 7.0</b>	EC002550
<b>ETIM 8.0</b>	EC002550
<b>UNSPSC 16.0901</b>	41111615

Dimensional drawing (Dimensions in mm (inch))

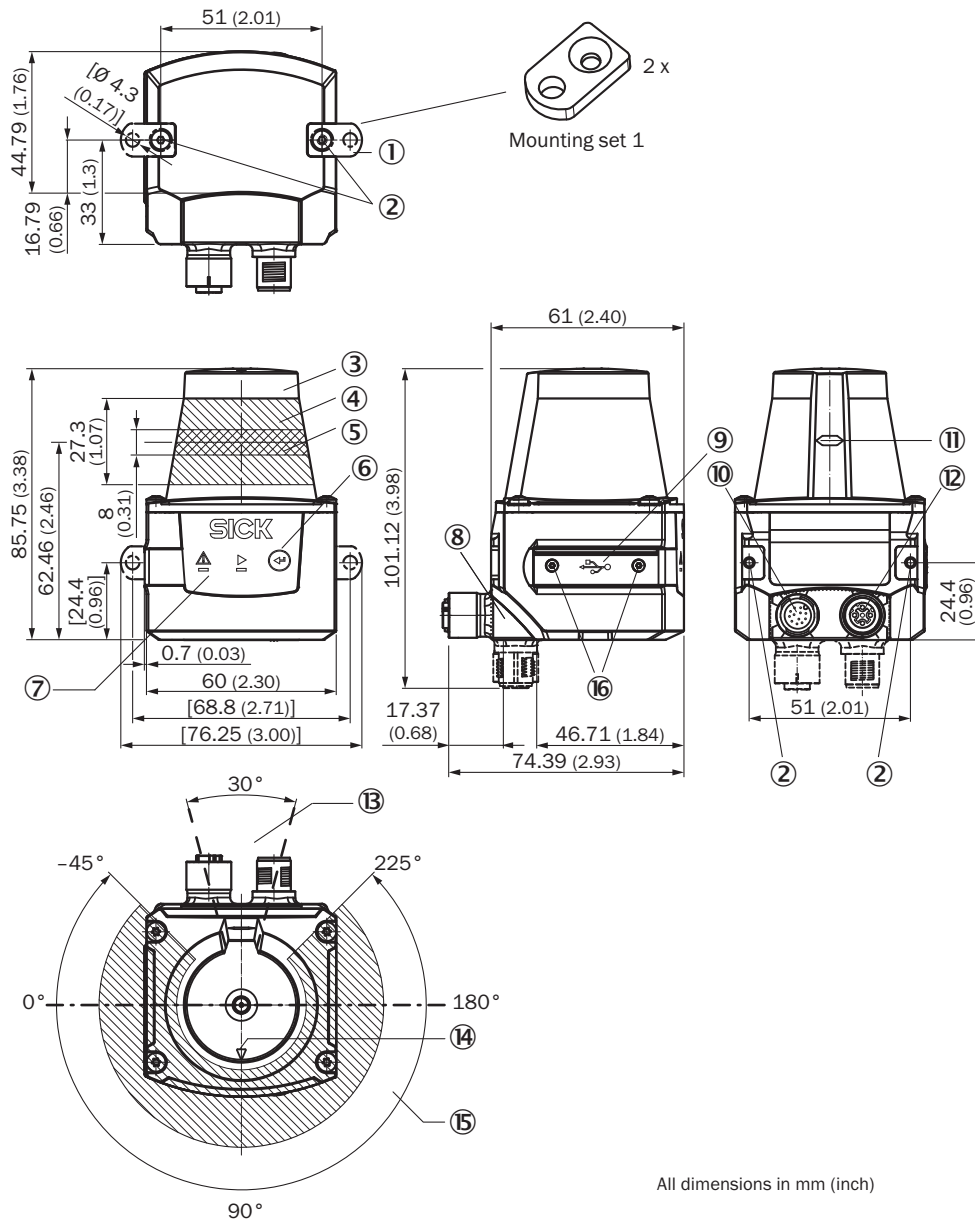

All dimensions in mm (inch)

- ① 2 x straight plates with M3 x 4 mm screw (included in delivery)
- ② M3 threaded mounting hole, 2.8 mm deep (blind hole thread), max. tightening torque 0.8 Nm
- ③ Optical hood
- ④ Receiving range (light inlet)
- ⑤ Transmission range (light emission)
- ⑥ Function button for teach-in
- ⑦ Red and green LED (status displays)
- ⑧ Swivel connector unit
- ⑨ Micro USB female connector, type B
- ⑩ Connection "Power", 12-pin, M12 male connector
- ⑪ Marking for the position of the light emission level
- ⑫ "Ethernet" connection, 4-pin M12 female connector
- ⑬ Area in which no reflective surfaces are allowed for mounted devices
- ⑭ Bearing marking to support alignment (90° axis)
- ⑮ Aperture angle 270° (scanning angle)
- ⑯ 2 x countersunk screw (Torx TX 6) M2 x 4 mm

### Working range diagram

Scanning range in m (feet)

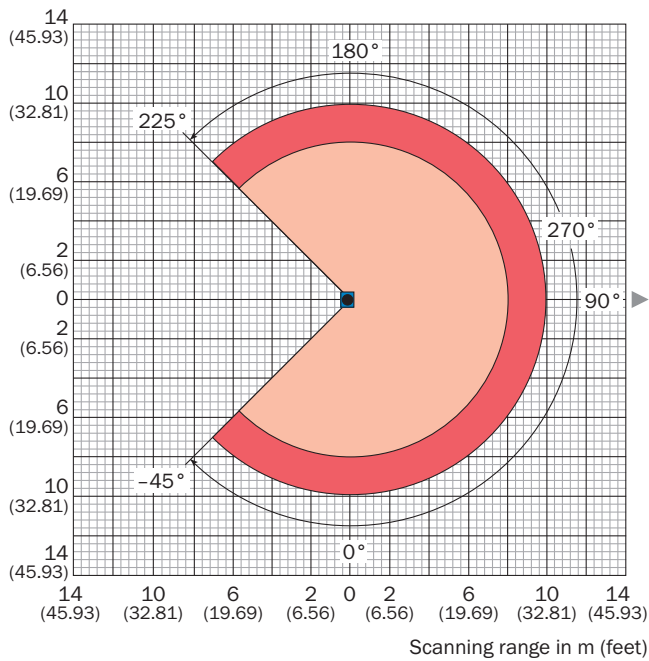

- Scanning range max. 10 m (32.81 feet)
- Scanning range typical 8 m (26.25 feet) for objects up to 10 % remission

### Connection type

Ethernet

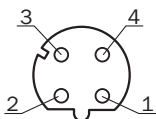

M12 female connector, 4-pin, D-coded

- ① TX+
- ② RX+
- ③ TX-
- ④ RX-

### PIN assignment

Power I/O connection

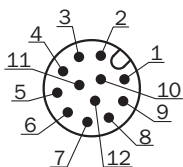





Connecting cable with male connector or M12 male connector, 12-pin, A-coded

- ① GND
- ② DC 9 V ... 28 V
- ③ In<sub>1</sub>
- ④ In<sub>2</sub>
- ⑤ OUT1
- ⑥ OUT2
- ⑦ OUT3
- ⑧ OUT4
- ⑨ PNP: INGND, NPN: IN 9 V ... 28 V
- ⑩ In<sub>3</sub>
- ⑪ In<sub>4</sub>
- ⑫ nc

## Recommended accessories

Other models and accessories → [www.sick.com/TiM](http://www.sick.com/TiM)

	Brief description	Type	Part no.
Mounting brackets and plates			
	Mounting kit with shock absorber, Anodized aluminum, mounting hardware included	Mounting kit	2086074
Others			
	<ul style="list-style-type: none"> <li>• <b>Connection type head A:</b> Male connector, M12, 4-pin, straight, D-coded</li> <li>• <b>Connection type head B:</b> Male connector, RJ45, 8-pin, straight</li> <li>• <b>Signal type:</b> PROFINET</li> <li>• <b>Cable:</b> 5 m, 4-wire, AWG26, PVC</li> <li>• <b>Description:</b> PROFINET, shielded</li> </ul>	YM2D24-050EB2MRJA4	6050200
	<ul style="list-style-type: none"> <li>• <b>Connection type head A:</b> Male connector, M12, 4-pin, straight, D-coded</li> <li>• <b>Connection type head B:</b> Male connector, RJ45, 4-pin, straight</li> <li>• <b>Signal type:</b> Ethernet, PROFINET</li> <li>• <b>Cable:</b> 5 m, 4-wire, PUR, halogen-free</li> <li>• <b>Description:</b> Ethernet, PROFINET, shielded</li> <li>• <b>Application:</b> Drag chain operation, Zones with oils and lubricants</li> </ul>	YM2D24-050PN1MRJA4	2106184
	<ul style="list-style-type: none"> <li>• <b>Connection type head A:</b> Male connector, Micro-B, 4-pin, straight</li> <li>• <b>Connection type head B:</b> Male connector, USB-A, 4-pin, straight</li> <li>• <b>Signal type:</b> USB 2.0</li> <li>• <b>Cable:</b> 2 m, 4-wire</li> <li>• <b>Description:</b> USB 2.0, unshielded</li> </ul>	USB cable	6036106
	<ul style="list-style-type: none"> <li>• <b>Connection type head A:</b> Female connector, M12, 12-pin, straight, A-coded</li> <li>• <b>Connection type head B:</b> Flying leads</li> <li>• <b>Signal type:</b> Sensor/actuator cable</li> <li>• <b>Cable:</b> 5 m, 12-wire, PUR</li> <li>• <b>Description:</b> Sensor/actuator cable, shielded</li> <li>• <b>Connection systems:</b> Flying leads</li> </ul>	YF2A6B-050UD3XLEAX	6054974

Recommended services

Additional services → [www.sick.com/TiM](http://www.sick.com/TiM)

	Type	Part no.
<b>Maintenance</b>		
<ul style="list-style-type: none"> <li>• <b>Product area:</b> 2D LiDAR sensors, 3D LiDAR sensors</li> <li>• <b>Range of services:</b> Inspection, analysis and restoring of defined functions, Inspection and adaptation of basic settings, parameters of field application, filters for raw data output, and product-specific configuration</li> <li>• <b>Duration:</b> Additional work will be invoiced separately</li> </ul>	Maintenance of LiDAR sensors	1682593
<b>Commissioning</b>		
<ul style="list-style-type: none"> <li>• <b>Product area:</b> 2D LiDAR sensors, 3D LiDAR sensors</li> <li>• <b>Range of services:</b> Inspection of connection, fine adjustment, configuration of monitored areas, configuration and optimization of parameters as well as tests, Setup of previously defined functions of basic settings, parameters of field application, filters for raw data output and product-specific configuration</li> <li>• <b>Duration:</b> Additional work will be invoiced separately</li> </ul>	Commissioning LiDAR sensors	1680672
<b>Extended warranty</b>		
<ul style="list-style-type: none"> <li>• <b>Product area:</b> Machine vision, LiDAR sensors, safety camera sensors, Safety laser scanners, Safety radar sensors, Radar sensors, Fixed mount barcode scanners, Image-based code readers, RFID, Mobile handheld scanners</li> <li>• <b>Range of services:</b> The services correspond to the scope of the statutory manufacturer warranty (SICK general terms of delivery).</li> <li>• <b>Duration:</b> Five-year warranty from delivery date.</li> </ul>	Extended warranty for a total of five years from delivery date	1680671



## SICK AT A GLANCE

SICK is one of the leading manufacturers of intelligent sensors and sensor solutions for industrial applications. A unique range of products and services creates the perfect basis for controlling processes securely and efficiently, protecting individuals from accidents and preventing damage to the environment.

We have extensive experience in a wide range of industries and understand their processes and requirements. With intelligent sensors, we can deliver exactly what our customers need. In application centers in Europe, Asia and North America, system solutions are tested and optimized in accordance with customer specifications. All this makes us a reliable supplier and development partner.

Comprehensive services complete our offering: SICK LifeTime Services provide support throughout the machine life cycle and ensure safety and productivity.

For us, that is “Sensor Intelligence.”

## WORLDWIDE PRESENCE:

Contacts and other locations –[www.sick.com](http://www.sick.com)