



TMM22E-PKK090

TMS/TMM22

INCLINATION SENSORS

SICK
Sensor Intelligence.



Illustration may differ

Ordering information

Type	Part no.
TMM22E-PKK090	1126910

Other models and accessories → www.sick.com/TMS_TMM22



Detailed technical data

Performance

Number of axis	2
Measuring range	± 90°
Resolution	≤ 0.015°
Static measurement accuracy	Typ. 0.25°, max. 0.6° ¹⁾
Repeatability	30 µA ²⁾
Compensated cross-sensitivity (2-dimensional)	Typ. ± 0.5°, max. ± 0.9°
Temperature coefficient (zero point)	±0.03°/K ³⁾
Limit frequency	2 Hz
Sampling rate	400 Hz

¹⁾ In accordance with DIN ISO 1319-1, position of the upper and lower error limit depends on the installation situation, specified value refers to a symmetrical position, i.e. deviation in upper and lower direction is the same.

²⁾ In accordance with DIN ISO 55350-13; 68.3% of the measured values are inside the specified area.

³⁾ 68.3% of the measured values are inside the specified area.

Interfaces

Communication interface	Analog / Current
Current output	4 mA ... 20 mA
0-set function via hardware pin	✓
Load resistance	200 Ω ... 900 Ω ¹⁾
Status information	
	LED 2x (green/red)
Output signal (error state)	2...3 mA
Initialization time	250 ms

¹⁾ At 24 V DC. Value depends on supply voltage and can be found in the operating instructions.

Electrical data

Connection type	Cable, 5-wire, 1.5 m
Supply voltage	12 V DC ... 30 V DC
Current consumption	< 30 mA (+ I _{loop}) @ 24 V

¹⁾ This product is a standard product and does not constitute a safety component as defined in the Machinery Directive. Calculation based on nominal load of components, average ambient temperature 40°C, frequency of use 8760 h/a. All electronic failures are considered hazardous. For more information, see document no. 8015532.

Reverse polarity protection	✓
Short-circuit protection of the outputs	✓
MTTFd: mean time to dangerous failure	961 years (EN ISO 13849-1) ¹⁾

¹⁾ This product is a standard product and does not constitute a safety component as defined in the Machinery Directive. Calculation based on nominal load of components, average ambient temperature 40 °C, frequency of use 8760 h/a. All electronic failures are considered hazardous. For more information, see document no. 8015532.

Mechanical data

Dimensions	38.8 mm x 30 mm x 10.4 mm
Weight	Approx. 60 g
Housing material	Plastic (PA12), glass-fiber reinforced
Material, cable	PUR

Ambient data

EMC	EN 61326-1
Enclosure rating	IP66, IP67, IP68, IP69K
Operating temperature range	-40 °C ... +80 °C
Storage temperature range	-40 °C ... +85 °C
Resistance to shocks	100 g, 6 ms (EN 60068-2-27)
Resistance to vibration	10 g, 10 Hz ... 2,000 Hz (EN 60068-2-6)

Classifications

ECLASS 5.0	27270790
ECLASS 5.1.4	27270790
ECLASS 6.0	27270790
ECLASS 6.2	27270790
ECLASS 7.0	27270790
ECLASS 8.0	27270790
ECLASS 8.1	27270790
ECLASS 9.0	27270790
ECLASS 10.0	27271101
ECLASS 11.0	27271101
ECLASS 12.0	27271101
ETIM 5.0	EC001852
ETIM 6.0	EC001852
ETIM 7.0	EC001852
ETIM 8.0	EC001852
UNSPSC 16.0901	41111613

Dimensional drawing (Dimensions in mm (inch))

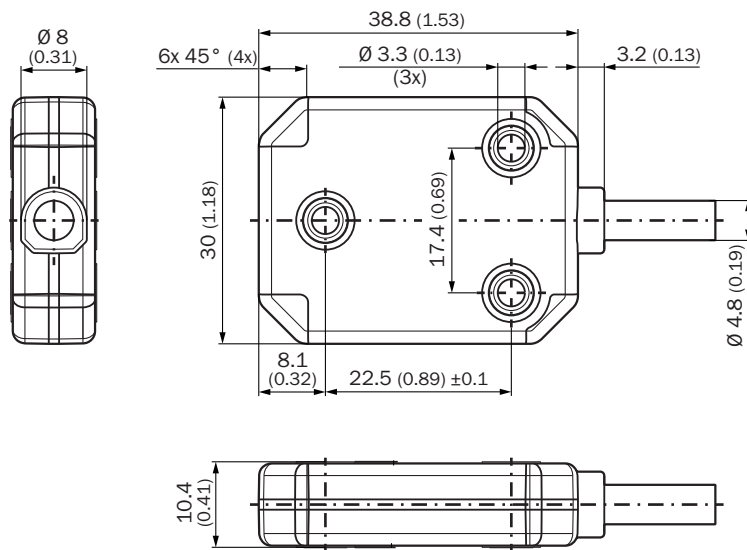

PIN assignment

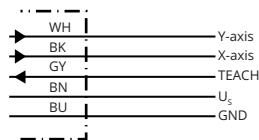

PIN	Wire colors (cable connection)	Signal TMS22E	Signal TMM22E
1	Brown	U _s	U _s
2	White	Z-axis	Y-axis
3	Blue	GND	GND
4	Black	n.c.	X-axis
5	Gray	TEACH ¹⁾	TEACH ¹⁾





¹⁾

To activate the zero point setting, connect TEACH (pin 5) to GND (pin 3) for at least 1 second.

Recommended accessories

Other models and accessories → www.sick.com/TMS_TMM22

Brief description	Type	Part no.
 <ul style="list-style-type: none"> Connection type head A: Female connector, M12, 5-pin, straight, A-coded Connection type head B: Flying leads Signal type: Sensor/actuator cable Cable: 1.5 m, 5-wire, PUR, halogen-free Description: Sensor/actuator cable, shielded Application: Zones with oils and lubricants, Drag chain operation, Robot 	YF2A25-015UB6XLEAX	2095833

	Brief description	Type	Part no.
	<ul style="list-style-type: none"> • Connection type head A: Female connector, M12, 5-pin, straight, A-coded • Connection type head B: Flying leads • Signal type: Sensor/actuator cable • Cable: 3 m, 5-wire, PUR, halogen-free • Description: Sensor/actuator cable, shielded • Application: Zones with oils and lubricants, Drag chain operation, Robot 	YF2A25-030UB6XLEAX	2095834
	<ul style="list-style-type: none"> • Connection type head A: Female connector, M12, 5-pin, straight, A-coded • Connection type head B: Flying leads • Signal type: Sensor/actuator cable • Cable: 5 m, 5-wire, PUR, halogen-free • Description: Sensor/actuator cable, shielded • Application: Zones with oils and lubricants, Drag chain operation, Robot 	YF2A25-050UB6XLEAX	2095733
	<ul style="list-style-type: none"> • Connection type head A: Female connector, M12, 5-pin, angled, A-coded • Connection type head B: Flying leads • Signal type: Sensor/actuator cable • Cable: 3 m, 5-wire, PUR, halogen-free • Description: Sensor/actuator cable, shielded • Application: Zones with oils and lubricants, Drag chain operation, Robot 	YG2A25-030UB6XLEAX	2095791
	<ul style="list-style-type: none"> • Connection type head A: Male connector, M12, 5-pin, straight, A-coded • Description: Unshielded, Head A: male connector, M12, 5-pin, straight, unshielded, for cable diameter 4 mm ... 6 mm Head B: - • Connection systems: Screw-type terminals • Permitted cross-section: ≤ 0.75 mm² • Note: For field bus technology 	STE-1205-G	6022083
	<ul style="list-style-type: none"> • Connection type head A: Female connector, M12, 5-pin, straight, A-coded • Description: Unshielded, Head A: female connector, M12, 5-pin, straight, unshielded, for cable diameter 4 mm ... 6 mm Head B: - • Connection systems: Screw-type terminals • Permitted cross-section: ≤ 0.75 mm² 	DOS-1205-G	6009719

SICK AT A GLANCE

SICK is one of the leading manufacturers of intelligent sensors and sensor solutions for industrial applications. A unique range of products and services creates the perfect basis for controlling processes securely and efficiently, protecting individuals from accidents and preventing damage to the environment.

We have extensive experience in a wide range of industries and understand their processes and requirements. With intelligent sensors, we can deliver exactly what our customers need. In application centers in Europe, Asia and North America, system solutions are tested and optimized in accordance with customer specifications. All this makes us a reliable supplier and development partner.

Comprehensive services complete our offering: SICK LifeTime Services provide support throughout the machine life cycle and ensure safety and productivity.

For us, that is “Sensor Intelligence.”

WORLDWIDE PRESENCE:

Contacts and other locations –www.sick.com