



# TMS22E-PKK120

TMS/TMM22

INCLINATION SENSORS

**SICK**  
Sensor Intelligence.



Illustration may differ

### Ordering information

| Type          | Part no. |
|---------------|----------|
| TMS22E-PKK120 | 1121983  |

Other models and accessories → [www.sick.com/TMS\\_TMM22](http://www.sick.com/TMS_TMM22)



### Detailed technical data

#### Performance

|   |                                     |
|---|-------------------------------------|
| <b>Number of axis</b>                       | 1                                   |
| <b>Measuring range</b>                      | 120°                                |
| <b>Resolution</b>                           | ≤ 0.03°                             |
| <b>Static measurement accuracy</b>          | Typ. 0.25°, max. 0.4° <sup>1)</sup> |
| <b>Repeatability</b>                        | 30 µA <sup>2)</sup>                 |
| <b>Temperature coefficient (zero point)</b> | ±0.03°/K <sup>3)</sup>              |
| <b>Limit frequency</b>                      | 2 Hz                                |
| <b>Sampling rate</b>                        | 400 Hz                              |

<sup>1)</sup> In accordance with DIN ISO 1319-1, position of the upper and lower error limit depends on the installation situation, specified value refers to a symmetrical position, i.e. deviation in upper and lower direction is the same.

<sup>2)</sup> In accordance with DIN ISO 55350-13; 68.3% of the measured values are inside the specified area.

<sup>3)</sup> 68.3% of the measured values are inside the specified area.

#### Interfaces

|  |                               |
|--|-------------------------------|
| <b>Communication interface</b>         | Analog / Current              |
| <b>Current output</b>                  | 4 mA ... 20 mA                |
| <b>0-set function via hardware pin</b> | ✓                             |
| <b>Load resistance</b>                 | 200 Ω ... 900 Ω <sup>1)</sup> |
| <b>Status information</b>              |                               |
| LED                                    | 2x (green/red)                |
| Output signal (error state)            | 2...3 mA                      |
| <b>Initialization time</b>             | 250 ms                        |

<sup>1)</sup> At 24 V DC. Value depends on supply voltage and can be found in the operating instructions.

#### Electrical data

|                                    |                                       |
|------------------------------------|---------------------------------------|
| <b>Connection type</b>             | Cable, 5-wire, 1.5 m                  |
| <b>Supply voltage</b>              | 12 V DC ... 30 V DC                   |
| <b>Current consumption</b>         | < 30 mA (+ I <sub>loop</sub> ) @ 24 V |
| <b>Reverse polarity protection</b> | ✓                                     |

<sup>1)</sup> This product is a standard product and does not constitute a safety component as defined in the Machinery Directive. Calculation based on nominal load of components, average ambient temperature 40°C, frequency of use 8760 h/a. All electronic failures are considered hazardous. For more information, see document no. 8015532.

|  |  |
|--|--|
| <b>Short-circuit protection of the outputs</b> | ✓  |
| <b>MTTFd: mean time to dangerous failure</b>   | 961 years (EN ISO 13849-1) <sup>1)</sup> |

<sup>1)</sup> This product is a standard product and does not constitute a safety component as defined in the Machinery Directive. Calculation based on nominal load of components, average ambient temperature 40 °C, frequency of use 8760 h/a. All electronic failures are considered hazardous. For more information, see document no. 8015532.

### Mechanical data

|                         |  |
|-------------------------|--|
| <b>Dimensions</b>       | 38.8 mm x 30 mm x 10.4 mm              |
| <b>Weight</b>           | Approx. 60 g                           |
| <b>Housing material</b> | Plastic (PA12), glass-fiber reinforced |
| <b>Material, cable</b>  | PUR                                    |

### Ambient data

|                                    |   |
|------------------------------------|---|
| <b>EMC</b>                         | EN 61326-1                              |
| <b>Enclosure rating</b>            | IP66, IP67, IP68, IP69K                 |
| <b>Operating temperature range</b> | -40 °C ... +80 °C                       |
| <b>Storage temperature range</b>   | -40 °C ... +85 °C                       |
| <b>Resistance to shocks</b>        | 100 g, 6 ms (EN 60068-2-27)             |
| <b>Resistance to vibration</b>     | 10 g, 10 Hz ... 2,000 Hz (EN 60068-2-6) |

### Classifications

|                       |          |
|-----------------------|----------|
| <b>ECLASS 5.0</b>     | 27270790 |
| <b>ECLASS 5.1.4</b>   | 27270790 |
| <b>ECLASS 6.0</b>     | 27270790 |
| <b>ECLASS 6.2</b>     | 27270790 |
| <b>ECLASS 7.0</b>     | 27270790 |
| <b>ECLASS 8.0</b>     | 27270790 |
| <b>ECLASS 8.1</b>     | 27270790 |
| <b>ECLASS 9.0</b>     | 27270790 |
| <b>ECLASS 10.0</b>    | 27271101 |
| <b>ECLASS 11.0</b>    | 27271101 |
| <b>ECLASS 12.0</b>    | 27271101 |
| <b>ETIM 5.0</b>       | EC001852 |
| <b>ETIM 6.0</b>       | EC001852 |
| <b>ETIM 7.0</b>       | EC001852 |
| <b>ETIM 8.0</b>       | EC001852 |
| <b>UNSPSC 16.0901</b> | 41111613 |

### Dimensional drawing (Dimensions in mm (inch))

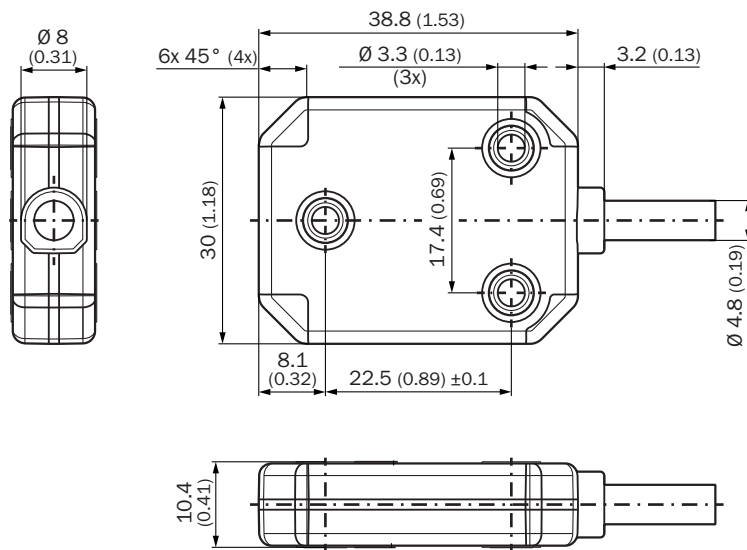

### PIN assignment

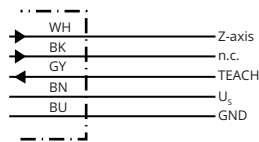

| PIN | Wire colors (cable connection) | Signal TMS22E       | Signal TMM22E       |
|-----|--------------------------------|---------------------|---------------------|
| 1   | Brown                          | U <sub>s</sub>      | U <sub>s</sub>      |
| 2   | White                          | Z-axis              | Y-axis              |
| 3   | Blue                           | GND                 | GND                 |
| 4   | Black                          | n.c.                | X-axis              |
| 5   | Gray                           | TEACH <sup>1)</sup> | TEACH <sup>1)</sup> |





<sup>1)</sup>

To activate the zero point setting, connect TEACH (pin 5) to GND (pin 3) for at least 1 second.

### Recommended accessories

Other models and accessories → [www.sick.com/TMS\\_TMM22](http://www.sick.com/TMS_TMM22)

| Brief description  | Type               | Part no. |
|--|--------------------|----------|
|  <ul style="list-style-type: none"> <li><b>Connection type head A:</b> Female connector, M12, 5-pin, straight, A-coded</li> <li><b>Connection type head B:</b> Flying leads</li> <li><b>Signal type:</b> Sensor/actuator cable</li> <li><b>Cable:</b> 1.5 m, 5-wire, PUR, halogen-free</li> <li><b>Description:</b> Sensor/actuator cable, shielded</li> <li><b>Application:</b> Zones with oils and lubricants, Drag chain operation, Robot</li> </ul> | YF2A25-015UB6XLEAX | 2095833  |

|   | Brief description  | Type               | Part no. |
|---|--|--------------------|----------|
|  | <ul style="list-style-type: none"> <li>• <b>Connection type head A:</b> Female connector, M12, 5-pin, straight, A-coded</li> <li>• <b>Connection type head B:</b> Flying leads</li> <li>• <b>Signal type:</b> Sensor/actuator cable</li> <li>• <b>Cable:</b> 3 m, 5-wire, PUR, halogen-free</li> <li>• <b>Description:</b> Sensor/actuator cable, shielded</li> <li>• <b>Application:</b> Zones with oils and lubricants, Drag chain operation, Robot</li> </ul> | YF2A25-030UB6XLEAX | 2095834  |
|  | <ul style="list-style-type: none"> <li>• <b>Connection type head A:</b> Female connector, M12, 5-pin, straight, A-coded</li> <li>• <b>Connection type head B:</b> Flying leads</li> <li>• <b>Signal type:</b> Sensor/actuator cable</li> <li>• <b>Cable:</b> 5 m, 5-wire, PUR, halogen-free</li> <li>• <b>Description:</b> Sensor/actuator cable, shielded</li> <li>• <b>Application:</b> Zones with oils and lubricants, Drag chain operation, Robot</li> </ul> | YF2A25-050UB6XLEAX | 2095733  |
|  | <ul style="list-style-type: none"> <li>• <b>Connection type head A:</b> Female connector, M12, 5-pin, angled, A-coded</li> <li>• <b>Connection type head B:</b> Flying leads</li> <li>• <b>Signal type:</b> Sensor/actuator cable</li> <li>• <b>Cable:</b> 3 m, 5-wire, PUR, halogen-free</li> <li>• <b>Description:</b> Sensor/actuator cable, shielded</li> <li>• <b>Application:</b> Zones with oils and lubricants, Drag chain operation, Robot</li> </ul>   | YG2A25-030UB6XLEAX | 2095791  |
|  | <ul style="list-style-type: none"> <li>• <b>Connection type head A:</b> Male connector, M12, 5-pin, straight, A-coded</li> <li>• <b>Description:</b> Unshielded, Head A: male connector, M12, 5-pin, straight, unshielded, for cable diameter 4 mm ... 6 mm Head B: -</li> <li>• <b>Connection systems:</b> Screw-type terminals</li> <li>• <b>Permitted cross-section:</b> ≤ 0.75 mm<sup>2</sup></li> <li>• <b>Note:</b> For field bus technology</li> </ul>    | STE-1205-G         | 6022083  |
|  | <ul style="list-style-type: none"> <li>• <b>Connection type head A:</b> Female connector, M12, 5-pin, straight, A-coded</li> <li>• <b>Description:</b> Unshielded, Head A: female connector, M12, 5-pin, straight, unshielded, for cable diameter 4 mm ... 6 mm Head B: -</li> <li>• <b>Connection systems:</b> Screw-type terminals</li> <li>• <b>Permitted cross-section:</b> ≤ 0.75 mm<sup>2</sup></li> </ul>   | DOS-1205-G         | 6009719  |

## SICK AT A GLANCE

SICK is one of the leading manufacturers of intelligent sensors and sensor solutions for industrial applications. A unique range of products and services creates the perfect basis for controlling processes securely and efficiently, protecting individuals from accidents and preventing damage to the environment.

We have extensive experience in a wide range of industries and understand their processes and requirements. With intelligent sensors, we can deliver exactly what our customers need. In application centers in Europe, Asia and North America, system solutions are tested and optimized in accordance with customer specifications. All this makes us a reliable supplier and development partner.

Comprehensive services complete our offering: SICK LifeTime Services provide support throughout the machine life cycle and ensure safety and productivity.

For us, that is “Sensor Intelligence.”

## WORLDWIDE PRESENCE:

Contacts and other locations –[www.sick.com](http://www.sick.com)