



UC12-1223E

UC12

ULTRASONIC DISTANCE SENSORS

SICK
Sensor Intelligence.



Ordering information

Type	Part no.
UC12-1223E	6077703

Other models and accessories → www.sick.com/UC12



Detailed technical data

Features

Operating range, limiting range	55 mm ... 250 mm, 350 mm
Target	Natural objects
Resolution	≥ 0.1 mm
Repeatability	± 0.15 % ¹⁾
Measurement accuracy	± 1 % ²⁾
Temperature compensation	✓
Response time	30 ms
Switching frequency	25 Hz
Output time	8 ms
Ultrasonic frequency (typical)	500 kHz
Detection area (typical)	See diagrams
Additional function	Set switching mode: Distance to object (DtO) / Window (Wnd) / Object between sensor and background (ObSB), teach-in of digital output, teach-in button(s) (can be deactivated), reset to factory default

¹⁾ In relation to the current measured value, minimum value ≥ resolution.

²⁾ Referring to current measurement value.

Interfaces

IO-Link	✓, IO-Link V1.1
Function	Process data, parameterization, diagnosis, data storage
Digital output	
Number	2 ¹⁾
Type	Push-pull: PNP/NPN

¹⁾ Push-pull: PNP/NPN HIGH = $U_V - (< 0.6 V)$ / LOW < 0.6 V.

	Function	Complementary digital outputs (Q, \bar{Q})
	Maximum output current I_A	≤ 100 mA
Hysteresis		2 mm

¹⁾ Push-pull: PNP/NPN HIGH = $U_V - (< 0.6$ V) / LOW < 0.6 V.

Electronics

Supply voltage U_B	DC 10 V ... 30 V ¹⁾
Power consumption	≤ 1.2 W ²⁾
Initialization time	< 300 ms
Indication	1 x LED
Enclosure rating	IP65 / IP67
Protection class	III

¹⁾ Limit values, reverse-polarity protected, operation in short-circuit protected network: max. 8 A.

²⁾ Without load.

Mechanics

Dimensions (W x H x D)	15 mm x 48.8 mm x 43.5 mm
Design	Rectangular
Sending axis	Straight
Housing material	Metal (zinc diecast, ultrasonic transducer: polyurethane foam, glass epoxy resin)
Weight	75 g
Connection type	Male connector, M12, 4-pin

Ambient data

Ambient temperature, operation	-25 °C ... +70 °C
Ambient temperature, storage	-40 °C ... +85 °C

Classifications

ECLASS 5.0	27270804
ECLASS 5.1.4	27270804
ECLASS 6.0	27270804
ECLASS 6.2	27270804
ECLASS 7.0	27270804
ECLASS 8.0	27270804
ECLASS 8.1	27270804
ECLASS 9.0	27270804
ECLASS 10.0	27270804
ECLASS 11.0	27270804
ECLASS 12.0	27272806
ETIM 5.0	EC001846
ETIM 6.0	EC001846
ETIM 7.0	EC001846
ETIM 8.0	EC001846
UNSPSC 16.0901	41111960

Dimensional drawing (Dimensions in mm (inch))

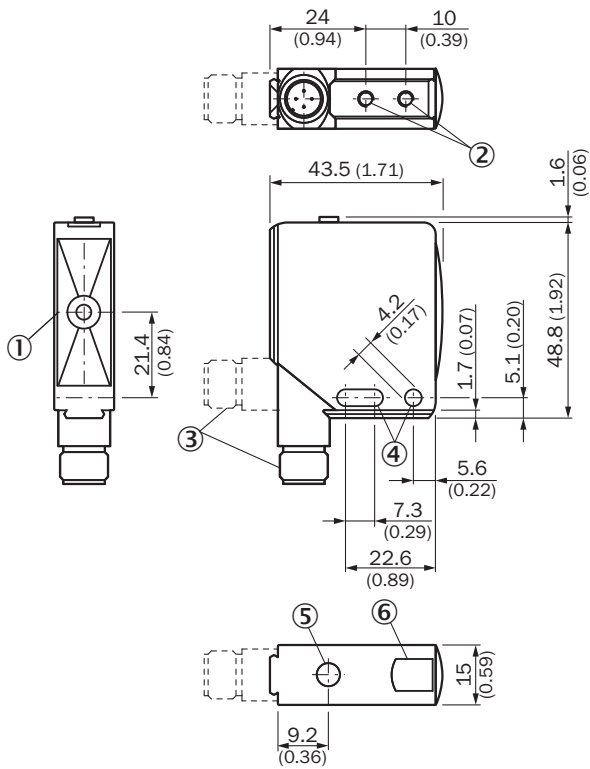

- ① Sender and receiver axis
- ② M4 threaded mounting hole, 4 mm deep
- ③ Connection
- ④ Fixing hole
- ⑤ Control elements
- ⑥ Status indicator digital output (orange) and power on (green)

Connection diagram

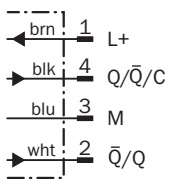

Detection area

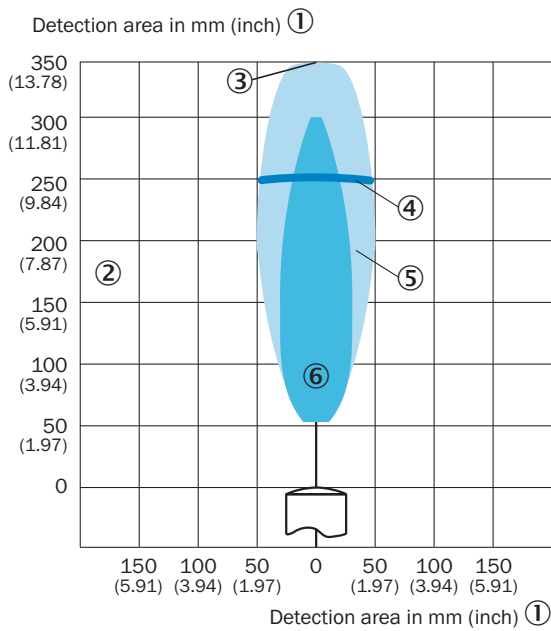

UC12-12



- ① Detection area in mm (inch)
- ② Detection range dependent on reflection properties, size, and alignment of the object
- ③ Limiting range
- ④ Operating range
- ⑤ Example object: aligned plate 10 mm x 10 mm
- ⑥ Example object: cylindrical bar with a diameter of 10 mm

Recommended accessories

Other models and accessories → www.sick.com/UC12

	Brief description	Type	Part no.
Mounting brackets and plates			
	Mounting bracket, small, stainless steel, mounting hardware included	BEF-WK-W12	2012938
Others			
	<ul style="list-style-type: none"> • Connection type head A: Female connector, M12, 4-pin, straight, A-coded • Connection type head B: Flying leads • Signal type: Sensor/actuator cable • Cable: 2 m, 4-wire, PVC • Description: Sensor/actuator cable, unshielded • Application: Zones with chemicals 	YF2A14-020VB3XLEAX	2096234

SICK AT A GLANCE

SICK is one of the leading manufacturers of intelligent sensors and sensor solutions for industrial applications. A unique range of products and services creates the perfect basis for controlling processes securely and efficiently, protecting individuals from accidents and preventing damage to the environment.

We have extensive experience in a wide range of industries and understand their processes and requirements. With intelligent sensors, we can deliver exactly what our customers need. In application centers in Europe, Asia and North America, system solutions are tested and optimized in accordance with customer specifications. All this makes us a reliable supplier and development partner.

Comprehensive services complete our offering: SICK LifeTime Services provide support throughout the machine life cycle and ensure safety and productivity.

For us, that is “Sensor Intelligence.”

WORLDWIDE PRESENCE:

Contacts and other locations –www.sick.com