



UC4-11341

UC4

ULTRASONIC DISTANCE SENSORS

**SICK**  
Sensor Intelligence.



### Ordering information

Type	Part no.
UC4-11341	6034667

Other models and accessories → [www.sick.com/UC4](http://www.sick.com/UC4)



### Detailed technical data

#### Features

<b>Operating range, limiting range</b>	13 mm ... 100 mm, 150 mm <sup>1)</sup>
<b>Target</b>	Natural objects
<b>Resolution</b>	≥ 0.1 mm
<b>Repeatability</b>	± 0.15 % <sup>2)</sup>
<b>Measurement accuracy</b>	± 1 % <sup>3)</sup>
<b>Response time</b>	24 ms
<b>Switching frequency</b>	30 Hz
<b>Output time</b>	8 ms
<b>Ultrasonic frequency (typical)</b>	380 kHz
<b>Detection area (typical)</b>	See diagrams
<b>Additional function</b>	Adjustable operating modes: Switching point (DtO) / Switching window/Background (ObSB), teach-in of digital output, invertable digital output, teach-in button(s) (can be deactivated), reset to factory default <sup>4)</sup>
<b>Safety-related parameters</b>	
	MTTF <sub>D</sub> 101 years
	DC <sub>avg</sub> 0%

<sup>1)</sup> Teach-in from 21 mm.

<sup>2)</sup> In relation to the current measured value, minimum value ≥ resolution.

<sup>3)</sup> Referring to current measurement value.

<sup>4)</sup> Functions may vary depending on sensor type.

#### Interfaces

<b>Digital output</b>		
	Number	1 <sup>1)</sup>
	Type	PNP
	Maximum output current I <sub>A</sub>	≤ 200 mA

<sup>1)</sup> PNP: HIGH = V<sub>S</sub> - (< 2 V) / LOW = 0 V.

<b>Hysteresis</b>	2 mm
-------------------	------

<sup>1)</sup> PNP: HIGH =  $V_S - (< 2 \text{ V})$  / LOW = 0 V.

## Electronics

<b>Supply voltage <math>U_B</math></b>	DC 15 V ... 30 V <sup>1)</sup>
<b>Power consumption</b>	$\leq 0.75 \text{ W}^2)$
<b>Initialization time</b>	< 300 ms
<b>Indication</b>	2 x LED
<b>Enclosure rating</b>	IP65 / IP67
<b>Protection class</b>	III

<sup>1)</sup> Limit values, reverse-polarity protected, operation in short-circuit protected network: max. 8 A.

<sup>2)</sup> Without load.

## Mechanics

<b>Dimensions (W x H x D)</b>	16 mm x 40.1 mm x 16.7 mm
<b>Design</b>	Rectangular
<b>Sending axis</b>	Straight
<b>Housing material</b>	Plastic (ABS, ultrasonic transducer: polyurethane foam, glass epoxy resin)
<b>Weight</b>	10 g
<b>Connection type</b>	Male connector, M8, 3-pin

## Ambient data

<b>Ambient temperature, operation</b>	-25 °C ... +70 °C <sup>1)</sup>
<b>Ambient temperature, storage</b>	-40 °C ... +85 °C
<b>Temperature drift</b>	0.17 % / K <sup>2)</sup>

<sup>1)</sup> At operating temperatures of > 50 °C, the rear side of the UC4 must be installed with its surface flat against a bracket.

<sup>2)</sup> Referring to current measurement value.

## Classifications

<b>ECLASS 5.0</b>	27270804
<b>ECLASS 5.1.4</b>	27270804
<b>ECLASS 6.0</b>	27270804
<b>ECLASS 6.2</b>	27270804
<b>ECLASS 7.0</b>	27270804
<b>ECLASS 8.0</b>	27270804
<b>ECLASS 8.1</b>	27270804
<b>ECLASS 9.0</b>	27270804
<b>ECLASS 10.0</b>	27270804
<b>ECLASS 11.0</b>	27270804
<b>ECLASS 12.0</b>	27272806
<b>ETIM 5.0</b>	EC001846
<b>ETIM 6.0</b>	EC001846
<b>ETIM 7.0</b>	EC001846
<b>ETIM 8.0</b>	EC001846

Dimensional drawing (Dimensions in mm (inch))

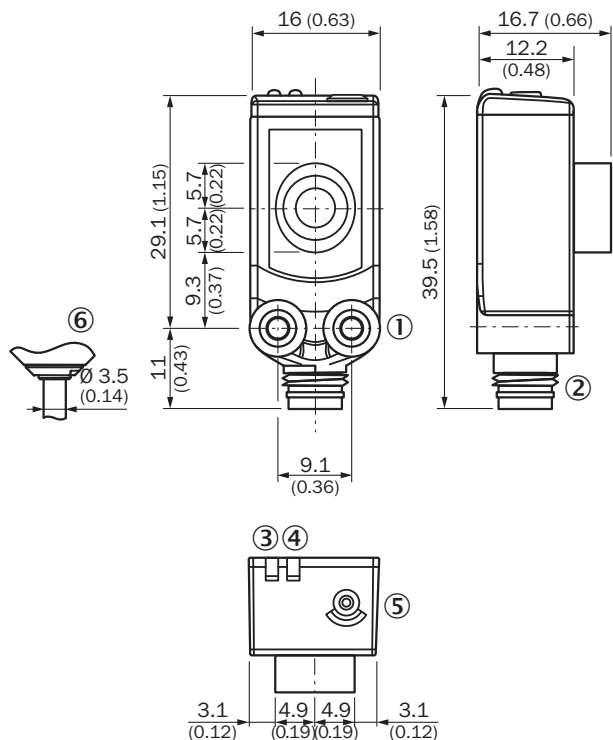

- ① Threaded mounting hole M3
- ② Connection
- ③ Status indicator digital output (orange)
- ④ Status display for supply voltage active (green)
- ⑤ Control elements

Connection type

Connector M8, 3-pin

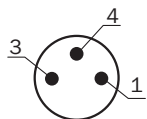

Connection diagram

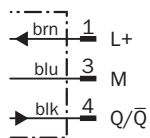

### Adjustment possible

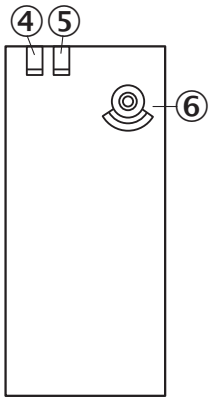

- ④ Status indicator digital output (orange)
- ⑤ Status display for supply voltage active (green)
- ⑥ Control elements

### Detection area

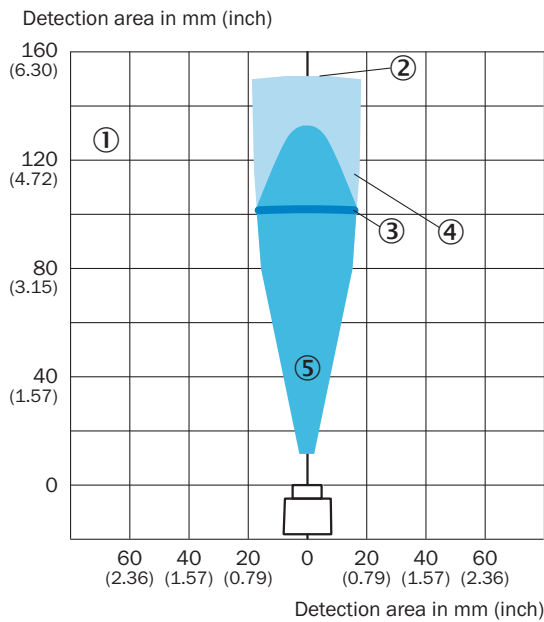

UC4-11



- ① Detection range dependent on reflection properties, size, and alignment of the object
- ② Limiting range
- ③ Operating range
- ④ Example object: aligned plate 100 mm x 100 mm
- ⑤ Example object: cylindrical bar with a diameter of 10 mm

### Recommended accessories

Other models and accessories → [www.sick.com/UC4](http://www.sick.com/UC4)

	Brief description	Type	Part no.
Hardware			
	Accessory for ultrasonic channeling for the product family UC4	SonicTube UC4	5329249
Mounting brackets and plates			
	Mounting bracket for wall mounting, Stainless steel 1.4571, mounting hardware included	BEF-W4-A	2051628
Others			
	<ul style="list-style-type: none"> <li>• <b>Connection type head A:</b> Female connector, M8, 3-pin, straight, A-coded</li> <li>• <b>Connection type head B:</b> Flying leads</li> <li>• <b>Signal type:</b> Sensor/actuator cable</li> <li>• <b>Cable:</b> 2 m, 3-wire, PVC</li> <li>• <b>Description:</b> Sensor/actuator cable, unshielded</li> <li>• <b>Application:</b> Zones with chemicals</li> </ul>	YF8U13-020VA1XLEAX	2095860

## SICK AT A GLANCE

SICK is one of the leading manufacturers of intelligent sensors and sensor solutions for industrial applications. A unique range of products and services creates the perfect basis for controlling processes securely and efficiently, protecting individuals from accidents and preventing damage to the environment.

We have extensive experience in a wide range of industries and understand their processes and requirements. With intelligent sensors, we can deliver exactly what our customers need. In application centers in Europe, Asia and North America, system solutions are tested and optimized in accordance with customer specifications. All this makes us a reliable supplier and development partner.

Comprehensive services complete our offering: SICK LifeTime Services provide support throughout the machine life cycle and ensure safety and productivity.

For us, that is “Sensor Intelligence.”

## WORLDWIDE PRESENCE:

Contacts and other locations –[www.sick.com](http://www.sick.com)