

UFN3-70P415

UF

FORK SENSORS

SICK
Sensor Intelligence.

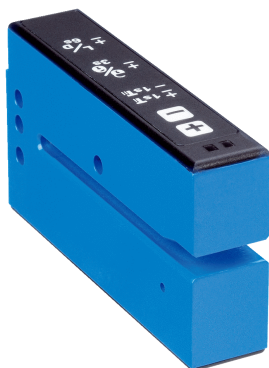

Illustration may differ



Ordering information

Type	Part no.
UFN3-70P415	6049679

Other models and accessories → www.sick.com/UF

Detailed technical data

Features

Functional principle detail	Ultrasonic detection principle
Dimensions (W x H x D)	18 mm x 47.5 mm x 92.5 mm
Housing design	Fork shaped
Fork width	3 mm
Fork depth	69 mm
Minimum detectable object (MDO)	Gap between Labels / Size of labels: 2 mm ¹⁾
Label detection	✓
Adjustment	Plus/minus button, cable (Teach-in, sensitivity, light/dark switching, Teach-in dynamic)
Teach-in mode	2-point teach-in Teach-in dynamic

¹⁾ Depends on the label thickness.

Mechanics/electronics

Supply voltage	10 V DC ... 30 V DC ¹⁾
Ripple	< 10 % ²⁾
Current consumption	40 mA ³⁾
Switching frequency	1.5 kHz ⁴⁾
Response time	250 μs ⁵⁾
Switching output	PNP
Switching output (voltage)	PNP: HIGH = $U_V \leq 2 \text{ V}$ / LOW approx. 0 V

¹⁾ Limit values, reverse-polarity protected, operation in short-circuit protected network: max. 8 A.

²⁾ May not exceed or fall below U_V tolerances.

³⁾ Without load.

⁴⁾ With light/dark ratio 1:1, typical, depending on material and speed.

⁵⁾ Signal transit time with resistive load.

⁶⁾ Output current minimal 0.03 mA.

⁷⁾ Reference voltage DC 50 V.

Switching mode	Light/dark switching
Output current I_{max}	100 mA ⁶⁾
Input, teach-in (ET)	Teach: U > 7 V ... < U _v Run: U < 2 V
Initialization time	100 ms
Connection type	Male connector M8, 4-pin
Protection class	III ⁷⁾
Circuit protection	Output Q short-circuit protected Interference pulse suppression
Enclosure rating	IP65
Weight	95 g
Housing material	Metal, Aluminum

¹⁾ Limit values, reverse-polarity protected, operation in short-circuit protected network: max. 8 A.

²⁾ May not exceed or fall below U_v tolerances.

³⁾ Without load.

⁴⁾ With light/dark ratio 1:1, typical, depending on material and speed.

⁵⁾ Signal transit time with resistive load.

⁶⁾ Output current minimal 0.03 mA.

⁷⁾ Reference voltage DC 50 V.

Safety-related parameters

MTTF_D	207 years
DC_{avg}	0 %

Ambient data

Ambient operating temperature	+5 °C ... +55 °C ¹⁾
Ambient temperature, storage	-20 °C ... +70 °C
Shock load	According to EN 60068-2-27
EMC	EN 60947-5-2 ²⁾
UL File No.	NRKH.E191603 & NRKH7.E191603

¹⁾ Do not bend below 0 °C.

²⁾ The UFN complies with the Radio Safety Requirements (EMC) for the industrial sector (Radio Safety Class A). It may cause radio interference if used in residential areas.

Classifications

ECLASS 5.0	27270909
ECLASS 5.1.4	27270909
ECLASS 6.0	27270909
ECLASS 6.2	27270909
ECLASS 7.0	27270909
ECLASS 8.0	27270909
ECLASS 8.1	27270909
ECLASS 9.0	27270909
ECLASS 10.0	27270909
ECLASS 11.0	27270909
ECLASS 12.0	27270909

ETIM 5.0	EC002720
ETIM 6.0	EC002720
ETIM 7.0	EC002720
ETIM 8.0	EC002720
UNSPSC 16.0901	39121528

Dimensional drawing (Dimensions in mm (inch))

UFnext - Plus/minus buttons

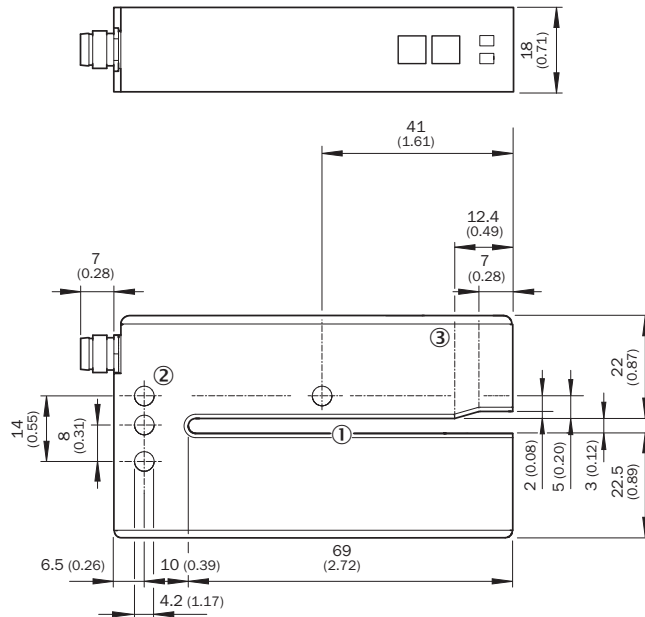

- ① Fork opening: fork width 3 mm, forks depth 69 mm
- ② Mounting hole, Ø 4.2 mm
- ③ Detection axis

Adjustments

Adjustment: teach-in via plus/minus buttons (WFxx-B416)

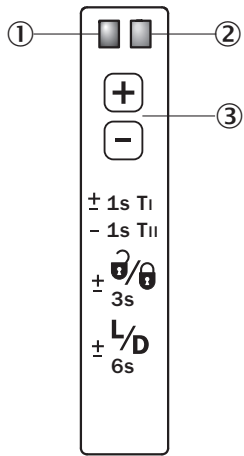

- ① Function signal indicator (yellow), switching output
- ② Function indicator (red)
- ③ “+”/“-” buttons and function button

Connection diagram

Cd-092

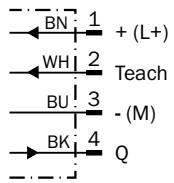

Concept of operation

Teach-in dynamic via plus/minus buttons

1. Position label or substrate in the active area of the fork sensor

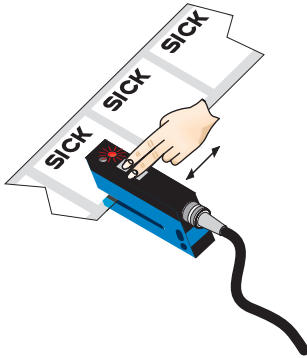

Press both the “+” and “-” buttons together, hold > 1 s and then release the teach-in buttons. The red LED flashes.

2. Move multiple labels through the fork sensor

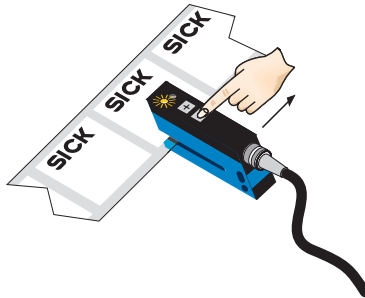

Press “-” button, teach-in process is finished.

Notes

Switching threshold adaptation:

Only, the first teach-in procedure after switching on is permanently stored. Teach-in can be repeated cyclically. Switching output also during teach-in active.

+ Once teach-in process is complete, the switching threshold can be adjusted at any time using the “+” or “-” button. To make minor adjustments, press the “+” or “-” button once. To configure settings quickly, keep the “+” or “-” button pressed for longer.

± 3s Press both the “+” and “-” buttons together (3 seconds) to lock the device and prevent unintentional actuation.

± L/D 6s Press both the “+” and “-” buttons together (6 seconds) to define the switching function (light/dark switching). Standard setting: Q = light switching.

Teach-in (static): Setting the switching threshold without movements of label, cf. operating instruction.

Recommended accessories

Other models and accessories → www.sick.com/UF

	Brief description	Type	Part no.
Plug connectors and cables			
	<ul style="list-style-type: none"> Connection type head A: Female connector, M8, 4-pin, straight, A-coded Connection type head B: Flying leads Signal type: Sensor/actuator cable Cable: 5 m, 4-wire, PVC Description: Sensor/actuator cable, unshielded Application: Zones with chemicals 	YF8U14-050VA3XLEAX	2095889

	Brief description	Type	Part no.
	<ul style="list-style-type: none"> • Connection type head A: Male connector, M8, 4-pin, straight • Description: Unshielded • Connection systems: Screw-type terminals • Permitted cross-section: 0.14 mm² ... 0.5 mm² 	STE-0804-G	6037323

SICK AT A GLANCE

SICK is one of the leading manufacturers of intelligent sensors and sensor solutions for industrial applications. A unique range of products and services creates the perfect basis for controlling processes securely and efficiently, protecting individuals from accidents and preventing damage to the environment.

We have extensive experience in a wide range of industries and understand their processes and requirements. With intelligent sensors, we can deliver exactly what our customers need. In application centers in Europe, Asia and North America, system solutions are tested and optimized in accordance with customer specifications. All this makes us a reliable supplier and development partner.

Comprehensive services complete our offering: SICK LifeTime Services provide support throughout the machine life cycle and ensure safety and productivity.

For us, that is “Sensor Intelligence.”

WORLDWIDE PRESENCE:

Contacts and other locations –www.sick.com