



# UFS3-37N517

UFS

**FORK SENSORS**

**SICK**  
Sensor Intelligence.



Illustration may differ

### Ordering information

Type	Part no.
UFS3-37N517	6075478

Other models and accessories → [www.sick.com/UFS](http://www.sick.com/UFS)



### Detailed technical data

#### Features

<b>Functional principle</b>	Ultrasonic detection principle
<b>Dimensions (W x H x D)</b>	20 mm x 37.4 mm x 70 mm
<b>Housing design</b>	Fork shaped
<b>Fork width</b>	2.6 mm
<b>Fork depth</b>	42.5 mm
<b>Minimum detectable object (MDO)</b>	Label size: 2 mm <sup>1)</sup> Label gap: 1 mm <sup>1)</sup>
<b>Label detection</b>	✓
<b>Adjustment</b>	Teach-in button, cable (Teach-in, sensitivity, light/dark switching, Teach-in dynamic)
<b>Teach-in mode</b>	1-point teach-in 2-point teach-in Teach-in dynamic

<sup>1)</sup> Depends on the label thickness.

#### Mechanics/electronics

<b>Supply voltage</b>	10 V DC ... 30 V DC <sup>1)</sup>
<b>Ripple</b>	< 10 % <sup>2)</sup>
<b>Current consumption</b>	50 mA <sup>3)</sup>
<b>Switching frequency</b>	1.1 kHz <sup>4)</sup>
<b>Response time</b>	440 μs <sup>5)</sup>

<sup>1)</sup> Limit values, reverse-polarity protected, operation in short-circuit protected network: max. 8 A.

<sup>2)</sup> May not fall below or exceed  $U_V$  tolerances.

<sup>3)</sup> Without load.

<sup>4)</sup> With light/dark ratio 1:1.

<sup>5)</sup> Signal transit time with resistive load.

<sup>6)</sup> Output current minimal 0.03 mA.

<sup>7)</sup> Reference voltage DC 50 V.

<b>Jitter</b>	40 µs
<b>Switching output</b>	NPN
<b>Switching output (voltage)</b>	NPN: HIGH = $V_S$ / LOW $\leq 3$ V
<b>Switching mode</b>	Light/dark switching
<b>Output current <math>I_{max}</math></b>	100 mA <sup>6)</sup>
<b>Input, teach-in (ET)</b>	Teach: $U < 2$ V: Run: $U = 10$ V ... $< U_V$
<b>Initialization time</b>	100 ms
<b>Connection type</b>	Cable with M12 male connector, 4-pin, 0.31 m
<b>Cable diameter</b>	Ø 3.5 mm
<b>Protection class</b>	III <sup>7)</sup>
<b>Circuit protection</b>	$U_V$ connections, reverse polarity protected Output Q short-circuit protected Interference pulse suppression
<b>Enclosure rating</b>	IP65
<b>Weight</b>	Approx. 100 g
<b>Housing material</b>	Zamak Glass fiber reinforced plastic
<b>Indication</b>	LED indicator green: power on LED indicator, yellow: Status switching output Q

<sup>1)</sup> Limit values, reverse-polarity protected, operation in short-circuit protected network: max. 8 A.

<sup>2)</sup> May not fall below or exceed  $U_V$  tolerances.

<sup>3)</sup> Without load.

<sup>4)</sup> With light/dark ratio 1:1.

<sup>5)</sup> Signal transit time with resistive load.

<sup>6)</sup> Output current minimal 0.03 mA.

<sup>7)</sup> Reference voltage DC 50 V.

## Communication interface

<b>IO-Link</b>	✓, V1.1
Data transmission rate	COM3 (230,4 kBaud)
Cycle time	4 ms
VendorID	26
DeviceID HEX	0x8002A6
DeviceID DEC	8389286
Process data length	16 Bit
<b>Process data structure A</b>	Bit 0 = switching signal $Q_{L1}$ Bit 1 = switching signal $Q_{L2}$ Bit 2 = switching signal $Q_{Int1}$ Bit 3 = switching signal $Q_{Int2}$ Bit 4 = alarm QoR Bit 5 = Teach busy Bit 6 ... 15 = measured value
<b>Digital output</b>	$Q_1$
Number	1

### Ambient data

<b>Ambient operating temperature</b>	+5 °C ... +55 °C <sup>1)</sup>
<b>Ambient temperature, storage</b>	-20 °C ... +70 °C
<b>Shock load</b>	According to EN 60068-2-27
<b>EMC</b>	EN 60947-5-2 <sup>2)</sup>
<b>UL File No.</b>	NRKH.E191603 & NRKH7.E191603

<sup>1)</sup> Do not bend below 0 °C.

<sup>2)</sup> The sensor complies with the Radio Safety Requirements (EMC) for the industrial sector (Radio Safety Class A). It may cause radio interference if used in a residential area.

### Connection type/pinouts

<b>Connection type</b>	Cable with M12 male connector, 4-pin, 0.31 m
<b>Connection type Detail</b>	
Cable diameter	Ø 3.5 mm
Conductor cross section	0.14 mm <sup>2</sup>
Cable material	PVC
Length of cable	0.265 m
Length of male connector	4.5 cm
<b>Pinouts</b>	
BN 1	+ (L+)
WH 2	MF
BU 3	- (M)
BK 4	Q/C

### Smart Task

<b>Smart Task name</b>	Base logics
------------------------	-------------

### Classifications

<b>ECLASS 5.0</b>	27270909
<b>ECLASS 5.1.4</b>	27270909
<b>ECLASS 6.0</b>	27270909
<b>ECLASS 6.2</b>	27270909
<b>ECLASS 7.0</b>	27270909
<b>ECLASS 8.0</b>	27270909
<b>ECLASS 8.1</b>	27270909
<b>ECLASS 9.0</b>	27270909
<b>ECLASS 10.0</b>	27270909
<b>ECLASS 11.0</b>	27270909
<b>ECLASS 12.0</b>	27270909
<b>ETIM 5.0</b>	EC002720
<b>ETIM 6.0</b>	EC002720
<b>ETIM 7.0</b>	EC002720
<b>ETIM 8.0</b>	EC002720
<b>UNSPSC 16.0901</b>	39121528

**Dimensional drawing** (Dimensions in mm (inch))

Dimensional drawing, sensor

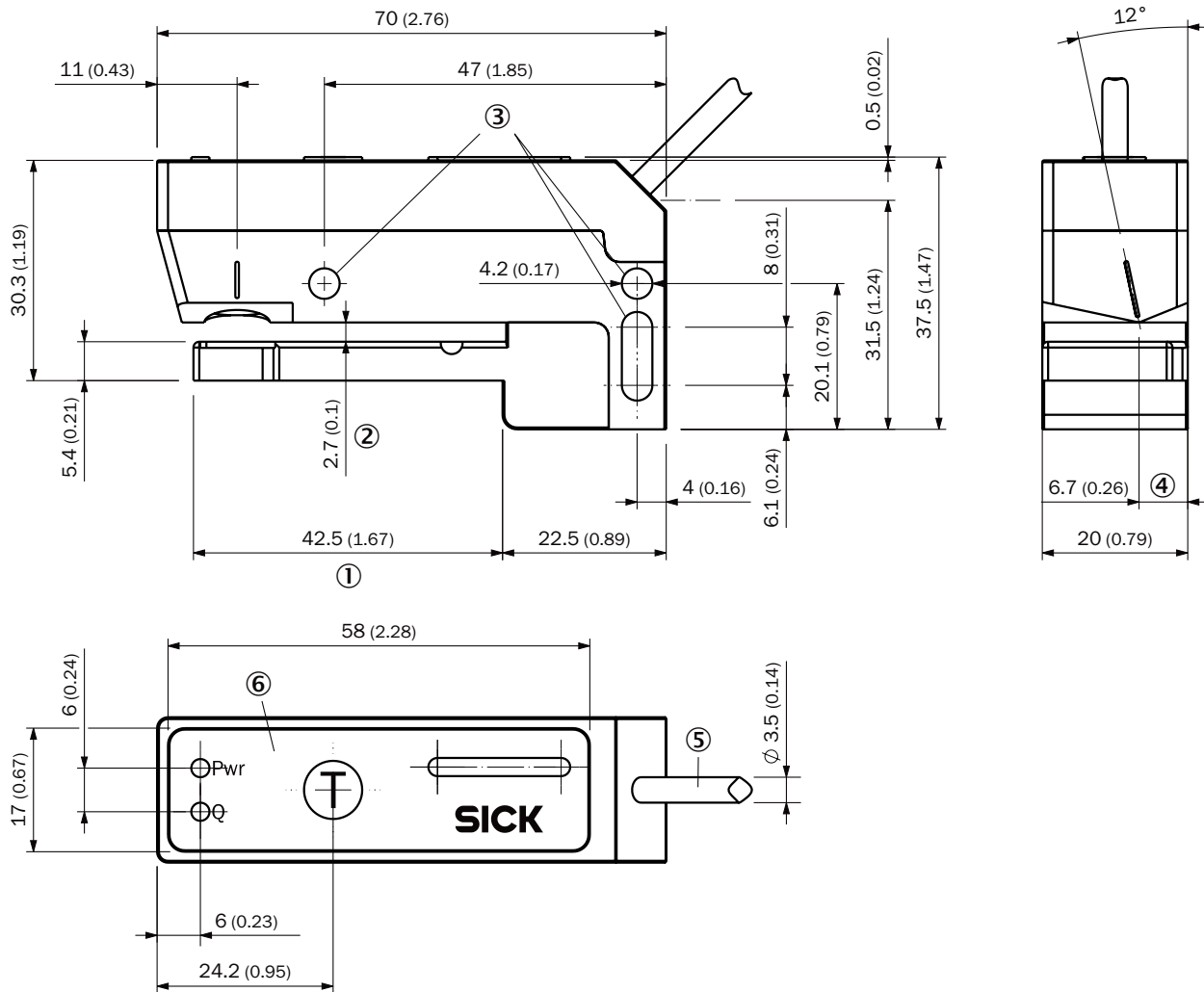

- ① Fork depth
- ② Fork width
- ③ Fixing hole
- ④ Detection axis
- ⑤ Connection (see technical data for length of cable)
- ⑥ Display and adjustment elements

Dimensional drawing, connection type

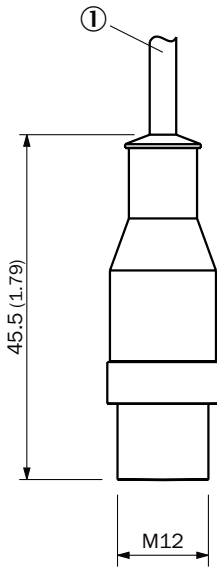

Cable with M12 male connector

① Connection (see technical data for length of cable)

### Pinouts

Pinouts, see table Technical data: **Connection type/pinouts**

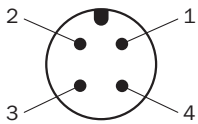

M12 male connector, 4-pin, A-coding

### Adjustments

Display and adjustment elements

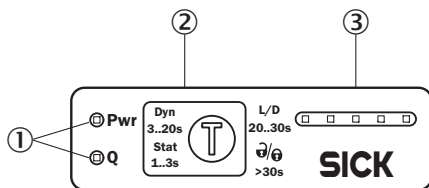





① LEDs (status display)

② Teach-in button

③ Bar graph

## Recommended accessories

Other models and accessories → [www.sick.com/UFS](http://www.sick.com/UFS)

	Brief description	Type	Part no.
<b>Connection modules</b>			
	IO-Link V1.1 Class A port, USB2.0 port, optional external power supply 24V / 1A	IOLA2US-01101 (SiLink2 Master)	1061790
<b>Universal bar clamp systems</b>			
	WFS mounting rod, straight, including 2 x fixing screws, Aluminum	BEF-M12GF-A	2059414
	Bar clamp for bar diameter of 12 mm (fixing the mounting rod), Aluminum, 2 screws M6 x 30, 2 spring discs	BEF-RMC-D12	5321878
	<ul style="list-style-type: none"> <li>• <b>Connection type head A:</b> Female connector, M12, 4-pin, straight, A-coded</li> <li>• <b>Connection type head B:</b> Flying leads</li> <li>• <b>Signal type:</b> Sensor/actuator cable</li> <li>• <b>Cable:</b> 5 m, 4-wire, PVC</li> <li>• <b>Description:</b> Sensor/actuator cable, unshielded</li> <li>• <b>Application:</b> Zones with chemicals</li> </ul>	YF2A14-050VB3XLEAX	2096235
<b>Sensor Integration Gateway</b>			
	<ul style="list-style-type: none"> <li>• <b>Further functions:</b> Web server integrated, IIoT interface available (dual talk)</li> <li>• <b>Logic editor:</b> no</li> <li>• <b>Communication interface:</b> IO-Link, Ethernet, PROFINET, REST API, MQTT, OPC UA</li> <li>• <b>Product category:</b> IO-Link Master</li> </ul>	SIG350-0004AP100	6076871
	<ul style="list-style-type: none"> <li>• <b>Further functions:</b> Web server integrated, IIoT interface available (dual talk)</li> <li>• <b>Logic editor:</b> no</li> <li>• <b>Communication interface:</b> IO-Link, Ethernet, EtherNet/IP™, REST API, MQTT, OPC UA</li> <li>• <b>Product category:</b> IO-Link Master</li> </ul>	SIG350-0005AP100	6076923
	<ul style="list-style-type: none"> <li>• <b>Further functions:</b> Web server integrated, IIoT interface available (dual talk)</li> <li>• <b>Logic editor:</b> no</li> <li>• <b>Communication interface:</b> IO-Link, Ethernet, EtherCAT®, REST API, MQTT, OPC UA</li> <li>• <b>Product category:</b> IO-Link Master</li> </ul>	SIG350-0006AP100	6076924

## SICK AT A GLANCE

SICK is one of the leading manufacturers of intelligent sensors and sensor solutions for industrial applications. A unique range of products and services creates the perfect basis for controlling processes securely and efficiently, protecting individuals from accidents and preventing damage to the environment.

We have extensive experience in a wide range of industries and understand their processes and requirements. With intelligent sensors, we can deliver exactly what our customers need. In application centers in Europe, Asia and North America, system solutions are tested and optimized in accordance with customer specifications. All this makes us a reliable supplier and development partner.

Comprehensive services complete our offering: SICK LifeTime Services provide support throughout the machine life cycle and ensure safety and productivity.

For us, that is “Sensor Intelligence.”

## WORLDWIDE PRESENCE:

Contacts and other locations –[www.sick.com](http://www.sick.com)