



UM18-21212B211

UM18

ULTRASONIC DISTANCE SENSORS

SICK
Sensor Intelligence.



Ordering information

Type	Part no.
UM18-21212B211	6066174

Other models and accessories → www.sick.com/UM18



Detailed technical data

Features

Operating range, limiting range	65 mm ... 350 mm, 600 mm
Target	Natural objects
Resolution	≥ 0.069 mm
Repeatability	± 0.15 % ¹⁾
Measurement accuracy	± 1 % ^{2) 3)}
Temperature compensation	✓
Response time	64 ms
Switching frequency	12 Hz
Output time	16 ms
Ultrasonic frequency (typical)	400 kHz
Additional function	Adjustable operating modes: Switching point (DtO) / Switching window/Background (ObSB), teach-in of digital output, invertible digital output, teach-in of analog output, Invertible analog output, multifunctional input: external teach / synchronization / multiplexing, synchronization of up to 20 sensors, multiplexing: no cross talk of up to 20 sensors, reset to factory default
Safety-related parameters	
	MTTF _D 101 years
	DC _{avg} 0%

¹⁾ In relation to the current measured value, minimum value ≥ resolution.

²⁾ Referring to current measurement value.

³⁾ Temperature compensation can be switched off, without temperature compensation: 0.17 % / K.

Interfaces

IO-Link	✓, IO-Link V1.1
Function	Process data, parameterization, diagnosis, data storage
Digital output	

¹⁾ Push-pull: PNP/NPN HIGH = U_V - (< 3 V) / LOW < 3 V.

Number	1 ¹⁾
Type	Push-pull: PNP/NPN
Maximum output current I _A	≤ 100 mA
Multifunctional input (MF)	1 x MF
Hysteresis	5 mm

¹⁾ Push-pull: PNP/NPN HIGH = U_V - (< 3 V) / LOW < 3 V.

Electronics

Supply voltage U_B	DC 10 V ... 30 V ¹⁾
Power consumption	≤ 1.2 W ²⁾
Initialization time	< 300 ms
Indication	2 x LED
Enclosure rating	IP65 / IP67
Protection class	III

¹⁾ Limit values, reverse-polarity protected Operation in short-circuit protected network: max. 8 A, class 2.

²⁾ Without load.

Mechanics

Dimensions (W x H x D)	18 mm x 18 mm x 52.7 mm
Design	Cylindrical
Sending axis	Straight
Housing material	Metal (nickel-plated brass, ultrasonic transducer: polyurethane foam, glass epoxy resin)
Weight	25 g
Thread size	M18 x 1
Connection type	Male connector, M12, 5-pin

Ambient data

Ambient temperature, operation	-25 °C ... +70 °C
Ambient temperature, storage	-40 °C ... +85 °C

Classifications

ECLASS 5.0	27270804
ECLASS 5.1.4	27270804
ECLASS 6.0	27270804
ECLASS 6.2	27270804
ECLASS 7.0	27270804
ECLASS 8.0	27270804
ECLASS 8.1	27270804
ECLASS 9.0	27270804
ECLASS 10.0	27270804
ECLASS 11.0	27270804
ECLASS 12.0	27272806
ETIM 5.0	EC001846
ETIM 6.0	EC001846

ETIM 7.0	EC001846
ETIM 8.0	EC001846
UNSPSC 16.0901	411111960

Dimensional drawing (Dimensions in mm (inch))

UM18-2xxxxx1

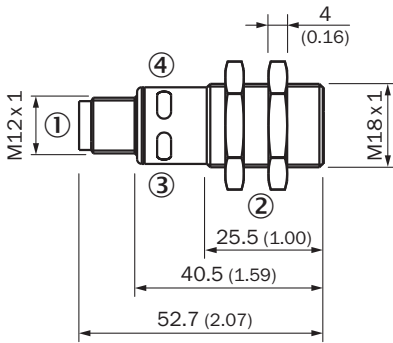

- ① Connection
- ② Fixing nuts, width 24 mm
- ③ Status display for supply voltage active (green)
- ④ Status indicator switching/analog output (orange)

Connection type

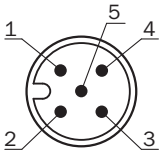

Connection diagram

UM18-21xxxAxxx_Bxxx, male connector M12, 5-pin

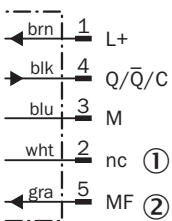

- ① Not assigned
- ② Multifunctional input/synchronization and multiplex operation/communication Connect+

Detection area

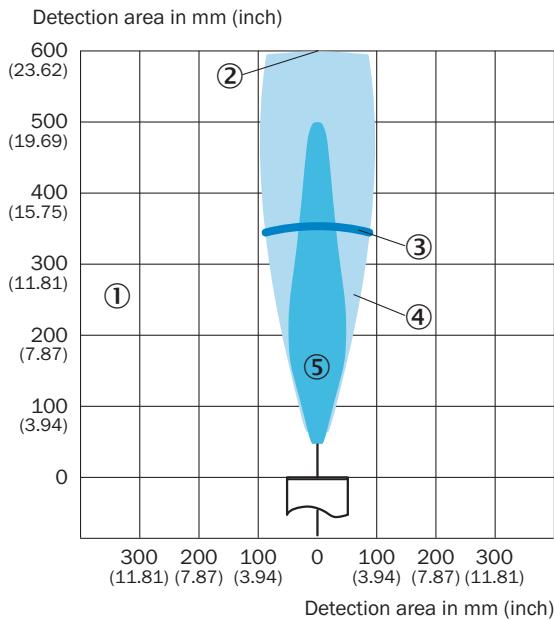

UM18-212



- ① Detection range dependent on reflection properties, size, and alignment of the object
- ② Limiting range
- ③ Operating range
- ④ Example object: aligned plate 500 mm x 500 mm
- ⑤ Example object: pipe with 27 mm diameter

Recommended accessories

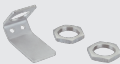
Other models and accessories → www.sick.com/UM18

	Brief description	Type	Part no.
Connection modules			
	IO-Link V1.1 Class A port, USB2.0 port, optional external power supply 24V / 1A	IOLA2US-01101 (SiLink2 Master)	1061790
Deflector mirrors			
	90° sound deflection plate for UM18-1xxxx and UM18-2xxxx, stainless steel, for straight versions	USP-UM18	5323658
Mounting brackets and plates			
	Mounting plate for M18 sensors, steel, zinc coated, without mounting hardware	BEF-WG-M18	5321870
	<ul style="list-style-type: none"> • Connection type head A: Female connector, M12, 5-pin, straight, A-coded • Connection type head B: Flying leads • Signal type: Sensor/actuator cable • Cable: 2 m, 5-wire, PVC • Description: Sensor/actuator cable, unshielded • Application: Zones with chemicals 	YF2A15-020VB5XLEAX	2096239

SICK AT A GLANCE

SICK is one of the leading manufacturers of intelligent sensors and sensor solutions for industrial applications. A unique range of products and services creates the perfect basis for controlling processes securely and efficiently, protecting individuals from accidents and preventing damage to the environment.

We have extensive experience in a wide range of industries and understand their processes and requirements. With intelligent sensors, we can deliver exactly what our customers need. In application centers in Europe, Asia and North America, system solutions are tested and optimized in accordance with customer specifications. All this makes us a reliable supplier and development partner.

Comprehensive services complete our offering: SICK LifeTime Services provide support throughout the machine life cycle and ensure safety and productivity.

For us, that is “Sensor Intelligence.”

WORLDWIDE PRESENCE:

Contacts and other locations –www.sick.com