



UP56-2131A8

UP56

LEVEL SENSORS

**SICK**  
Sensor Intelligence.



### Ordering information

Type	Part no.
UP56-2131A8	6054784

Other models and accessories → [www.sick.com/UP56](http://www.sick.com/UP56)



### Detailed technical data

#### Features

<b>Medium</b>	Fluids, bulk solids
<b>Measurement</b>	Switch, Continuous
<b>Measuring range in tank</b>	200 mm ... 1,300 mm
<b>Measuring range immersion tube</b>	200 mm ... 5,000 mm
<b>Process pressure</b>	0 bar ... 6 bar Gauge pressure
<b>Process temperature</b>	-25 °C ... +70 °C

#### Performance

<b>Accuracy of sensor element</b>	≤ 2 % <sup>1)</sup>
<b>Reproducibility</b>	± 0.15 % <sup>1)</sup>
<b>Resolution</b>	≤ 0.18 mm
<b>Response time</b>	≤ 180 ms <sup>2)</sup>
<b>MTTF</b>	> 100 years
<b>Display</b>	✓

<sup>1)</sup> From the full scale value.

<sup>2)</sup> Recovery time 32 ms ... 180 ms according to EMC EN 60947-5-7.

#### Electronics

<b>Supply voltage</b>	9 V DC ... 30 V DC <sup>1)</sup>
<b>Residual ripple</b>	± 10 %
<b>Power consumption</b>	≤ 80 mA <sup>2)</sup>
<b>Protection class</b>	III

<sup>1)</sup> Reverse-polarity protected.

<sup>2)</sup> At 24 V DC without output load.

<sup>3)</sup> Short-circuit protected, reversible.

<sup>4)</sup> Automatic switching between voltage and current outputs dependet on load 4 mA ... 20 mA: RL ≤ 100 / at 9 V ≤ U<sub>B</sub> ≤ 20 V; RL ≤ 500/ at U<sub>B</sub> ≥ 20 V; 0 V ... 10 V: RL ≥ 100 k / at U<sub>B</sub> ≥ 15 V, short-circuit protected.

<b>Connection type</b>	Round connector M12 x 1, 5-pin
<b>Output signal</b>	1 x PNP + 4 mA ... 20 mA / 0 V ... 10 V <sup>3) 4)</sup>
<b>Hysteresis</b>	20 mm
<b>Output current</b>	200 mA
<b>Time delay before availability</b>	≤ 300 ms
<b>Enclosure rating</b>	IP67
<b>Ultrasonic frequency</b>	180 kHz
<b>Ultrasonic transducer</b>	PTFE coating, FFKM

<sup>1)</sup> Reverse-polarity protected.

<sup>2)</sup> At 24 V DC without output load.

<sup>3)</sup> Short-circuit protected, reversible.

<sup>4)</sup> Automatic switching between voltage and current outputs dependet on load 4 mA ... 20 mA: RL ≤ 100 / at 9 V ≤ U<sub>B</sub> ≤ 20 V; RL ≤ 500/ at U<sub>B</sub> ≥ 20 V; 0 V ... 10 V: RL ≥ 100 k / at U<sub>B</sub> ≥ 15 V, short-circuit protected.

## Mechanics

<b>Process connection</b>	1" NPT
<b>Housing material</b>	Stainless steel 1.4571, PBT, TPU, FKM
<b>Housing design</b>	Standard
<b>Weight</b>	+ 350 g

## Ambient data

<b>Ambient operating temperature</b>	-25 °C ... +70 °C <sup>1)</sup>
<b>Ambient temperature, storage</b>	-40 °C ... +85 °C

<sup>1)</sup> Temperature compensation at -25 °C ... +50 °C, can be switched off.

## Classifications

<b>ECLASS 5.0</b>	27200506
<b>ECLASS 5.1.4</b>	27200506
<b>ECLASS 6.0</b>	27200506
<b>ECLASS 6.2</b>	27200506
<b>ECLASS 7.0</b>	27200506
<b>ECLASS 8.0</b>	27200506
<b>ECLASS 8.1</b>	27200506
<b>ECLASS 9.0</b>	27200506
<b>ECLASS 10.0</b>	27200506
<b>ECLASS 11.0</b>	27200506
<b>ECLASS 12.0</b>	27200506
<b>ETIM 5.0</b>	EC001447
<b>ETIM 6.0</b>	EC001447
<b>ETIM 7.0</b>	EC001447
<b>ETIM 8.0</b>	EC001447
<b>UNSPSC 16.0901</b>	41111950

### Type code

#### Coverage

1	30 ... 250 mm
2	85 ... 350 mm
3	200 mm ... 1,300 mm
4	350 mm ... 3,400 mm
6	65 ... 700 mm

#### Connectivity

1	M12 round connector x 1, 5-pin
2	M12 round connector x 1, 4-pin

#### Process connection / Housing

1	G thread, stainless steel 1.4571 / plastic PBT, TPU, with display
2	G thread, stainless steel 1.4571 / stainless steel 1.4571, without display
4	GF connection D40, PTFE / plastic PP without display
5	GF connection D40, PTFE / plastic PP without display / short design (Mini)
7	G thread, PVDF / plastic PBT, TBU, with display
A	NPT thread, stainless steel 1.4571 / plastic PBT, TPU, with display
B	NPT thread, stainless steel 1.4571 / stainless steel 1.4571, without display
C	NPT thread, PVDF / plastic PBT, TPU, with display

#### Output function

2	2 x PNP transistor output
4	2 x NPN transistor output
5	Push-pull: PNP/NPN; IO-Link 1.1 (process data, diagnostics, parameterization, data repository)
6	Analog, current output
8	Analog, current and voltage output + 1 PNP transistor output

UP 56 - 2 1 1

Not all variants of the type code can be combined!

[Dimensional drawing](#) (Dimensions in mm (inch))

UP56-211/ 212/ 213 all-metal

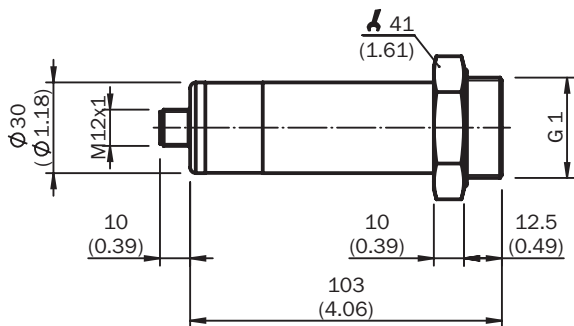

### Connection diagram

1 x PNP + 4 mA ... 20 mA / 0 V ... 10 V

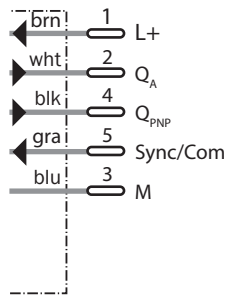

### Connection type

Male connector M12, 5-pin



### Scanning range

Detection range UP56-213118

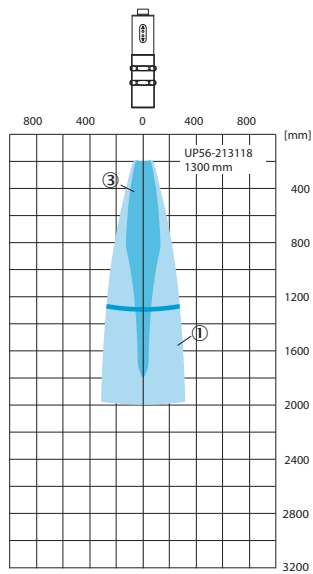





If the points named above are located in the radiation cone, reliable detection is guaranteed

- ① Example object: aligned plate 500 mm x 500 mm
- ③ Pipe diameter 27 mm

### Recommended accessories

Other models and accessories → [www.sick.com/UP56](http://www.sick.com/UP56)

	Brief description	Type	Part no.
Cloning modules			
	Tool for visualization, configuration and cloning, 3-digit LED display, supply voltage: DV 9 V ... 30 V	Connect+ adapter (CPA)	6037782
	<ul style="list-style-type: none"> <li><b>Connection type head A:</b> Female connector, M12, 5-pin, straight, A-coded</li> <li><b>Connection type head B:</b> Flying leads</li> <li><b>Signal type:</b> Sensor/actuator cable</li> <li><b>Cable:</b> 2 m, 5-wire, PUR, halogen-free</li> <li><b>Description:</b> Sensor/actuator cable, unshielded</li> <li><b>Application:</b> Uncontaminated zones, Zones with oils and lubricants, Robot, Drag chain operation</li> </ul>	YF2A15-020UB5XLEAX	2095617
	<ul style="list-style-type: none"> <li><b>Connection type head A:</b> Female connector, M12, 5-pin, straight, A-coded</li> <li><b>Connection type head B:</b> Flying leads</li> <li><b>Signal type:</b> Sensor/actuator cable</li> <li><b>Cable:</b> 2 m, 5-wire, PVC</li> <li><b>Description:</b> Sensor/actuator cable, unshielded</li> <li><b>Application:</b> Zones with chemicals, Uncontaminated zones</li> </ul>	YF2A15-020VB5XLEAX	2096239
	<ul style="list-style-type: none"> <li><b>Connection type head A:</b> Female connector, M12, 5-pin, straight, A-coded</li> <li><b>Connection type head B:</b> Flying leads</li> <li><b>Signal type:</b> Sensor/actuator cable</li> <li><b>Cable:</b> 5 m, 5-wire, PUR, halogen-free</li> <li><b>Description:</b> Sensor/actuator cable, unshielded</li> <li><b>Application:</b> Uncontaminated zones, Zones with oils and lubricants, Robot, Drag chain operation</li> </ul>	YF2A15-050UB5XLEAX	2095618
	<ul style="list-style-type: none"> <li><b>Connection type head A:</b> Female connector, M12, 5-pin, straight, A-coded</li> <li><b>Connection type head B:</b> Flying leads</li> <li><b>Signal type:</b> Sensor/actuator cable</li> <li><b>Cable:</b> 5 m, 5-wire, PVC</li> <li><b>Description:</b> Sensor/actuator cable, unshielded</li> <li><b>Application:</b> Zones with chemicals, Uncontaminated zones</li> </ul>	YF2A15-050VB5XLEAX	2096240
	<ul style="list-style-type: none"> <li><b>Connection type head A:</b> Female connector, M12, 5-pin, straight, A-coded</li> <li><b>Connection type head B:</b> Flying leads</li> <li><b>Signal type:</b> Sensor/actuator cable</li> <li><b>Cable:</b> 10 m, 5-wire, PUR, halogen-free</li> <li><b>Description:</b> Sensor/actuator cable, unshielded</li> <li><b>Application:</b> Uncontaminated zones, Zones with oils and lubricants, Robot, Drag chain operation</li> </ul>	YF2A15-100UB5XLEAX	2095619
	<ul style="list-style-type: none"> <li><b>Connection type head A:</b> Female connector, M12, 5-pin, straight, A-coded</li> <li><b>Connection type head B:</b> Flying leads</li> <li><b>Signal type:</b> Sensor/actuator cable</li> <li><b>Cable:</b> 10 m, 5-wire, PVC</li> <li><b>Description:</b> Sensor/actuator cable, unshielded</li> <li><b>Application:</b> Zones with chemicals, Uncontaminated zones</li> </ul>	YF2A15-100VB5XLEAX	2096241
	<ul style="list-style-type: none"> <li><b>Connection type head A:</b> Female connector, M12, 5-pin, angled, A-coded</li> <li><b>Connection type head B:</b> Flying leads</li> <li><b>Signal type:</b> Sensor/actuator cable</li> <li><b>Cable:</b> 2 m, 5-wire, PUR, halogen-free</li> <li><b>Description:</b> Sensor/actuator cable, unshielded</li> <li><b>Application:</b> Uncontaminated zones, Zones with oils and lubricants, Robot, Drag chain operation</li> </ul>	YG2A15-020UB5XLEAX	2095772
	<ul style="list-style-type: none"> <li><b>Connection type head A:</b> Female connector, M12, 5-pin, angled, A-coded</li> <li><b>Connection type head B:</b> Flying leads</li> <li><b>Signal type:</b> Sensor/actuator cable</li> <li><b>Cable:</b> 2 m, 5-wire, PVC</li> <li><b>Description:</b> Sensor/actuator cable, unshielded</li> <li><b>Application:</b> Zones with chemicals, Uncontaminated zones</li> </ul>	YG2A15-020VB5XLEAX	2096215

	Brief description	Type	Part no.
	<ul style="list-style-type: none"> <li>• <b>Connection type head A:</b> Female connector, M12, 5-pin, angled, A-coded</li> <li>• <b>Connection type head B:</b> Flying leads</li> <li>• <b>Signal type:</b> Sensor/actuator cable</li> <li>• <b>Cable:</b> 5 m, 5-wire, PUR, halogen-free</li> <li>• <b>Description:</b> Sensor/actuator cable, unshielded</li> <li>• <b>Application:</b> Uncontaminated zones, Zones with oils and lubricants, Robot, Drag chain operation</li> </ul>	YG2A15-050UB5XLEAX	2095773
	<ul style="list-style-type: none"> <li>• <b>Connection type head A:</b> Female connector, M12, 5-pin, angled, A-coded</li> <li>• <b>Connection type head B:</b> Flying leads</li> <li>• <b>Signal type:</b> Sensor/actuator cable</li> <li>• <b>Cable:</b> 5 m, 5-wire, PVC</li> <li>• <b>Description:</b> Sensor/actuator cable, unshielded</li> <li>• <b>Application:</b> Zones with chemicals, Uncontaminated zones</li> </ul>	YG2A15-050VB5XLEAX	2096216
	<ul style="list-style-type: none"> <li>• <b>Connection type head A:</b> Female connector, M12, 5-pin, angled, A-coded</li> <li>• <b>Connection type head B:</b> Flying leads</li> <li>• <b>Signal type:</b> Sensor/actuator cable</li> <li>• <b>Cable:</b> 10 m, 5-wire, PUR, halogen-free</li> <li>• <b>Description:</b> Sensor/actuator cable, unshielded</li> <li>• <b>Application:</b> Uncontaminated zones, Zones with oils and lubricants, Robot, Drag chain operation</li> </ul>	YG2A15-100UB5XLEAX	2095774
	<ul style="list-style-type: none"> <li>• <b>Connection type head A:</b> Female connector, M12, 5-pin, angled, A-coded</li> <li>• <b>Connection type head B:</b> Flying leads</li> <li>• <b>Signal type:</b> Sensor/actuator cable</li> <li>• <b>Cable:</b> 10 m, 5-wire, PVC</li> <li>• <b>Description:</b> Sensor/actuator cable, unshielded</li> <li>• <b>Application:</b> Zones with chemicals, Uncontaminated zones</li> </ul>	YG2A15-100VB5XLEAX	2096217

## SICK AT A GLANCE

SICK is one of the leading manufacturers of intelligent sensors and sensor solutions for industrial applications. A unique range of products and services creates the perfect basis for controlling processes securely and efficiently, protecting individuals from accidents and preventing damage to the environment.

We have extensive experience in a wide range of industries and understand their processes and requirements. With intelligent sensors, we can deliver exactly what our customers need. In application centers in Europe, Asia and North America, system solutions are tested and optimized in accordance with customer specifications. All this makes us a reliable supplier and development partner.

Comprehensive services complete our offering: SICK LifeTime Services provide support throughout the machine life cycle and ensure safety and productivity.

For us, that is “Sensor Intelligence.”

## WORLDWIDE PRESENCE:

Contacts and other locations –[www.sick.com](http://www.sick.com)