



UP56-216148

UP56

LEVEL SENSORS

SICK
Sensor Intelligence.



Ordering information

Type	Part no.
UP56-216148	6049450

Other models and accessories → www.sick.com/UP56



Detailed technical data

Features

Medium	Fluids
Measurement	Switch, Continuous
Measuring range in tank	65 mm ... 700 mm
Measuring range immersion tube	65 mm ... 1,500 mm
Process pressure	0 bar ... 6 bar Gauge pressure
Process temperature	-25 °C ... +85 °C

Performance

Accuracy of sensor element	≤ 1 % ¹⁾
Reproducibility	± 0.15 % ¹⁾
Resolution	≤ 0.18 mm
Response time	≤ 84 ms ²⁾
MTTF	> 100 years

¹⁾ From the full scale value.

²⁾ Recovery time 32 ms ... 180 ms according to EMC EN 60947-5-7.

Electronics

Supply voltage	9 V DC ... 30 V DC ¹⁾
Residual ripple	± 10 %
Power consumption	≤ 80 mA ²⁾
Protection class	III
Connection type	Round connector M12 x 1, 5-pin
Output signal	1 x PNP + 4 mA ... 20 mA / 0 V ... 10 V ^{3) 4)}

¹⁾ Reverse-polarity protected.

²⁾ At 24 V DC without output load.

³⁾ Short-circuit protected, reversible.

⁴⁾ Automatic switching between voltage and current outputs dependet on load 4 mA ... 20 mA: RL ≤ 100 / at 9 V ≤ U_B ≤ 20 V; RL ≤ 500/ at U_B ≥ 20 V; 0 V ... 10 V: RL ≥ 100 k / at U_B ≥ 15 V, short-circuit protected.

⁵⁾ Free adjustable in 1 mm steps via Connect+ Adapter (CPA).

Hysteresis	5 mm ⁵⁾
Output current	200 mA
Time delay before availability	≤ 300 ms
Enclosure rating	IP67
Ultrasonic frequency	200 kHz
Ultrasonic transducer	PTFE coating, FFKM

¹⁾ Reverse-polarity protected.

²⁾ At 24 V DC without output load.

³⁾ Short-circuit protected, reversible.

⁴⁾ Automatic switching between voltage and current outputs dependent on load 4 mA ... 20 mA: RL ≤ 100 / at 9 V ≤ U_B ≤ 20 V; RL ≤ 500 / at U_B ≥ 20 V; 0 V ... 10 V: RL ≥ 100 k / at U_B ≥ 15 V, short-circuit protected.

⁵⁾ Free adjustable in 1 mm steps via Connect+ Adapter (CPA).

Mechanics

Process connection	GF connection D40
Housing material	PTFE, PP, FKM
Housing design	Standard
Weight	210 g

Ambient data

Ambient operating temperature	-25 °C ... +70 °C ¹⁾
Ambient temperature, storage	-40 °C ... +85 °C

¹⁾ Temperature compensation at -25 °C ... +50 °C, can be switched off.

Classifications

ECLASS 5.0	27200506
ECLASS 5.1.4	27200506
ECLASS 6.0	27200506
ECLASS 6.2	27200506
ECLASS 7.0	27200506
ECLASS 8.0	27200506
ECLASS 8.1	27200506
ECLASS 9.0	27200506
ECLASS 10.0	27200506
ECLASS 11.0	27200506
ECLASS 12.0	27200506
ETIM 5.0	EC001447
ETIM 6.0	EC001447
ETIM 7.0	EC001447
ETIM 8.0	EC001447
UNSPSC 16.0901	41111950

Type code

Coverage

1	30 ... 250 mm
2	85 ... 350 mm
3	200 mm ... 1,300 mm
4	350 mm ... 3,400 mm
6	65 ... 700 mm

Connectivity

1	M12 round connector x 1, 5-pin
2	M12 round connector x 1, 4-pin

Process connection / Housing

1	G thread, stainless steel 1.4571 / plastic PBT, TPU, with display
2	G thread, stainless steel 1.4571 / stainless steel 1.4571, without display
4	GF connection D40, PTFE / plastic PP without display
5	GF connection D40, PTFE / plastic PP without display / short design (Mini)
7	G thread, PVDF / plastic PBT, TBU, with display
A	NPT thread, stainless steel 1.4571 / plastic PBT, TPU, with display
B	NPT thread, stainless steel 1.4571 / stainless steel 1.4571, without display
C	NPT thread, PVDF / plastic PBT, TPU, with display

Output function

2	2 x PNP transistor output
4	2 x NPN transistor output
5	Push-pull: PNP/NPN; IO-Link 1.1 (process data, diagnostics, parameterization, data repository)
6	Analog, current output
8	Analog, current and voltage output + 1 PNP transistor output

UP 56 - 2 1 1

Not all variants of the type code can be combined!

[Dimensional drawing](#) (Dimensions in mm (inch))

UP56 Pure

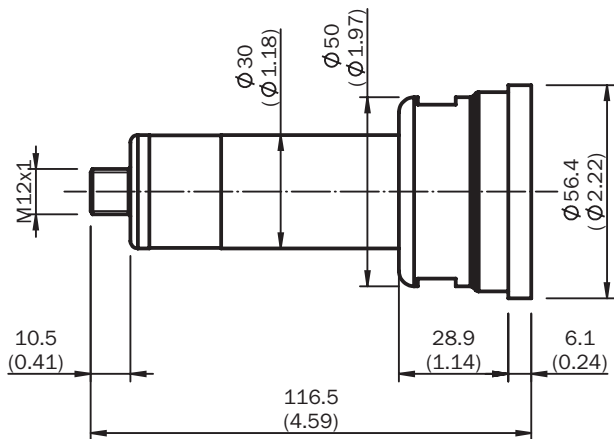

Connection diagram

1 x PNP + 4 mA ... 20 mA / 0 V ... 10 V

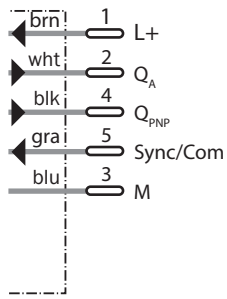

Connection type

Male connector M12, 5-pin



Recommended accessories

Other models and accessories → www.sick.com/UP56

	Brief description	Type	Part no.
Cloning modules			
	Tool for visualization, configuration and cloning, 3-digit LED display, supply voltage: DV 9 V ... 30 V	Connect+ adapter (CPA)	6037782
	<ul style="list-style-type: none"> Connection type head A: Female connector, M12, 5-pin, straight, A-coded Connection type head B: Flying leads Signal type: Sensor/actuator cable Cable: 2 m, 5-wire, PUR, halogen-free Description: Sensor/actuator cable, unshielded Application: Uncontaminated zones, Zones with oils and lubricants, Robot, Drag chain operation 	YF2A15-020UB5XLEAX	2095617
	<ul style="list-style-type: none"> Connection type head A: Female connector, M12, 5-pin, straight, A-coded Connection type head B: Flying leads Signal type: Sensor/actuator cable Cable: 2 m, 5-wire, PVC Description: Sensor/actuator cable, unshielded Application: Zones with chemicals, Uncontaminated zones 	YF2A15-020VB5XLEAX	2096239
	<ul style="list-style-type: none"> Connection type head A: Female connector, M12, 5-pin, straight, A-coded Connection type head B: Flying leads Signal type: Sensor/actuator cable Cable: 5 m, 5-wire, PUR, halogen-free Description: Sensor/actuator cable, unshielded Application: Uncontaminated zones, Zones with oils and lubricants, Robot, Drag chain operation 	YF2A15-050UB5XLEAX	2095618

	Brief description	Type	Part no.
	<ul style="list-style-type: none"> • Connection type head A: Female connector, M12, 5-pin, straight, A-coded • Connection type head B: Flying leads • Signal type: Sensor/actuator cable • Cable: 5 m, 5-wire, PVC • Description: Sensor/actuator cable, unshielded • Application: Zones with chemicals, Uncontaminated zones 	YF2A15-050VB5XLEAX	2096240
	<ul style="list-style-type: none"> • Connection type head A: Female connector, M12, 5-pin, straight, A-coded • Connection type head B: Flying leads • Signal type: Sensor/actuator cable • Cable: 10 m, 5-wire, PUR, halogen-free • Description: Sensor/actuator cable, unshielded • Application: Uncontaminated zones, Zones with oils and lubricants, Robot, Drag chain operation 	YF2A15-100UB5XLEAX	2095619
	<ul style="list-style-type: none"> • Connection type head A: Female connector, M12, 5-pin, straight, A-coded • Connection type head B: Flying leads • Signal type: Sensor/actuator cable • Cable: 10 m, 5-wire, PVC • Description: Sensor/actuator cable, unshielded • Application: Zones with chemicals, Uncontaminated zones 	YF2A15-100VB5XLEAX	2096241
	<ul style="list-style-type: none"> • Connection type head A: Female connector, M12, 5-pin, angled, A-coded • Connection type head B: Flying leads • Signal type: Sensor/actuator cable • Cable: 2 m, 5-wire, PUR, halogen-free • Description: Sensor/actuator cable, unshielded • Application: Uncontaminated zones, Zones with oils and lubricants, Robot, Drag chain operation 	YG2A15-020UB5XLEAX	2095772
	<ul style="list-style-type: none"> • Connection type head A: Female connector, M12, 5-pin, angled, A-coded • Connection type head B: Flying leads • Signal type: Sensor/actuator cable • Cable: 2 m, 5-wire, PVC • Description: Sensor/actuator cable, unshielded • Application: Zones with chemicals, Uncontaminated zones 	YG2A15-020VB5XLEAX	2096215
	<ul style="list-style-type: none"> • Connection type head A: Female connector, M12, 5-pin, angled, A-coded • Connection type head B: Flying leads • Signal type: Sensor/actuator cable • Cable: 5 m, 5-wire, PUR, halogen-free • Description: Sensor/actuator cable, unshielded • Application: Uncontaminated zones, Zones with oils and lubricants, Robot, Drag chain operation 	YG2A15-050UB5XLEAX	2095773
	<ul style="list-style-type: none"> • Connection type head A: Female connector, M12, 5-pin, angled, A-coded • Connection type head B: Flying leads • Signal type: Sensor/actuator cable • Cable: 5 m, 5-wire, PVC • Description: Sensor/actuator cable, unshielded • Application: Zones with chemicals, Uncontaminated zones 	YG2A15-050VB5XLEAX	2096216
	<ul style="list-style-type: none"> • Connection type head A: Female connector, M12, 5-pin, angled, A-coded • Connection type head B: Flying leads • Signal type: Sensor/actuator cable • Cable: 10 m, 5-wire, PUR, halogen-free • Description: Sensor/actuator cable, unshielded • Application: Uncontaminated zones, Zones with oils and lubricants, Robot, Drag chain operation 	YG2A15-100UB5XLEAX	2095774
	<ul style="list-style-type: none"> • Connection type head A: Female connector, M12, 5-pin, angled, A-coded • Connection type head B: Flying leads • Signal type: Sensor/actuator cable • Cable: 10 m, 5-wire, PVC • Description: Sensor/actuator cable, unshielded • Application: Zones with chemicals, Uncontaminated zones 	YG2A15-100VB5XLEAX	2096217

SICK AT A GLANCE

SICK is one of the leading manufacturers of intelligent sensors and sensor solutions for industrial applications. A unique range of products and services creates the perfect basis for controlling processes securely and efficiently, protecting individuals from accidents and preventing damage to the environment.

We have extensive experience in a wide range of industries and understand their processes and requirements. With intelligent sensors, we can deliver exactly what our customers need. In application centers in Europe, Asia and North America, system solutions are tested and optimized in accordance with customer specifications. All this makes us a reliable supplier and development partner.

Comprehensive services complete our offering: SICK LifeTime Services provide support throughout the machine life cycle and ensure safety and productivity.

For us, that is “Sensor Intelligence.”

WORLDWIDE PRESENCE:

Contacts and other locations –www.sick.com