



Ordering information

Type	Part no.
V2D621D-2MSFFB5	1085376

Other models and accessories → www.sick.com/Lector62x



Detailed technical data

Features

Optical focus	Teach auto focus
Sensor	CMOS matrix sensor, grayscale values
Sensor resolution	1,280 px x 1,024 px
Illumination	Integrated
Illumination color	Red, LED, Visible, 617 nm, ± 15 nm Blue, LED, Visible, 470 nm, ± 15 nm
LED class	1 (IEC 62471:2006-07, EN 62471:2008-09)
Feedback spot	LED, Visible, green, 525 nm, ± 15 nm
Alignment aid	Laser, Red, 630 nm ... 680 nm
Laser class	1, Complies with 21 CFR 1040.10 and 1040.11 except for conformance with IEC 60825-1 Ed.3., as described in "Laser Notice No. 56" dated May 8, 2019 (IEC 60825-1:2014, EN 60825-1:2014+A11:2021)
Lens	
Focal length	17.1 mm
Reading distance	300 mm ... 1,500 mm ^{1) 2)}
Scanning frequency	50 Hz
Code resolution	0.25 mm ²⁾

¹⁾ Valid for Data Matrix, PDF417, and 1D codes with good print quality.

²⁾ For details see reading field diagram.

Mechanics/electronics

Connection type	1 x M12, 17-pin male connector 1 x M12, 4-pin Ethernet female connector Circular plug-in connector
------------------------	--

¹⁾ Swivel connector is 17.8 mm longer.

Supply voltage	12 V DC ... 24 V DC, ± 20 %
Power consumption	Typ. 4 W
Housing material	Aluminum die cast
Housing color	Light blue (RAL 5012)
Window material	Plastic
Enclosure rating	IP65 (EN 60529, EN 60529/A2)
Protection class	III
Electrical safety	EN 62368
Weight	170 g
Dimensions (L x W x H)	71 mm x 43 mm x 35.6 mm ¹⁾
MTBF	75,000 h

¹⁾ Swivel connector is 17.8 mm longer.

Performance

Readable code structures	1D codes, Stacked, 2D codes, direct-marked codes, plain text
Bar code types	GS1-128 / EAN 128, UPC / GTIN / EAN, Interleaved 2 of 5, Pharmacode, GS1 DataBar, Code 39, Code 128, Codabar, Code 32, Code 93, Plessey Code, MSI/Plessey, Telepen, postal codes
2D code types	Data Matrix ECC200, GS1 Data-Matrix, PDF417, PDF417 Truncated, QR code, MaxiCode
Code qualification	On the basis of ISO/IEC 16022, ISO/IEC 15415, ISO/IEC 15416, ISO/IEC 18004
No. of codes per reading interval	1 ... 50
No. of characters per reading interval	500 (for multiplexer function in CAN operation)
Automated parameter switching	✓

Interfaces

Ethernet	✓, TCP/IP
Function	Data interface (read result output), Service interface, FTP (image transmission)
Data transmission rate	10/100 MBit/s
PROFINET	✓
Function	PROFINET Single Port, PROFINET Dual Port (optional via external connection module CDF600-2)
Data transmission rate	10/100 MBit/s
EtherNet/IP™	✓
Data transmission rate	10/100 MBit/s
EtherCAT	✓
Type of fieldbus integration	Optional over external fieldbus module CDF600
Serial	✓, RS-232, RS-422
Function	Data interface (read result output), Service interface
Data transmission rate	0.3 kBaud ... 115.2 kBaud, AUX: 57.6 kBaud (RS-232)
CAN	✓
Function	SICK CAN sensor network CSN (CAN controller/CAN device, multiplexer/server)
Data transmission rate	20 kbit/s ... 1 Mbit/s
CANopen	✓
Data transmission rate	20 kbit/s ... 1 Mbit/s
PROFIBUS DP	✓

Type of fieldbus integration	Optional over external fieldbus module CDF600-2
Digital inputs	4 ("Sensor 1", "Sensor 2", 2 inputs via optional parameter storage CMC600 in CDM420)
Digital outputs	4 ("Result 1", "Result 2", 2 outputs via CMC and CDM420 or "Result 1", "Result 2", "Result 3", "Result 4" when using the 17-wire cable with open cable end)
Reading pulse	Digital inputs, non-powered, serial interface, Ethernet, CAN, auto pulse, presentation mode
Optical indicators	16 LEDs (5 x status display, 10 x LED bar graph, 1 green feedback spot)
Acoustic indicators	Beeper/buzzer (can be switched off, can be assigned a function to signal a result)
Control elements	2 buttons (choose and start/stop functions)
Operator interfaces	Web server
Configuration software	SOPAS ET
Memory card	microSD memory card (flash card), optional
Data storage and retrieval	Image and data storage via microSD memory card and external FTP
EncoderFrequency	Max. 300 Hz
External illumination control	Via digital output (max. 24 V trigger)

Ambient data

Electromagnetic compatibility (EMC)	EN 61000-6-2:2005-08 / EN 61000-6-4 (2007-01) + A1 (2011)
Vibration resistance	EN 60068-2-6:2008-02
Shock resistance	EN 60068-2-27:2009-05
Ambient operating temperature	0 °C ... +50 °C
Storage temperature	-20 °C ... +70 °C
Permissible relative humidity	90 %, Non-condensing
Ambient light immunity	2,000 lx, on code

Classifications

ECLASS 5.0	27280103
ECLASS 5.1.4	27280103
ECLASS 6.0	27280103
ECLASS 6.2	27280103
ECLASS 7.0	27280103
ECLASS 8.0	27280103
ECLASS 8.1	27280103
ECLASS 9.0	27280103
ECLASS 10.0	27280103
ECLASS 11.0	27280103
ECLASS 12.0	27280103
ETIM 5.0	EC002550
ETIM 6.0	EC002550
ETIM 7.0	EC002999
ETIM 8.0	EC002999
UNSPSC 16.0901	43211701

Dimensional drawing (Dimensions in mm (inch))

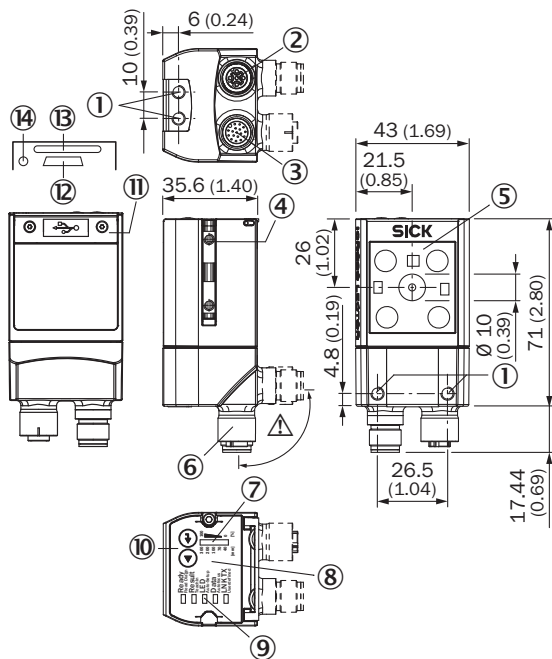

- ① M5 blind tapped holes, 5 mm deep (4 x), for mounting the sensor
- ② "Ethernet" connection, 4-pin M12 female connector, D-coded
- ③ "Power/Serial Data/CAN/I/O" connection, 17-pin M12 male connector, A-coded
- ④ Sliding nut M5, 5.5 mm deep (2 x), for mounting (as alternative)
- ⑤ Reading window with internal illumination LEDs (4 x)
- ⑥ Swivel connector unit
- ⑦ Bar graph
- ⑧ Beeper (under housing cover)
- ⑨ LEDs for status display (2 levels), 5 x
- ⑩ Function button (2 x)
- ⑪ Cover (flap)
- ⑫ "USB" connection (female connector, 5-pin, type Micro-B) interface for temporary use (service)
- ⑬ Slot for microSD memory card
- ⑭ LED for microSD memory card

Field of view

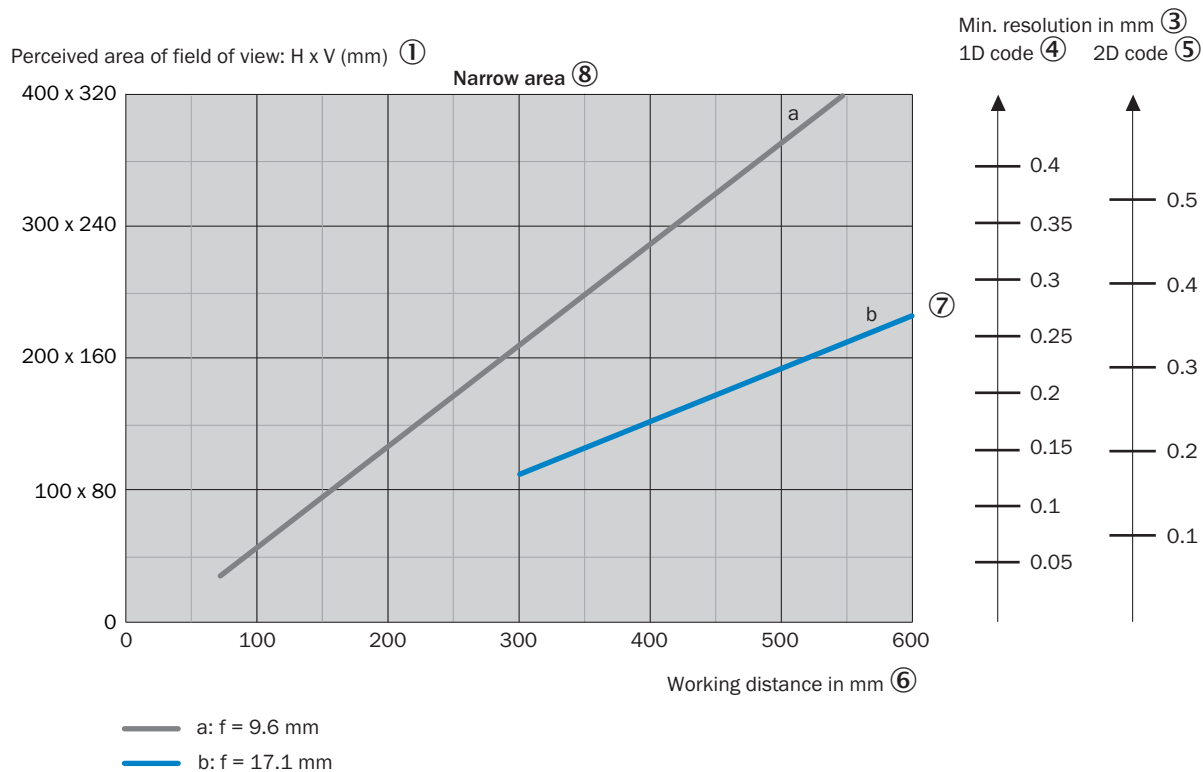
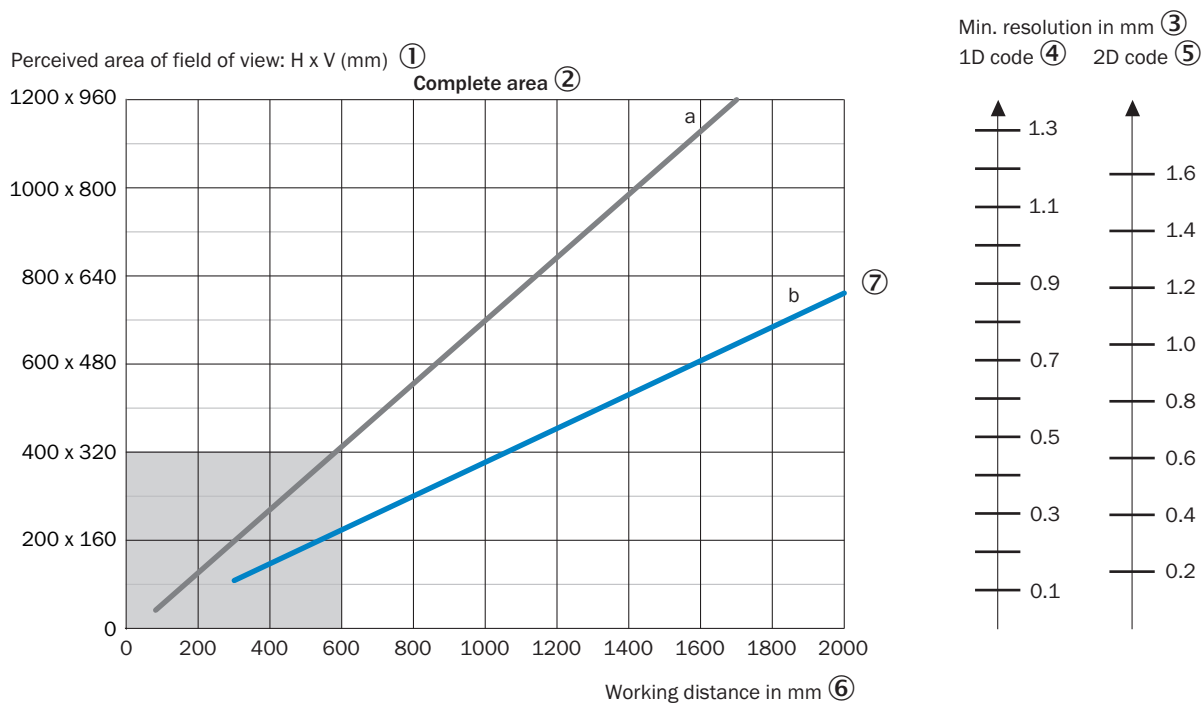







- ① Perceived field of view area: horizontal x vertical (mm)
- ② Complete area
- ③ Minimum resolution in mm
- ④ 1D code
- ⑤ 2D code
- ⑥ Working distance in mm
- ⑦ Focal length of lens, here example for f = 17.1 mm

© Close range

Recommended accessories

Other models and accessories → www.sick.com/Lector62x

	Brief description	Type	Part no.
Modules			
	<ul style="list-style-type: none"> Accessory group: 4DproConnectivity Product family: Connection Device Basic Sub product family: CDB650 Supported products: Lector series CLV62x - CLV64x (depending on type) CLV69xRFID read/write device InspectorP series Brief description: Connection device basic for connecting one sensor with 2 A fuse, 5 cable glands and RS-232 interface to sensor via M12, 17-pin female connector, all outputs available on screw/spring-loaded terminals. 	CDB650-204	1064114
	<ul style="list-style-type: none"> Accessory group: 4DproConnectivity Product family: Connection Device Fieldbus Sub product family: CDF600-2 PROFIBUS DP Supported products: Lector series CLV61x - CLV65xCLV69xRFID read/write device Mobile handheld scanners Brief description: Fieldbus proxy/gateway for connecting identification sensors to PROFIBUS-DP networks (PROFIBUS interface: 2 x M12, male connector/female connector, 5-pin) 	CDF600-2100	1058965
	<ul style="list-style-type: none"> Accessory group: 4DproConnectivity Product family: Connection Device Fieldbus Sub product family: CDF600-2 PROFIBUS DP Supported products: Lector series CLV61x - CLV65xCLV69xRFID read/write device Mobile handheld scanners Brief description: Fieldbus proxy/gateway for connecting identification sensors to PROFIBUS-DP networks (PROFIBUS interface: 1 x D-Sub, female connector, 9-pin) 	CDF600-2103	1058966
Mounting brackets and plates			
	Bracket with adapter board	Mounting bracket	2042902
Others			
	<ul style="list-style-type: none"> Connection type head A: Male connector, Micro-B, 4-pin, straight Connection type head B: Male connector, USB-A, 4-pin, straight Signal type: USB 2.0 Cable: 2 m, 4-wire Description: USB 2.0, unshielded 	USB cable	6036106
	<ul style="list-style-type: none"> Connection type head A: Male connector, M12, 4-pin, straight, D-coded Connection type head B: Male connector, RJ45, 4-pin, straight Signal type: Ethernet, PROFINET Cable: 2 m, 4-wire, PUR, halogen-free Description: Ethernet, PROFINET, shielded Application: Drag chain operation, Zones with oils and lubricants 	YM2D24-020PN1MRJA4	2106182

Recommended services

Additional services → www.sick.com/Lector62x

	Type	Part no.
Performance check		
<ul style="list-style-type: none"> • Product area: Image-based code readers • Range of services: Inspection of defined functions, e.g., reading performance • Duration: Additional work will be invoiced separately 	Performance check Lector	1608207
Maintenance		
<ul style="list-style-type: none"> • Product area: Image-based code readers • Range of services: Inspection, analysis and restoring of defined functions, Inspection and adaptation of previously defined functions of possible Lector6xx illumination, code configuration, trigger and digital inputs, interfaces and digital outputs as well as data processing • Duration: Additional work will be invoiced separately 	Maintenance Lector	1611421
Commissioning		
<ul style="list-style-type: none"> • Product area: Image-based code readers • Range of services: Inspection of connection, fine adjustment, optimization of parameters of SICK product as well as tests, Set-up of previously defined functions of possible illumination, code configuration, trigger and digital inputs, interfaces and digital outputs as well as data processing • Duration: Additional work will be invoiced separately 	Commissioning Lector	1608206
Extended warranty		
<ul style="list-style-type: none"> • Product area: Machine vision, LiDAR sensors, safety camera sensors, Safety laser scanners, Safety radar sensors, Radar sensors, Fixed mount barcode scanners, Image-based code readers, RFID, Mobile handheld scanners • Range of services: The services correspond to the scope of the statutory manufacturer warranty (SICK general terms of delivery). • Duration: Five-year warranty from delivery date. 	Extended warranty for a total of five years from delivery date	1680671

SICK AT A GLANCE

SICK is one of the leading manufacturers of intelligent sensors and sensor solutions for industrial applications. A unique range of products and services creates the perfect basis for controlling processes securely and efficiently, protecting individuals from accidents and preventing damage to the environment.

We have extensive experience in a wide range of industries and understand their processes and requirements. With intelligent sensors, we can deliver exactly what our customers need. In application centers in Europe, Asia and North America, system solutions are tested and optimized in accordance with customer specifications. All this makes us a reliable supplier and development partner.

Comprehensive services complete our offering: SICK LifeTime Services provide support throughout the machine life cycle and ensure safety and productivity.

For us, that is “Sensor Intelligence.”

WORLDWIDE PRESENCE:

Contacts and other locations –www.sick.com