



V2D642P-2MCXXA6

InspectorP64x

2D MACHINE VISION

SICK
Sensor Intelligence.



Ordering information

Type	Part no.
V2D642P-2MCXXA6	1082302

Other models and accessories → www.sick.com/InspectorP64x



Detailed technical data

Features

Technology	2D snapshot
Product category	Programmable
SensorApp	Nova Inspector
License included	Quality Inspection License Optional upgrade with the Intelligent Inspection Upgrade License, which enables productive use of the complete toolset.
Sensor	CMOS matrix sensor, grayscale values
Shutter technology	Global-Shutter
Optical focus	Adjustable focus
Illumination	To be ordered separately as accessories
Alignment aid	Laser, Red, 630 nm ... 680 nm
Laser class	1, complies with 21 CFR 1040.10 except for the conformance according to "Laser Notice No. 50" from June 24, 2007 (IEC 60825-1:2014, EN 60825-1:2014)
Spectral range	Approx. 400 nm ... 900 nm
Lens	C-mount
	Optical format 2/3"
	Note To be ordered separately as accessories
Task	Detecting - Standard objects Measuring - Dimension, contour and volume Measuring - Number Identifying - 2D code Identifying - OCR Identifying - Pattern Identifying - Classifying Identifying - Sorting Determining position - 2D position determination

Mechanics/electronics

Connection type	1 x M12, 17-pin male connector (serial, I/Os, voltage supply) 1 x M8, 4-pin female connector (USB, not used) 2 x M12, 8-pin female connector (Gigabit Ethernet, only one connection used)
Supply voltage	24 V DC, $\pm 20\%$
Power consumption	Typ. 20 W, $\pm 20\%$
Enclosure rating	IP65 (EN 60529 (1991-10), EN 60529/A2 (2002-02))
Protection class	III
Housing material	Aluminum die cast
Window material	Glass
Weight	635 g
Dimensions (L x W x H)	142 mm x 90 mm x 46 mm ¹⁾

¹⁾ Housing only, without lens and optics protection hood.

Performance

Sensor resolution	1,600 px x 1,088 px (1.7 Mpixel)
Scan/frame rate	40 Hz

Interfaces

Serial	✓, RS-232, RS-422
Data transmission rate	300 Baud ... 115.2 kBaud
Ethernet	✓, TCP/IP
Function	FTP, HTTP
Data transmission rate	10/100/1,000 Mbit/s
CAN	✓
Function	SICK CAN sensor network (CAN controller/CAN device)
EtherNet/IP™	✓
Data transmission rate	10/100/1,000 Mbit/s
PROFINET	✓
Function	PROFINET Single Port, PROFINET Dual Port (optional via external connection module CDF600-2)
Data transmission rate	10/100 MBit/s
Operator interfaces	Web server
Configuration software	SICK AppStudio
Data storage and retrieval	Image and data logging via microSD memory card and external FTP
Inputs/outputs	2 opto-decoupled inputs, 4 inputs/outputs, configurable
Output current	≤ 100 mA
Maximum encoder frequency	1 kHz
External illumination	Via digital output (max. 24 V trigger)
Control elements	2 buttons
Optical indicators	21 LEDs (10 x status display, 10 x LED bar graph, 1 green feedback spot)
Acoustic indicators	Beeper

Ambient data

Shock load	EN 60068-2-27:2009-05
Vibration load	EN 60068-2-6:2008-02
Ambient operating temperature	0 °C ... +50 °C ¹⁾
Storage temperature	-20 °C ... +70 °C ¹⁾

¹⁾ Permissible relative humidity: 0% ... 90% (non-condensing).

Classifications

ECLASS 5.0	27310205
ECLASS 5.1.4	27310205
ECLASS 6.0	27310205
ECLASS 6.2	27310205
ECLASS 7.0	27310205
ECLASS 8.0	27310205
ECLASS 8.1	27310205
ECLASS 9.0	27310205
ECLASS 10.0	27310205
ECLASS 11.0	27310205
ECLASS 12.0	27310205
ETIM 5.0	EC001820
ETIM 6.0	EC001820
ETIM 7.0	EC001820
ETIM 8.0	EC001820
UNSPSC 16.0901	43211731

Dimensional drawing (Dimensions in mm (inch))

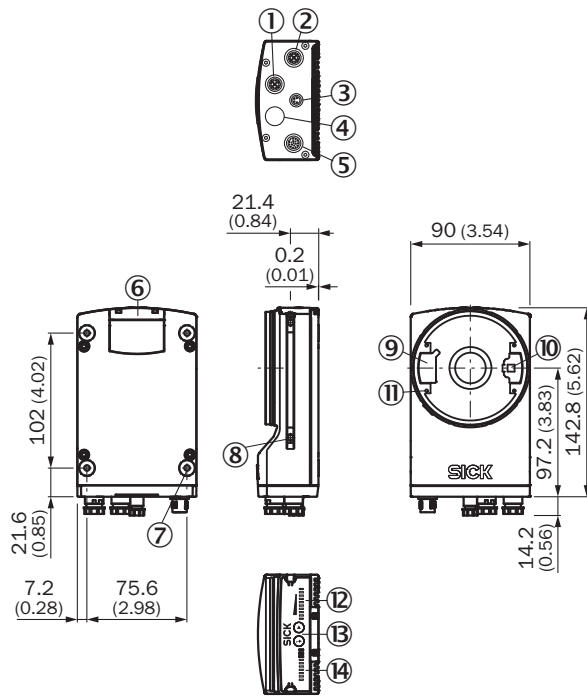

- ① "Ethernet" P1 connection
- ② P3 connection "Ethernet"
- ③ X2 "USB" connection or "trigger external lighting", depending on type
- ④ P2 connection "CAN OUT", depending on type
- ⑤ X1 "Power/Serial Data/CAN/I/O" connection or "CAN IN", depending on type
- ⑥ Cover for the microSD memory card
- ⑦ M5 blind tapped holes, 5 mm deep (4 x), for mounting the sensor
- ⑧ Sliding nut M5, 5.5 mm deep (2 x), for mounting (as alternative)
- ⑨ Plug connector for connecting the integrated lighting
- ⑩ Laser alignment aid exit
- ⑪ 2.5 mm blind tapped holes (4 x) for mounting the spacers for the integrable illumination
- ⑫ Bar graph display
- ⑬ Function button (2 x)
- ⑭ LED for status display (2 levels), 10 x

Field of view

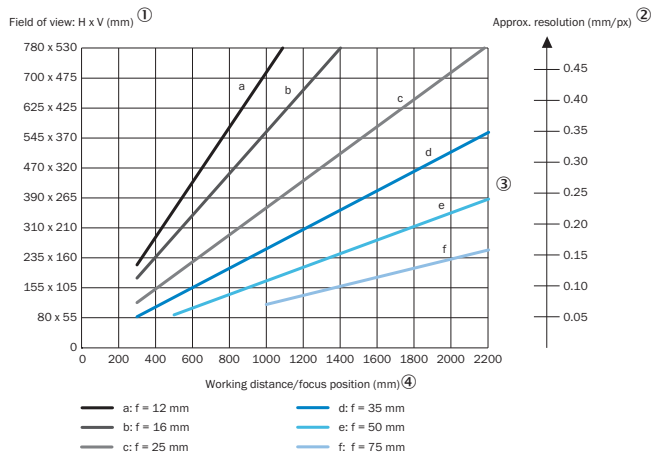

- ① Field of view: Horizontal x vertical in mm
- ② Approximate resolution in mm/px
- ③ Lens focal length
- ④ Working distance/Focus position in mm

Selection Guide

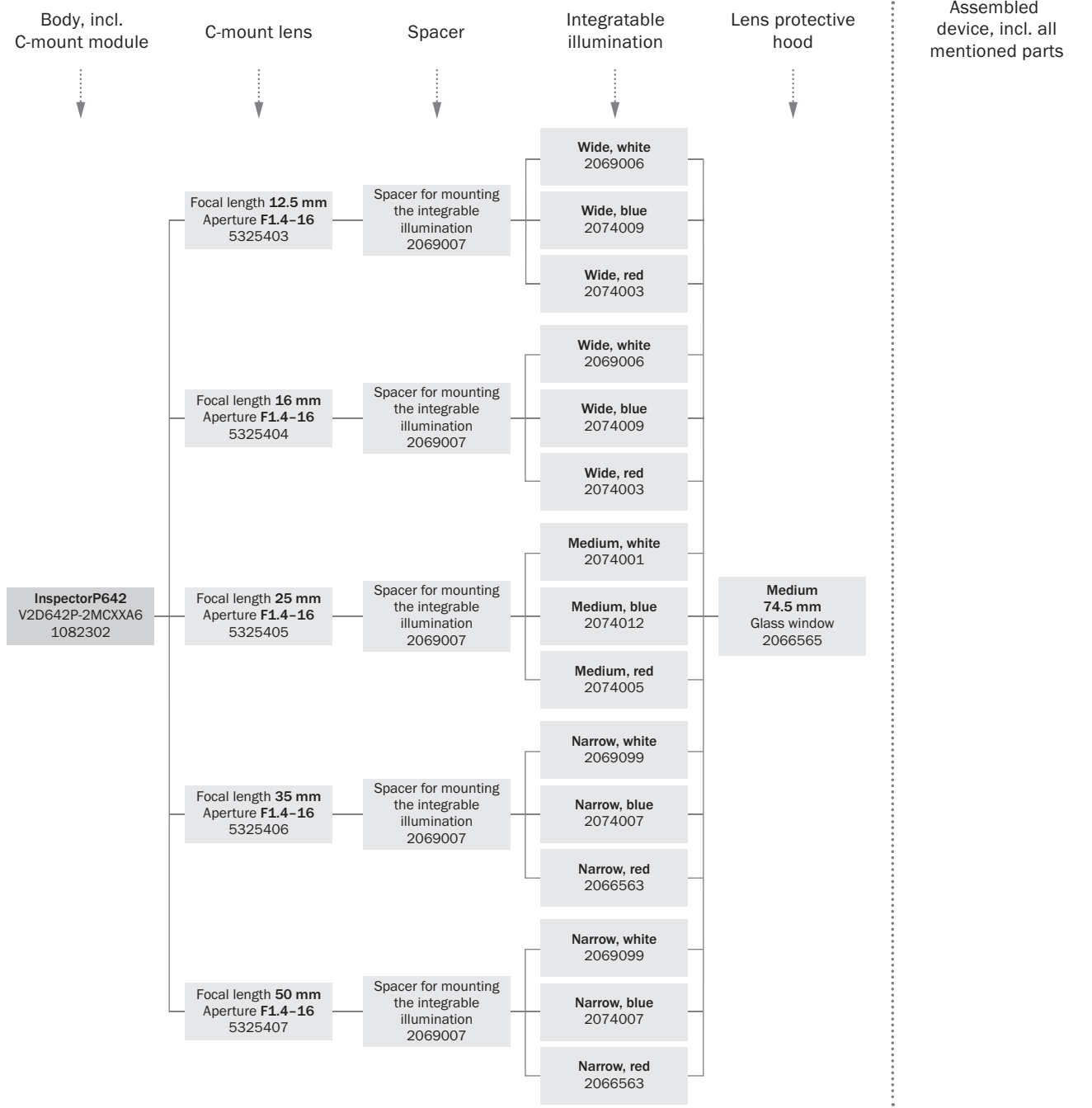
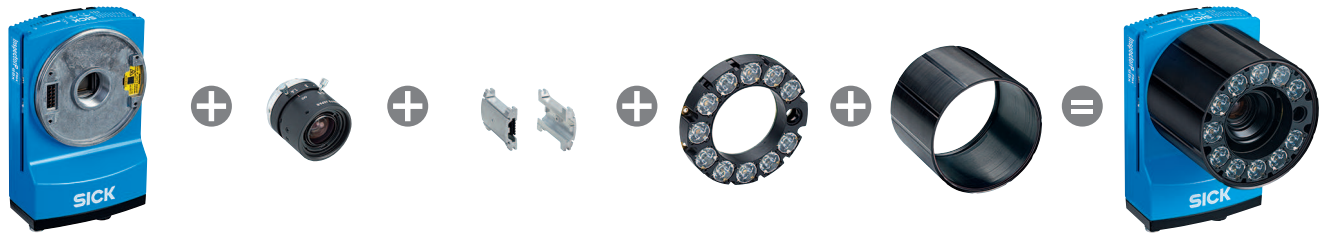



Overview

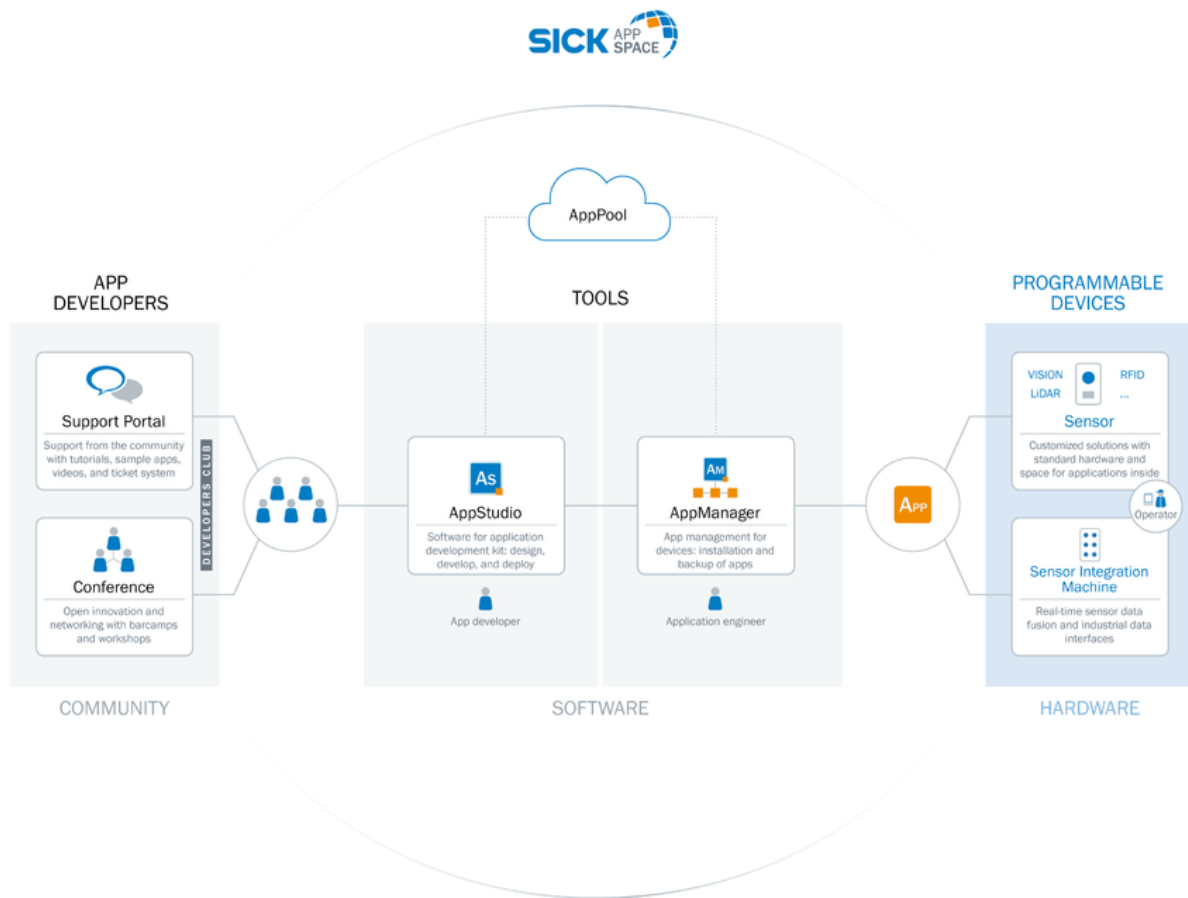

SICK AppSpace



Recommended accessories

Other models and accessories → www.sick.com/InspectorP64x

	Brief description	Type	Part no.
Lenses and accessories			
	C-mount 1/1.8", focal length 25 mm, aperture 1.4 – 16, 35 mm (Without C-mount thread)	C-mount lens	5325405
	Optics protection hood, enclosure rating IP 65, length: 74.5 mm, glass window	Protective cover for optics	2066565
	Spacer for mounting the integrable illumination, length: 51.3 mm	Spacer	2069007

	Brief description	Type	Part no.
Illuminations			
	Integratable lighting, lighting color white, medium, suitable for lenses with a focal length of 25 mm	VI83I-WH1441M0	2074001
Mounting brackets and plates			
	Mounting bracket kit comprising mounting bracket, cooling plate and screws, including angle indicator for adjusting the tilt angle	Mounting bracket kit	2069171
Other mounting accessories			
	Sliding nut, M5, short	Sliding nut	5324896
Others			
	<ul style="list-style-type: none"> • Connection type head A: Female connector, M12, 17-pin, straight, A-coded • Connection type head B: Male connector, M12, 17-pin, straight, A-coded • Signal type: Power, serial, CAN, digital I/Os • Cable: 3 m, 17-wire • Description: Power, serial, CAN, digital I/Os, suitable for 2 A, shielded, to connection module CDB650 • Application: Drag chain operation 	YM2A8D-030XXXF2A8D	6051194
	<ul style="list-style-type: none"> • Connection type head A: Male connector, M12, 8-pin, straight, X-coded • Connection type head B: Male connector, RJ45, 8-pin, straight • Signal type: Ethernet, Gigabit Ethernet • Cable: 2 m, 8-wire, PUR, halogen-free • Description: Ethernet, Gigabit Ethernet, shielded • Application: Zones with oils and lubricants 	YM2X18-020EG1MRJA8	2106258
	<ul style="list-style-type: none"> • Connection type head A: Male connector, M12, 8-pin, straight, X-coded • Connection type head B: Male connector, RJ45, 8-pin, straight • Signal type: Ethernet, Gigabit Ethernet • Cable: 3 m, 8-wire, PUR, halogen-free • Description: Ethernet, Gigabit Ethernet, shielded • Application: Zones with oils and lubricants 	YM2X18-030EG1MRJA8	2145693
Modules			
	<ul style="list-style-type: none"> • Accessory group: 4DproConnectivity • Product family: Connection Device Basic • Sub product family: CDB650 • Supported products: Lector series, CLV62x - CLV64x (depending on type), CLV69x, RFID read/write device, InspectorP series • Brief description: Connection device basic for connecting one sensor with 2 A fuse, 5 cable glands and RS-232 interface to sensor via M12, 17-pin female connector, all outputs available on screw/spring-loaded terminals. 	CDB650-204	1064114

Recommended services

Additional services → www.sick.com/InspectorP64x

	Type	Part no.
Extended warranty		
<ul style="list-style-type: none">• Product area: Machine vision, LiDAR sensors, safety camera sensors, Safety laser scanners, Safety radar sensors, Radar sensors, Fixed mount barcode scanners, Image-based code readers, RFID, Mobile handheld scanners• Range of services: The services correspond to the scope of the statutory manufacturer warranty (SICK general terms of delivery).• Duration: Five-year warranty from delivery date.	Extended warranty for a total of five years from delivery date	1680671

SICK AT A GLANCE

SICK is one of the leading manufacturers of intelligent sensors and sensor solutions for industrial applications. A unique range of products and services creates the perfect basis for controlling processes securely and efficiently, protecting individuals from accidents and preventing damage to the environment.

We have extensive experience in a wide range of industries and understand their processes and requirements. With intelligent sensors, we can deliver exactly what our customers need. In application centers in Europe, Asia and North America, system solutions are tested and optimized in accordance with customer specifications. All this makes us a reliable supplier and development partner.

Comprehensive services complete our offering: SICK LifeTime Services provide support throughout the machine life cycle and ensure safety and productivity.

For us, that is “Sensor Intelligence.”

WORLDWIDE PRESENCE:

Contacts and other locations –www.sick.com