



V3DU3-120RM25A

Ruler3000

3D MACHINE VISION

SICK
Sensor Intelligence.



Ordering information

Type	Part no.
V3DU3-120RM25A	1132220

Other models and accessories → www.sick.com/Ruler3000



Detailed technical data

Features

Technology	3D triangulation
Pre-calibrated	✓
Product category	Streaming, pre-calibrated
Shutter technology	Global-Shutter
Working distance	430 mm ... 1,445 mm
Example field of view	1,200 mm x 345 mm
Exposure mode	Linear HDR
Illumination	Integrated
Illumination color	Red, laser, Visible, 660 nm, ± 15 nm
Laser class	2 (EN 60825-1:2014+A11:2021; IEC 60825-1:2014, Complies with the FDA performance requirements for laser products except for conformance with IEC 60825-1 Ed.3., as described in Laser Notice 56 dated May 8, 2019.)
Data synchronization	Free running, encoder triggered, external triggering
Factory calibrated	✓
3D measurement	✓
Scatter measurement	✓
Reflectance measurement	✓
Ambient light suppression	✓ ¹⁾

¹⁾ Red bandpass filter.

Scheimpflug adapter, integrated	✓
Width at minimum operating distance	540 mm
Width at maximum operating distance	1,680 mm
Maximum height range	1,015 mm
Task	Detecting - Standard objects Detecting - Level Measuring - Dimension, contour and volume Monitoring and controlling - Quality Determining position - 3D position determination

¹⁾ Red bandpass filter.

Mechanics/electronics

Connection type	Voltage – I/O: M12, 17-pin male connector Gigabit Ethernet: M12, 8-pin socket, X-coded
Connector material	M12: Nickel-coated brass
Supply voltage	24 V DC, ± 10 %
Ripple	< 5 V _{pp}
Power consumption	≤ 12 W
Current consumption	≤ 1.5 A
Enclosure rating	IP65 IP67
Protection class	III
Housing material	Aluminum
Housing color	Blue
Window material	PMMA
Weight	2.3 kg
Dimensions (L x W x H)	336 mm x 77 mm x 138 mm

Performance

Image sensor	CMOS sensor from SICK with ROCC technology, M30
Scan/frame rate	46,000 3D profiles/s, In reduced ROI 7,000 3D profiles/s, full format
Data points/profile	3,200
Repeatability	6.6 μm, for Z ¹⁾
Typical resolution	Z resolution (height): 33 μm ... 265 μm, X resolution (width): 246 μm ... 710 μm

¹⁾ Height values measured for different positions in the field of view. 20 measurements are performed at each position. The repeatability value is the 3-fold of the standard deviation (3 σ) for all measurements at all positions.

Interfaces

Ethernet	✓, UDP/IP
Data transmission rate	≤ 1 Gbit/s
Configuration software	Stream Setup
Operating system	Windows 10
Programming interface	GenAPI, GenTL, Proprietary SICK GenIStream
Inputs/outputs	4 x HIGH = 10 V ... 28.8 V, configurable
Encoder interface	RS-422 5 V, 2 x HTL single-ended

Ambient data

Shock load	15 g, 3 cycles per axis
Vibration load	5 g, 10 Hz ... 150 Hz (EN 60068-2-6)
Ambient operating temperature	0 °C ... +50 °C ¹⁾
Storage temperature	-30 °C ... +70 °C ¹⁾
Depth precision	6.6 µm, for Z ²⁾

¹⁾ Non-condensing.

²⁾ Height values measured for different positions in the field of view. 20 measurements are performed at each position. The repeatability value is the 3-fold of the standard deviation (3 σ) for all measurements at all positions.

Classifications

ECLASS 5.0	27310205
ECLASS 5.1.4	27310205
ECLASS 6.0	27310205
ECLASS 6.2	27310205
ECLASS 7.0	27310205
ECLASS 8.0	27310205
ECLASS 8.1	27310205
ECLASS 9.0	27310205
ECLASS 10.0	27310205
ECLASS 11.0	27310205
ECLASS 12.0	27310205
ETIM 5.0	EC001820
ETIM 6.0	EC001820
ETIM 7.0	EC001820
ETIM 8.0	EC001820
UNSPSC 16.0901	43211731

Dimensional drawing (Dimensions in mm (inch))

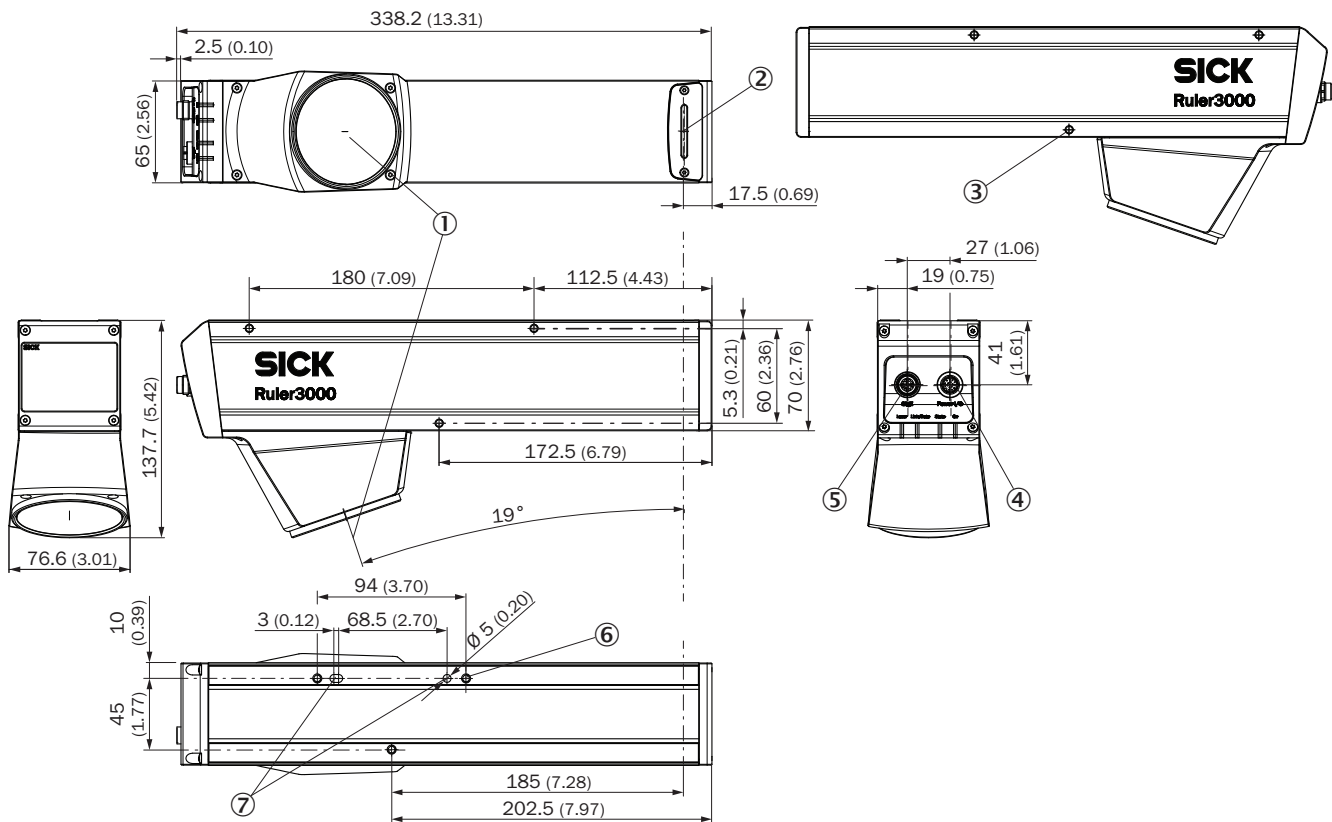

- ① Optical receiver (center)
- ② Optical sender (center)
- ③ Threaded mounting hole (M5, 12 mm deep) with through hole (\varnothing 4.2 mm)
- ④ Power I/O connection
- ⑤ Gigabit Ethernet connection (GbE)
- ⑥ Threaded mounting hole (M5, 9 mm deep)
- ⑦ Position and alignment hole for locating pins (\varnothing 5 mm)

Field of view

Ruler3120

Guaranteed field of view in mm

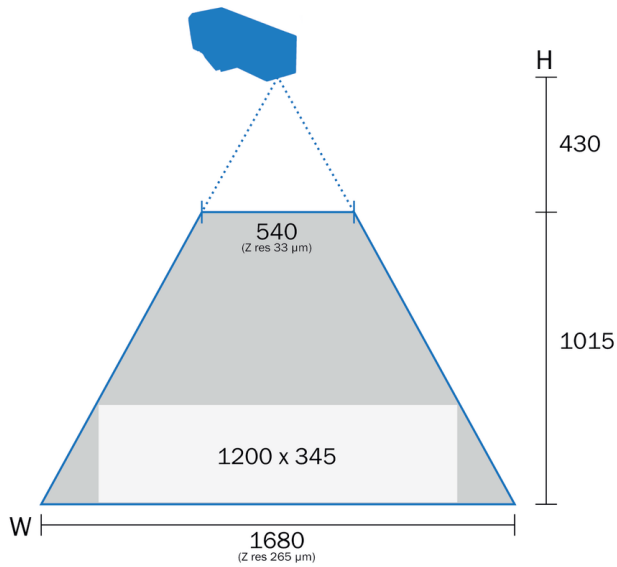

Characteristic curve

Width of the field of view via the Z position

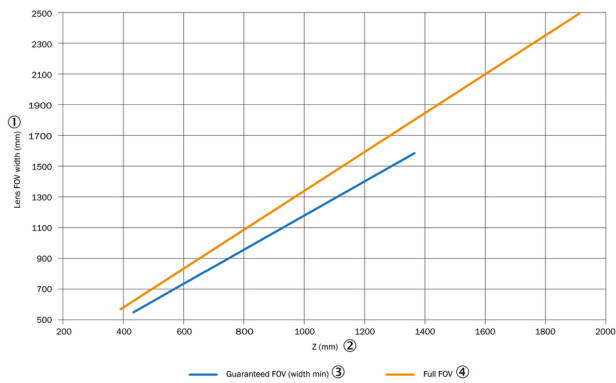

Z resolution via Z position

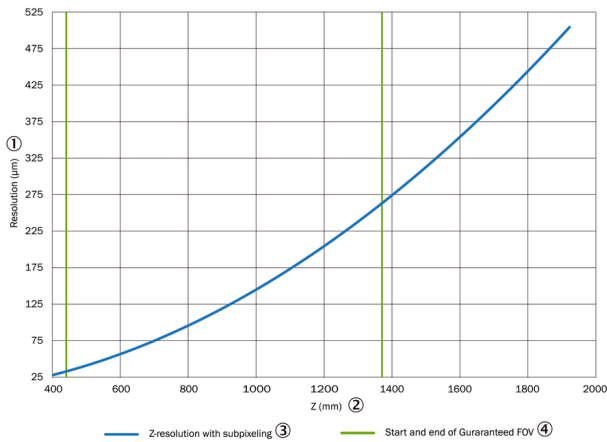

X resolution via Z position

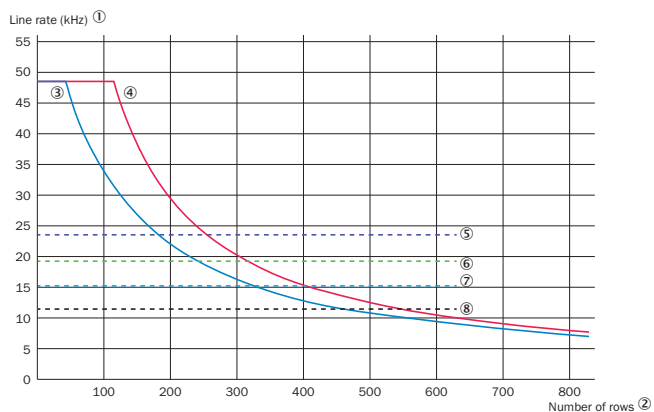
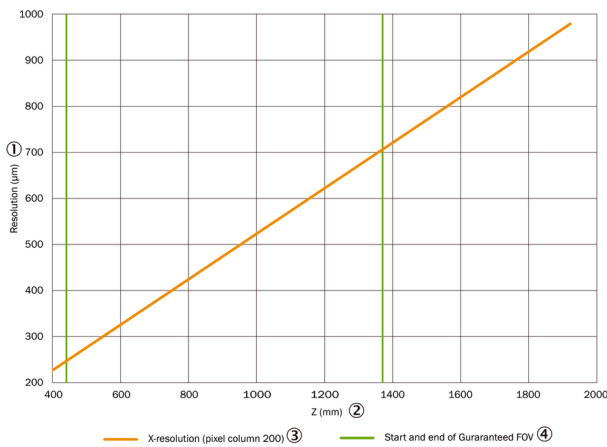





The maximum line rate is based on the number of sensor lines used

- ① Line rate (kHz)
- ② Number of lines
- ③ Ruler3000 with activated HDR
- ④ Ruler3000 without activated HDR
- ⑤ Bandwidth limit for image width 2,560, height range only
- ⑥ Bandwidth limit for image width 3,072, height range only
- ⑦ Bandwidth limit for image width 2,560, height range and reflectance
- ⑧ Bandwidth limit for image width 3,072, height range and reflectance

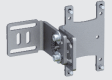
Recommended accessories

Other models and accessories → www.sick.com/Ruler3000

	Brief description	Type	Part no.
Mounting brackets and plates			
	Mounting bracket set consisting of mounting bracket, cooling plate, includes angle display for setting the tilt angle	Mounting bracket	2076735
Others			
	<ul style="list-style-type: none"> • Connection type head A: Female connector, M12, 17-pin, straight, A-coded • Connection type head B: Flying leads • Signal type: Sensor/actuator cable • Cable: 3 m, 17-wire, PUR • Description: Sensor/actuator cable, twisted pair, shielded • Application: Drag chain operation 	YF2A2D-030UV1XLEAX	6042772
	<ul style="list-style-type: none"> • Connection type head A: Male connector, M12, 8-pin, straight, X-coded • Connection type head B: Male connector, RJ45, 8-pin, straight • Signal type: Ethernet, Gigabit Ethernet • Cable: 2 m, 8-wire, PUR, halogen-free • Description: Ethernet, Gigabit Ethernet, shielded • Application: Zones with oils and lubricants 	YM2X18-020EG1MRJA8	2106258
	<ul style="list-style-type: none"> • Connection type head A: Male connector, M12, 8-pin, straight, X-coded • Connection type head B: Male connector, RJ45, 8-pin, straight • Signal type: Ethernet, Gigabit Ethernet • Cable: 3 m, 8-wire, PUR, halogen-free • Description: Ethernet, Gigabit Ethernet, shielded • Application: Zones with oils and lubricants 	YM2X18-030EG1MRJA8	2145693

Recommended services

Additional services → www.sick.com/Ruler3000

	Type	Part no.
Extended warranty		
<ul style="list-style-type: none"> • Product area: Machine vision, LiDAR sensors, safety camera sensors, Safety laser scanners, Safety radar sensors, Radar sensors, Fixed mount barcode scanners, Image-based code readers, RFID, Mobile handheld scanners • Range of services: The services correspond to the scope of the statutory manufacturer warranty (SICK general terms of delivery). • Duration: Five-year warranty from delivery date. 	Extended warranty for a total of five years from delivery date	1680671

SICK AT A GLANCE

SICK is one of the leading manufacturers of intelligent sensors and sensor solutions for industrial applications. A unique range of products and services creates the perfect basis for controlling processes securely and efficiently, protecting individuals from accidents and preventing damage to the environment.

We have extensive experience in a wide range of industries and understand their processes and requirements. With intelligent sensors, we can deliver exactly what our customers need. In application centers in Europe, Asia and North America, system solutions are tested and optimized in accordance with customer specifications. All this makes us a reliable supplier and development partner.

Comprehensive services complete our offering: SICK LifeTime Services provide support throughout the machine life cycle and ensure safety and productivity.

For us, that is “Sensor Intelligence.”

WORLDWIDE PRESENCE:

Contacts and other locations –www.sick.com