



# VFS60E-TBNJ01024

VFS60

MOTOR FEEDBACK SYSTEMS ROTARY INCREMENTAL

**SICK**  
Sensor Intelligence.



Illustration may differ



### Ordering information

Type	Part no.
VFS60E-TBNJ01024	1053483

Other models and accessories → [www.sick.com/VFS60](http://www.sick.com/VFS60)

### Detailed technical data

#### Performance

<b>Number of lines per revolution</b>	1,024
<b>Reference signal, number</b>	1
<b>Reference signal, position</b>	90° electronically, gated with Sinus and Cosinus
<b>Measuring step deviation</b>	± 0.2°

#### Interfaces

<b>Communication interface</b>	Incremental
--------------------------------	-------------

#### Electrical data

<b>Connection type</b>	Cable, 8-wire, radial, 0.5 m <sup>1)</sup>
<b>Supply voltage</b>	4.5 V ... 5.5 V
<b>Current consumption</b>	40 mA <sup>2)</sup>
<b>Maximum output frequency</b>	≤ 200 kHz
<b>Load resistance</b>	≥ 120 Ω

<sup>1)</sup> The universal cable connection is positioned so that it is possible to lay it without bends in a radial or axial direction.

<sup>2)</sup> Without load.

#### Mechanical data

<b>Shaft version</b>	Through hollow shaft
<b>Shaft diameter</b>	8 mm
<b>Shaft material</b>	Metal
<b>Flange type / stator coupling</b>	Standard
<b>Dimensions</b>	See dimensional drawing
<b>Weight</b>	+ 0.2 kg
<b>Moment of inertia of the rotor</b>	40 gcm <sup>2</sup>
<b>Operating speed</b>	9,000 min <sup>-1</sup> <sup>1)</sup>
<b>Angular acceleration</b>	≤ 500,000 rad/s <sup>2</sup>

<sup>1)</sup> Allow for self-heating of 3.3 K per 1,000 rpm when designing the operating temperature range.

<b>Operating torque</b>	0.6 Ncm (+20 °C)
<b>Start up torque</b>	+ 0.8 Ncm (+20 °C)
<b>Permissible movement of the drive element, static</b>	± 0.3 mm radial ± 0.5 mm axial
<b>Permissible movement of the drive element, dynamic</b>	± 0.1 mm radial ± 0.2 mm axial
<b>Life of ball bearings</b>	3.0 x 10 <sup>9</sup> revolutions

<sup>1)</sup> Allow for self-heating of 3.3 K per 1,000 rpm when designing the operating temperature range.

## Ambient data

<b>Operating temperature range</b>	-30 °C ... +100 °C
<b>Storage temperature range</b>	-40 °C ... +100 °C, without package
<b>Relative humidity/condensation</b>	90 %, Condensation not permitted
<b>Resistance to shocks</b>	70 g, 6 ms (according to EN 60068-2-27)
<b>Frequency range of resistance to vibrations</b>	30 g, 10 Hz ... 2,000 Hz (EN 60068-2-6)
<b>EMC</b>	According to EN 61000-6-2 and EN 61000-6-3
<b>Enclosure rating</b>	IP65, shaft side (IEC 60529) IP65, housing side, cable connection (IEC 60529)

## Classifications

<b>eCl@ss 5.0</b>	27270501
<b>eCl@ss 5.1.4</b>	27270501
<b>eCl@ss 6.0</b>	27270590
<b>eCl@ss 6.2</b>	27270590
<b>eCl@ss 7.0</b>	27270501
<b>eCl@ss 8.0</b>	27270501
<b>eCl@ss 8.1</b>	27270501
<b>eCl@ss 9.0</b>	27270501
<b>eCl@ss 10.0</b>	27273805
<b>eCl@ss 11.0</b>	27273901
<b>eCl@ss 12.0</b>	27273901
<b>ETIM 5.0</b>	EC001486
<b>ETIM 6.0</b>	EC001486
<b>ETIM 7.0</b>	EC001486
<b>ETIM 8.0</b>	EC001486
<b>UNSPSC 16.0901</b>	41112113

### Dimensional drawing (Dimensions in mm (inch))

Through hollow shaft, cable

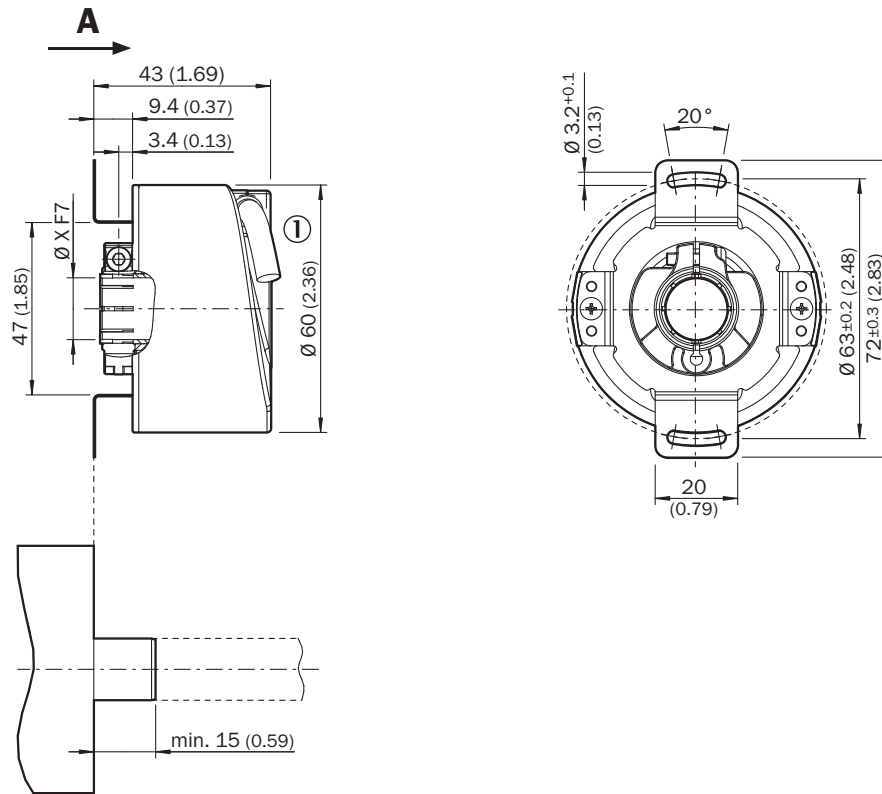

General tolerances according to DIN ISO 2768-mk



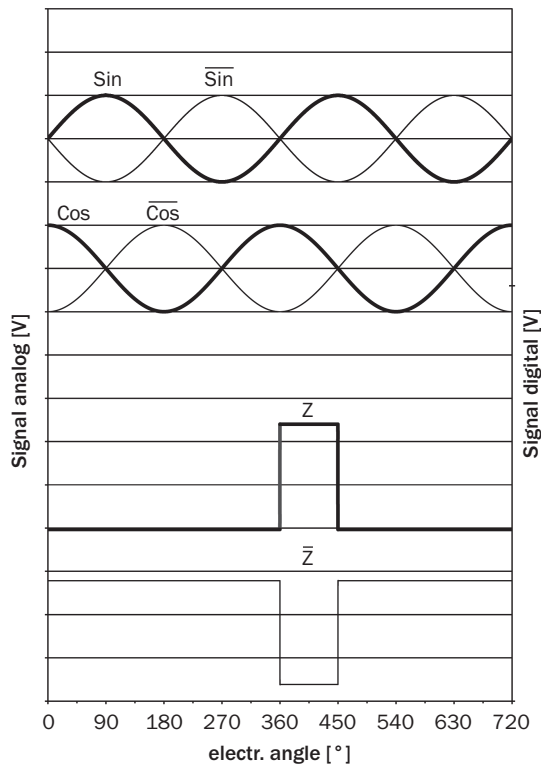

① Cable diameter = 5.6 mm +/- 0.2 mm bend radius = 30 mm

## Diagrams

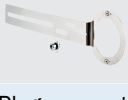

## Recommended accessories

Other models and accessories → [www.sick.com/VFS60](http://www.sick.com/VFS60)

	Brief description	Type	Part no.
<b>Programming and configuration tools</b>			
	SVip@ LAN programming tool for all motor feedback systems	PGT-11-S LAN	1057324
<b>Flanges</b>			
	One-sided stator coupling, slot, slot radius 33 mm to 48.5 mm, slot width 5.1 mm	BEF-DS01DFS/VFS	2047428
	One-sided stator coupling, slot, slot radius 32.25 mm to 141.75 mm, slot width 5.1 mm	BEF-DS02DFS/VFS	2047430
	One-sided stator coupling, slot, slot radius 33 mm to 211.9 mm, slot width 5.1 mm	BEF-DS03DFS/VFS	2047431
<b>Plug connectors and cables</b>			
	Head A: cable Head B: Flying leads Cable: SSI, Incremental, HIPERFACE®, PUR, halogen-free, shielded	LTG-2308-MWENC	6027529

	Brief description	Type	Part no.
	Head A: cable Head B: Flying leads Cable: SSI, Incremental, PUR, shielded	LTG-2411-MW	6027530
	Head A: cable Head B: Flying leads Cable: SSI, Incremental, PUR, halogen-free, shielded	LTG-2512-MW	6027531
	Head A: cable Head B: Flying leads Cable: SSI, TTL, HTL, Incremental, PUR, halogen-free, shielded	LTG-2612-MW	6028516
	Head A: female connector, JST, 8-pin, straight Head B: Flying leads Cable: Incremental, PUR, halogen-free, shielded, 3 m	DOL-0J08-G03MAA3	2046875
	Head A: female connector, JST, 8-pin, straight Head B: Flying leads Cable: Incremental, SSI, PUR, halogen-free, shielded, 5 m	DOL-0J08-G05MAA3	2046876
	Head A: female connector, JST, 8-pin, straight Head B: Flying leads Cable: Incremental, SSI, PUR, halogen-free, shielded, 0.5 m	DOL-0J08-G0M5AA3	2046873
	Head A: female connector, JST, 8-pin, straight Head B: Flying leads Cable: Incremental, SSI, PUR, halogen-free, shielded, 10 m	DOL-0J08-G10MAA3	2046877
	Head A: female connector, JST, 8-pin, straight Head B: Flying leads Cable: Incremental, PUR, halogen-free, shielded, 1.5 m	DOL-0J08-G1M5AA3	2046874
	Head A: female connector, M23, 12-pin, straight Head B: Flying leads Cable: Incremental, PUR, shielded, 2 m	DOL-2312-G02MLA3	2030682
	Head A: female connector, M23, 12-pin, straight Head B: Flying leads Cable: Incremental, PUR, halogen-free, shielded, 3 m	DOL-2312-G03MMA3	2029213
	Head A: female connector, M23, 12-pin, straight Head B: Flying leads Cable: Incremental, PUR, halogen-free, shielded, 5 m	DOL-2312-G05MMA3	2029214
	Head A: female connector, M23, 12-pin, straight Head B: Flying leads Cable: Incremental, PUR, shielded, 7 m	DOL-2312-G07MLA3	2030685
	Head A: female connector, M23, 12-pin, straight Head B: Flying leads Cable: Incremental, PUR, shielded, 10 m	DOL-2312-G10MLA3	2030688
	Head A: female connector, M23, 12-pin, straight Head B: Flying leads Cable: Incremental, PUR, halogen-free, shielded, 10 m	DOL-2312-G10MMA3	2029215
	Head A: female connector, M23, 12-pin, straight Head B: Flying leads Cable: Incremental, PUR, shielded, 15 m	DOL-2312-G15MLA3	2030692
	Head A: female connector, M23, 12-pin, straight Head B: Flying leads Cable: Incremental, PUR, halogen-free, shielded, 1.5 m	DOL-2312-G1M5MA3	2029212
	Head A: female connector, M23, 12-pin, straight Head B: Flying leads Cable: Incremental, PUR, shielded, 20 m	DOL-2312-G20MLA3	2030695
	Head A: female connector, M23, 12-pin, straight Head B: Flying leads Cable: Incremental, PUR, halogen-free, shielded, 20 m	DOL-2312-G20MMA3	2029216

	Brief description	Type	Part no.
	Head A: female connector, M23, 12-pin, straight Head B: Flying leads Cable: Incremental, PUR, shielded, 25 m	DOL-2312-G25MLA3	2030699
	Head A: female connector, M23, 12-pin, straight Head B: Flying leads Cable: Incremental, PUR, shielded, 30 m	DOL-2312-G30MLA3	2030702
	Head A: female connector, M23, 12-pin, straight Head B: Flying leads Cable: Incremental, PUR, halogen-free, shielded, 30 m	DOL-2312-G30MMA3	2029217
	Head A: male connector, M12, 2-pin, angled, B-coded Head B: Flying leads Cable: Fieldbus, PROFIBUS DP, PUR, halogen-free, shielded, 5 m	YN2B22-050PB1XLEAX	2106277
	Head A: male connector, M12, 2-pin, angled, B-coded Head B: Flying leads Cable: Fieldbus, PROFIBUS DP, PUR, halogen-free, shielded, 10 m	YN2B22-100PB1XLEAX	2106278
	Head A: female connector, JST, 8-pin, straight Head B: male connector, M23, 17-pin, straight Cable: Incremental, unshielded, 1 m	DSL-2317-G01MJB7	2071332
	Head A: female connector, terminal box, 8-pin, straight Head B: male connector, M23, 17-pin, straight Cable: Incremental, unshielded, 1 m	DSL-2317-G01MJC7	2071331
	Head A: female connector, JST, 8-pin, straight Head B: male connector, M23, 12-pin, straight Cable: Incremental, PUR, halogen-free, shielded, 1 m	STL-2312-G01MAA3	2061622
	Head A: female connector, JST, 8-pin, straight Head B: male connector, M23, 12-pin, straight Cable: Incremental, PUR, halogen-free, shielded, 2 m	STL-2312-G02MAA3	2061504
	Head A: female connector, JST, 8-pin, straight Head B: male connector, M23, 12-pin, straight Cable: Incremental, PUR, halogen-free, shielded, 0.35 m	STL-2312-GM35AA3	2061621
	Head A: female connector, M23, 9-pin, straight Cable: HIPERFACE <sup>®</sup> , SSI, Incremental, shielded	DOS-2309-G	6028533
	Head A: female connector, M23, 12-pin, straight Cable: HIPERFACE <sup>®</sup> , SSI, Incremental, shielded	DOS-2312-G	6027538
	Head A: female connector, M23, 12-pin, angled Cable: HIPERFACE <sup>®</sup> , SSI, Incremental, shielded	DOS-2312-W01	2072580
	Head A: male connector, M23, 12-pin, straight Cable: HIPERFACE <sup>®</sup> , SSI, Incremental, RS-422, shielded	STE-2312-G	6027537

## SICK AT A GLANCE

SICK is one of the leading manufacturers of intelligent sensors and sensor solutions for industrial applications. A unique range of products and services creates the perfect basis for controlling processes securely and efficiently, protecting individuals from accidents and preventing damage to the environment.

We have extensive experience in a wide range of industries and understand their processes and requirements. With intelligent sensors, we can deliver exactly what our customers need. In application centers in Europe, Asia and North America, system solutions are tested and optimized in accordance with customer specifications. All this makes us a reliable supplier and development partner.

Comprehensive services complete our offering: SICK LifeTime Services provide support throughout the machine life cycle and ensure safety and productivity.

For us, that is “Sensor Intelligence.”

## WORLDWIDE PRESENCE:

Contacts and other locations –[www.sick.com](http://www.sick.com)