



VL18L-4P344

V18 Laser

CYLINDRICAL PHOTOELECTRIC SENSORS

SICK
Sensor Intelligence.



Ordering information

Type	Part no.
VL18L-4P344	6027434

Other models and accessories → www.sick.com/V18_Laser

Illustration may differ



Detailed technical data

Features

Functional principle	Photoelectric retro-reflective sensor
Functional principle detail	With minimum distance to reflector (dual lens system)
Dimensions (W x H x D)	18 mm x 18 mm x 107.7 mm
Housing design (light emission)	Cylindrical
Housing length	107.7 mm
Thread diameter (housing)	M18 x 1
Optical axis	Radial
Sensing range max.	0.1 m ... 35 m ¹⁾
Sensing range	0.1 m ... 30 m ¹⁾
Focus	0.04°
Type of light	Visible red light
Light source	Laser ²⁾
Light spot size (distance)	Ø 9 mm (35 m)
Angle of dispersion	0.04°
Wave length	650 nm
Laser class	1 (IEC 60825-1)
Laser power output	0.4 mW
Adjustment	Cable, Single teach-in button (Sensitivity, Sensitivity) ^{3) 4)}
Special applications	Detecting small objects

¹⁾ Reflector P250F.

²⁾ Average service life: 100,000 h at T_J = +25 °C.

³⁾ Electronically via control input C (0 V).

⁴⁾ Manual, via teach-in button.

Mechanics/electronics

Supply voltage U_B	10 V DC ... 30 V DC ¹⁾
Ripple	$\pm 10\%$ ²⁾
Current consumption	20 mA ³⁾
Switching output	PNP
Switching mode	Light/dark switching
Switching mode selector	Selectable via control input C
Output current I_{max}	≤ 100 mA
Response time	≤ 0.625 ms ⁴⁾
Switching frequency	800 Hz ⁵⁾
Connection type	Male connector M12, 4-pin
Circuit protection	A ⁶⁾ B ⁷⁾ C ⁸⁾ D ⁹⁾
Protection class	III
Weight	60 g
Polarisation filter	✓
Housing material	Metal, Nickel-plated brass/PC
Optics material	Plastic, PC with protective glass pane
Enclosure rating	IP67
Ambient operating temperature	-15 °C ... +55 °C
Ambient temperature, storage	-25 °C ... +70 °C
UL File No.	NRKH.E181493, CDRH-conform (0312012-00)

¹⁾ Limit values.

²⁾ May not exceed or fall below U_V tolerances.

³⁾ Without load.

⁴⁾ Signal transit time with resistive load.

⁵⁾ With light/dark ratio 1:1.

⁶⁾ A = V_S connections reverse-polarity protected.

⁷⁾ B = inputs and output reverse-polarity protected.

⁸⁾ C = interference suppression.

⁹⁾ D = outputs overcurrent and short-circuit protected.

Safety-related parameters

MTTF_D	480 years
DC_{avg}	0 %

Classifications

ECLASS 5.0	27270902
ECLASS 5.1.4	27270902
ECLASS 6.0	27270902
ECLASS 6.2	27270902
ECLASS 7.0	27270902
ECLASS 8.0	27270902

ECLASS 8.1	27270902
ECLASS 9.0	27270902
ECLASS 10.0	27270902
ECLASS 11.0	27270902
ECLASS 12.0	27270902
ETIM 5.0	EC002717
ETIM 6.0	EC002717
ETIM 7.0	EC002717
ETIM 8.0	EC002717
UNSPSC 16.0901	39121528

Connection type

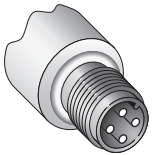

Connection diagram

Cd-099

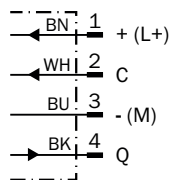

Characteristic curve

Operating reserve

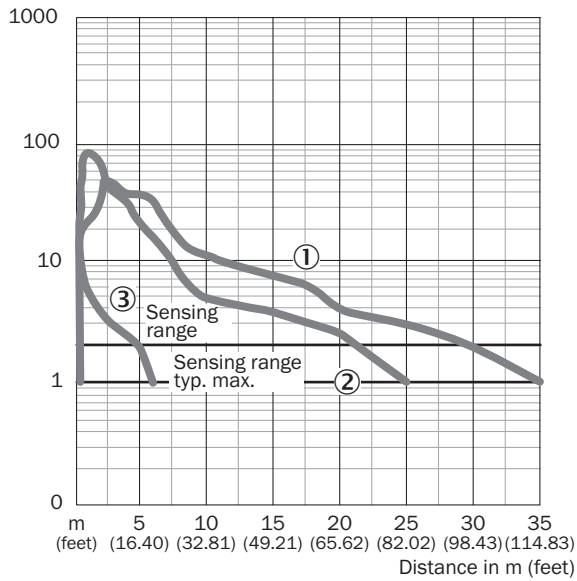

- ① Reflector P250F
- ② Reflector PL80A, P250
- ③ Reflective tape Diamond Grade

Light spot size

VL18L

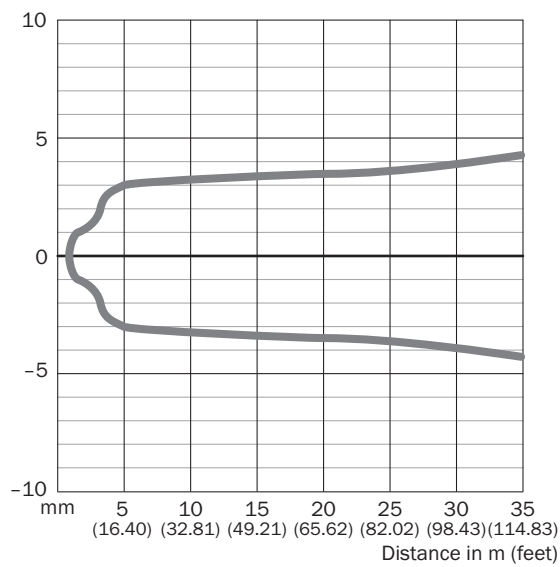

Sensing range diagram

VL18L

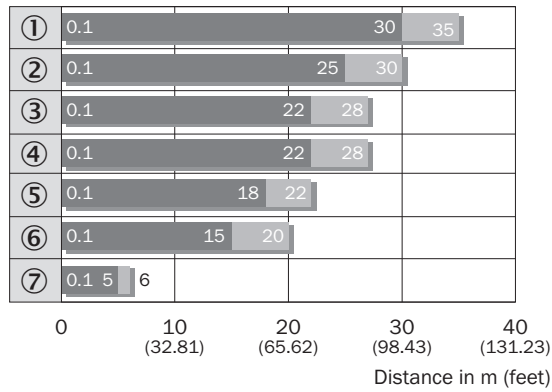

■ Sensing range ■ Sensing range max.

- ① Reflector P250F
- ② PL10F reflector
- ③ Reflector PL80A
- ④ Reflector P250
- ⑤ Reflector C110A
- ⑥ Reflector PL20F
- ⑦ Reflective tape Diamond Grade

Dimensional drawing (Dimensions in mm (inch))

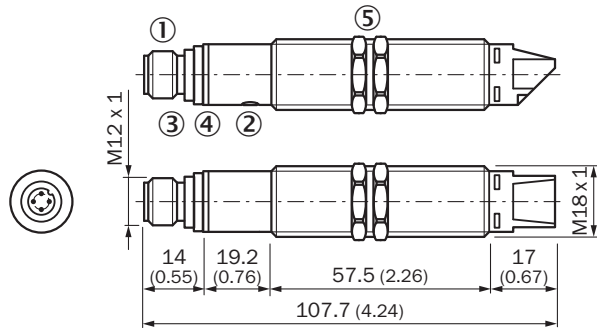

Radial



- ① M12 male device connector, 4-pin
- ② Sensitivity setting: single teach-in button
- ③ Green LED indicator: V_S Supply voltage feed
- ④ Yellow LED indicator: - lights continuously: Reception signal > reserve factor 2 - blinks: Reception signal < reserve factor 2 but > switching threshold 1
- ⑤ Fastening nuts (2 x); width across 24, metal(included with delivery)

Recommended accessories

Other models and accessories → www.sick.com/V18_Laser

	Brief description	Type	Part no.
Reflectors			
	Fine triple reflector, screw connection, suitable for laser sensors, 52 mm x 62 mm, PM-MA/ABS, Screw-on, 2 hole mounting	P250F	5308843
Others			
	<ul style="list-style-type: none"> • Connection type head A: Female connector, M12, 4-pin, straight, A-coded • Connection type head B: Flying leads • Signal type: Sensor/actuator cable • Cable: 5 m, 4-wire, PVC • Description: Sensor/actuator cable, unshielded • Application: Zones with chemicals 	YF2A14-050VB3XLEAX	2096235
	<ul style="list-style-type: none"> • Connection type head A: Male connector, M12, 4-pin, straight, A-coded • Description: Unshielded • Connection systems: Screw-type terminals • Permitted cross-section: ≤ 0.75 mm² 	STE-1204-G	6009932

SICK AT A GLANCE

SICK is one of the leading manufacturers of intelligent sensors and sensor solutions for industrial applications. A unique range of products and services creates the perfect basis for controlling processes securely and efficiently, protecting individuals from accidents and preventing damage to the environment.

We have extensive experience in a wide range of industries and understand their processes and requirements. With intelligent sensors, we can deliver exactly what our customers need. In application centers in Europe, Asia and North America, system solutions are tested and optimized in accordance with customer specifications. All this makes us a reliable supplier and development partner.

Comprehensive services complete our offering: SICK LifeTime Services provide support throughout the machine life cycle and ensure safety and productivity.

For us, that is “Sensor Intelligence.”

WORLDWIDE PRESENCE:

Contacts and other locations –www.sick.com