



VL18-4P3812

V18

CYLINDRICAL PHOTOELECTRIC SENSORS

SICK
Sensor Intelligence.



Ordering information

Type	Part no.
VL18-4P3812	6013639

Other models and accessories → www.sick.com/V18

Illustration may differ



Detailed technical data

Features

Functional principle	Photoelectric retro-reflective sensor
Dimensions (W x H x D)	18 mm x 18 mm x 60.6 mm
Housing design (light emission)	Cylindrical
Housing length	60.6 mm
Thread diameter (housing)	M18 x 1
Optical axis	Radial
Sensing range max.	0.05 m ... 3.7 m ¹⁾
Sensing range	0.05 m ... 3 m ¹⁾
Focus	Approx. 2.8°
Type of light	Visible red light
Light source	LED ²⁾
Light spot size (distance)	Ø 150 mm (3 m)
Angle of dispersion	Approx. 2.8°
Adjustment	None

¹⁾ Reflector C110A.

²⁾ Average service life: 100,000 h at T_J = +25 °C.

Mechanics/electronics

Supply voltage U_B	10 V DC ... 30 V DC ¹⁾
Ripple	± 10 % ²⁾

¹⁾ Limit values.

²⁾ May not fall below or exceed U_V tolerances.

³⁾ Without load.

⁴⁾ Control wire open: dark switching D.ON.

⁵⁾ Signal transit time with resistive load.

⁶⁾ With light/dark ratio 1:1.

⁷⁾ Do not bend below 0 °C.

⁸⁾ A = V_S connections reverse-polarity protected.

⁹⁾ B = inputs and output reverse-polarity protected.

¹⁰⁾ C = interference suppression.

¹¹⁾ D = outputs overcurrent and short-circuit protected.

Current consumption	30 mA ³⁾
Switching output	PNP ⁴⁾
Switching mode	Light/dark switching ⁴⁾
Switching mode selector	Selectable via L/D control cable
Output current I_{max}	≤ 100 mA
Response time	≤ 2 ms ⁵⁾
Switching frequency	250 Hz ⁶⁾
Connection type	Cable, 4-wire, 2 m ⁷⁾
Cable material	Plastic, PVC
Conductor cross section	0.14 mm ²
Cable diameter	Ø 5 mm
Circuit protection	A ⁸⁾ B ⁹⁾ C ¹⁰⁾ D ¹¹⁾
Protection class	III
Weight	100 g
Polarisation filter	✓
Housing material	Plastic, PBT/PC
Optics material	Plastic, PMMA
Enclosure rating	IP67
Ambient operating temperature	-25 °C ... +70 °C
UL File No.	NMFT2.E175606

1) Limit values.

2) May not fall below or exceed U_y tolerances.

3) Without load.

4) Control wire open: dark switching D.ON.

5) Signal transit time with resistive load.

6) With light/dark ratio 1:1.

7) Do not bend below 0 °C.

8) A = V_S connections reverse-polarity protected.

9) B = inputs and output reverse-polarity protected.

10) C = interference suppression.

11) D = outputs overcurrent and short-circuit protected.

Classifications

ECLASS 5.0	27270902
ECLASS 5.1.4	27270902
ECLASS 6.0	27270902
ECLASS 6.2	27270902
ECLASS 7.0	27270902
ECLASS 8.0	27270902
ECLASS 8.1	27270902
ECLASS 9.0	27270902

ECLASS 10.0	27270902
ECLASS 11.0	27270902
ECLASS 12.0	27270902
ETIM 5.0	EC002717
ETIM 6.0	EC002717
ETIM 7.0	EC002717
ETIM 8.0	EC002717
UNSPSC 16.0901	39121528

Adjustments

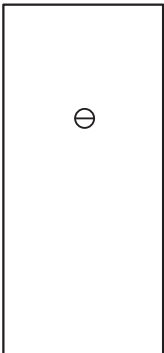

Connection type



Connection diagram

Cd-089

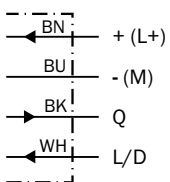

Characteristic curve

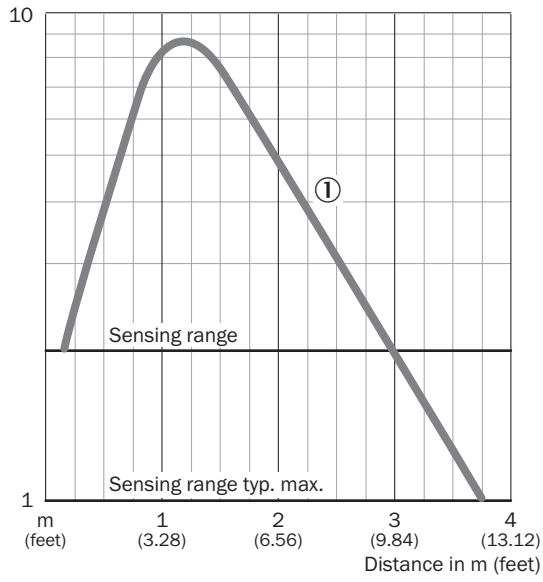

Sensing range diagram

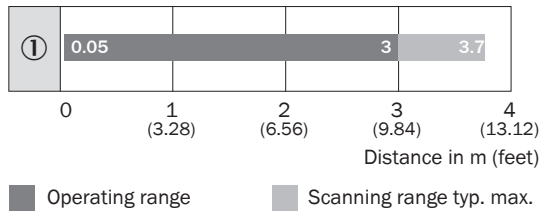



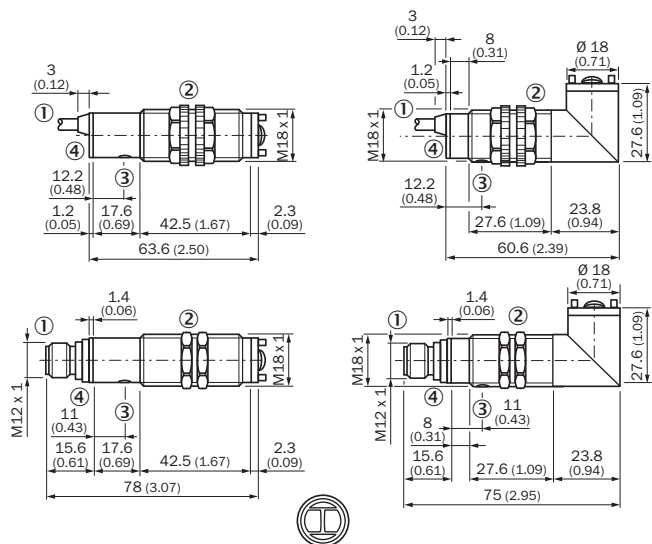

① Reflector type C110

Dimensional drawing (Dimensions in mm (inch))



Recommended accessories

Other models and accessories → www.sick.com/V18

	Brief description	Type	Part no.
Mounting brackets and plates			
	Mounting bracket for M18 sensors, steel, zinc coated, without mounting hardware	BEF-WN-M18	5308446
	Universal mounting bracket for reflectors, steel, zinc coated	BEF-WN-REFX	2064574
Reflectors			
	Rectangular, screw connection, 51 mm x 61 mm, PMMA/ABS, Screw-on, 2 hole mounting	P250	5304812
Others			
	<ul style="list-style-type: none"> • Connection type head A: Male connector, M12, 4-pin, straight, A-coded • Description: Unshielded • Connection systems: Screw-type terminals • Permitted cross-section: ≤ 0.75 mm² 	STE-1204-G	6009932

SICK AT A GLANCE

SICK is one of the leading manufacturers of intelligent sensors and sensor solutions for industrial applications. A unique range of products and services creates the perfect basis for controlling processes securely and efficiently, protecting individuals from accidents and preventing damage to the environment.

We have extensive experience in a wide range of industries and understand their processes and requirements. With intelligent sensors, we can deliver exactly what our customers need. In application centers in Europe, Asia and North America, system solutions are tested and optimized in accordance with customer specifications. All this makes us a reliable supplier and development partner.

Comprehensive services complete our offering: SICK LifeTime Services provide support throughout the machine life cycle and ensure safety and productivity.

For us, that is “Sensor Intelligence.”

WORLDWIDE PRESENCE:

Contacts and other locations –www.sick.com