



VSE180-2N42434

V180-2

CYLINDRICAL PHOTOELECTRIC SENSORS

SICK
Sensor Intelligence.



Illustration may differ

Ordering information

Type	Part no.
VSE180-2N42434	6043848

Other models and accessories → www.sick.com/V180-2



Detailed technical data

Features

Functional principle	Through-beam photoelectric sensor
Dimensions (W x H x D)	18 mm x 18 mm x 83.8 mm
Housing design (light emission)	Cylindrical
Housing length	83.8 mm
Optical axis	Radial
Sensing range max.	0 m ... 25 m
Sensing range	0 m ... 19 m
Focus	Approx. 5°
Type of light	Visible red light
Light source	LED ¹⁾
Light spot size (distance)	Ø 1,100 mm (20 m)
Angle of dispersion	Approx. 5°
Wave length	645 nm
Adjustment	Potentiometer, 270° (Sensitivity) ²⁾

¹⁾ Average service life: 100,000 h at T_U = +25 °C.

²⁾ Receiver.

Mechanics/electronics

Supply voltage U_B	10 V DC ... 30 V DC ¹⁾
Ripple	± 10 % ²⁾
Power consumption, sender	≤ 20 mA ³⁾
Power consumption, receiver	≤ 15 mA ³⁾
Switching output	NPN ⁴⁾

¹⁾ Limit values when operated in short-circuit protected network: max. 8 A.

²⁾ May not fall below or exceed U_V tolerances.

³⁾ Without load.

⁴⁾ Control wire open: light switching L.ON.

⁵⁾ Signal transit time with resistive load.

⁶⁾ With light/dark ratio 1:1.

⁷⁾ A = V_S connections reverse-polarity protected.

⁸⁾ B = inputs and output reverse-polarity protected.

⁹⁾ D = outputs overcurrent and short-circuit protected.

Switching mode	Light/dark switching ⁴⁾
Signal voltage NPN HIGH/LOW	Approx. $V_S / < 1.8 \text{ V}$
Output current I_{max}	$\leq 100 \text{ mA}$
Response time	$\leq 0.5 \text{ ms}$ ⁵⁾
Switching frequency	1,000 Hz ⁶⁾
Connection type	Male connector M12, 4-pin
Circuit protection	A ⁷⁾ B ⁸⁾ D ⁹⁾
Protection class	III
Weight	94 g
Housing material	Metal, Nickel-plated brass and PC
Optics material	Plastic, PMMA
Enclosure rating	IP67
Ambient operating temperature	-25 °C ... +55 °C
Ambient temperature, storage	-40 °C ... +70 °C

1) Limit values when operated in short-circuit protected network: max. 8 A.

2) May not fall below or exceed U_y tolerances.

3) Without load.

4) Control wire open: light switching L.ON.

5) Signal transit time with resistive load.

6) With light/dark ratio 1:1.

7) A = V_S connections reverse-polarity protected.

8) B = inputs and output reverse-polarity protected.

9) D = outputs overcurrent and short-circuit protected.

Safety-related parameters

MTTF_D	1,107.1 years
DC_{avg}	0 %

Classifications

ECLASS 5.0	27270901
ECLASS 5.1.4	27270901
ECLASS 6.0	27270901
ECLASS 6.2	27270901
ECLASS 7.0	27270901
ECLASS 8.0	27270901
ECLASS 8.1	27270901
ECLASS 9.0	27270901
ECLASS 10.0	27270901
ECLASS 11.0	27270901
ECLASS 12.0	27270901
ETIM 5.0	EC002716
ETIM 6.0	EC002716
ETIM 7.0	EC002716

ETIM 8.0	EC002716
UNSPSC 16.0901	39121528

Adjustments

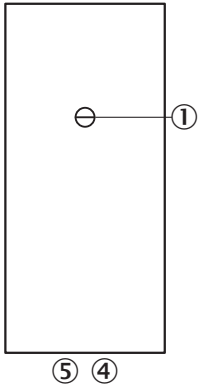

- ③ Sensitivity control 270°
- ④ LED indicator orange: switching output active
- ⑤ LED indicator green

Connection type



Connection diagram

Cd-060

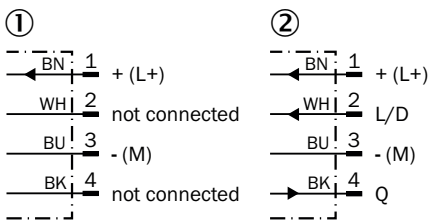

- ① Sender
- ② Receiver

Characteristic curve

VSE180-2, 25 m, radial

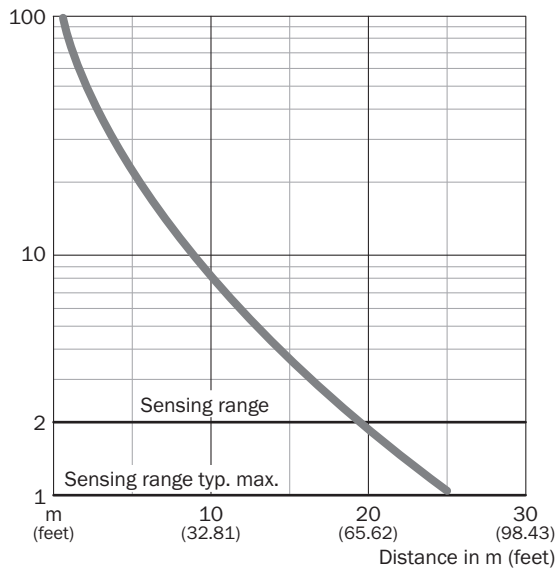

Light spot size

VSE180-2, 25 m, radial

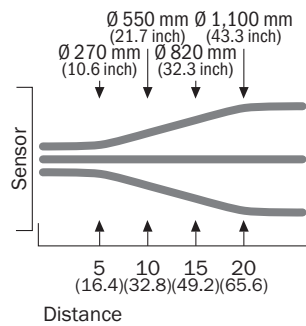

Sensing range diagram

VSE180-2, 25 m, radial

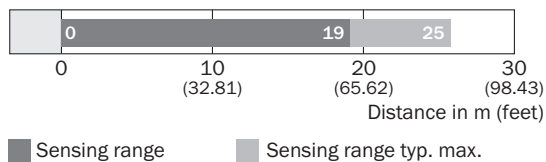

Dimensional drawing (Dimensions in mm (inch))

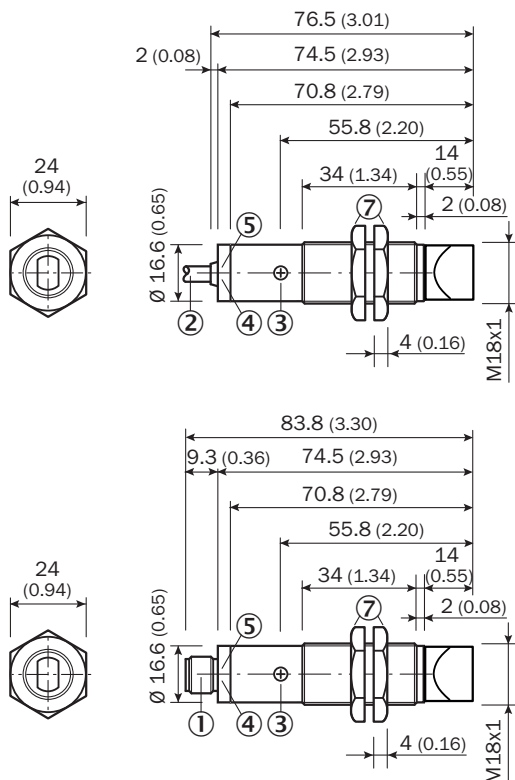

VSE180-2, metal, radial



- ① Connector M12, 3-pin / Connector M12, 3-pin
- ② Connection cable 2 m
- ③ Sensitivity control: potentiometer 270° (VE)
- ④ LED indicator orange: switching output active (only VE)
- ⑤ LED indicator green, stability indicator (only VE): LED lights continuously = light reception < 0.9/> 1.1; LED off = light reception > 0.9 / < 1.1
- ⑦ Metal housing, fastening nuts (2 x); width across 24

Recommended accessories

Other models and accessories → www.sick.com/V180-2

	Brief description	Type	Part no.
Others			
	<ul style="list-style-type: none"> • Connection type head A: Female connector, M12, 4-pin, straight, A-coded • Connection type head B: Flying leads • Signal type: Sensor/actuator cable • Cable: 5 m, 4-wire, PVC • Description: Sensor/actuator cable, unshielded • Application: Zones with chemicals 	YF2A14-050VB3XLEAX	2096235
	<ul style="list-style-type: none"> • Connection type head A: Male connector, M12, 4-pin, straight, A-coded • Description: Unshielded • Connection systems: Screw-type terminals • Permitted cross-section: ≤ 0.75 mm² 	STE-1204-G	6009932

SICK AT A GLANCE

SICK is one of the leading manufacturers of intelligent sensors and sensor solutions for industrial applications. A unique range of products and services creates the perfect basis for controlling processes securely and efficiently, protecting individuals from accidents and preventing damage to the environment.

We have extensive experience in a wide range of industries and understand their processes and requirements. With intelligent sensors, we can deliver exactly what our customers need. In application centers in Europe, Asia and North America, system solutions are tested and optimized in accordance with customer specifications. All this makes us a reliable supplier and development partner.

Comprehensive services complete our offering: SICK LifeTime Services provide support throughout the machine life cycle and ensure safety and productivity.

For us, that is “Sensor Intelligence.”

WORLDWIDE PRESENCE:

Contacts and other locations –www.sick.com