



VT18-2T1430

V18

CYLINDRICAL PHOTOELECTRIC SENSORS

SICK
Sensor Intelligence.



Ordering information

Type	Part no.
VT18-2T1430	6011374

Other models and accessories → www.sick.com/V18

Illustration may differ



Detailed technical data

Features

Functional principle	Photoelectric proximity sensor
Functional principle detail	Energetic
Dimensions (W x H x D)	18 mm x 18 mm x 92 mm
Housing design (light emission)	Cylindrical
Housing length	92 mm
Thread diameter (housing)	M18 x 1
Optical axis	Axial
Sensing range max.	2 mm ... 200 mm ¹⁾
Sensing range	3 mm ... 180 mm
Focus	Approx. 3.5°
Type of light	Infrared light
Light source	LED ²⁾
Light spot size (distance)	Ø 24 mm (200 mm)
Angle of dispersion	Approx. 3.5°
Adjustment	None

¹⁾ Object with 90% remission (based on standard white, DIN 5033).

²⁾ Average service life: 100,000 h at T_J = +25 °C.

Mechanics/electronics

Supply voltage U_B	20 V AC ... 253 V AC ¹⁾
Mains frequency	50 Hz, 60 Hz
Current consumption	30 mA ²⁾

¹⁾ Limit values.

²⁾ Without load.

³⁾ Depending on supply voltage VS.

⁴⁾ Signal transit time with resistive load.

⁵⁾ With light/dark ratio 1:1.

⁶⁾ C = interference suppression.

Switching output	TRIAC
Switching mode	Light switching
Output current I_{max.}	≤ 300 mA ³⁾
Response time	≤ 20 ms ⁴⁾
Switching frequency	25 Hz ⁵⁾
Connection type	Male connector M12, 4-pin
Circuit protection	C ⁶⁾
Protection class	III
Weight	30 g
Housing material	Plastic, PBT/PC
Optics material	Plastic, PMMA
Enclosure rating	IP67
Ambient operating temperature	-25 °C ... +70 °C
UL File No.	NMFT2.E175606

1) Limit values.

2) Without load.

3) Depending on supply voltage VS.

4) Signal transit time with resistive load.

5) With light/dark ratio 1:1.

6) C = interference suppression.

Classifications

ECLASS 5.0	27270903
ECLASS 5.1.4	27270903
ECLASS 6.0	27270903
ECLASS 6.2	27270903
ECLASS 7.0	27270903
ECLASS 8.0	27270903
ECLASS 8.1	27270903
ECLASS 9.0	27270903
ECLASS 10.0	27270904
ECLASS 11.0	27270904
ECLASS 12.0	27270903
ETIM 5.0	EC001821
ETIM 6.0	EC001821
ETIM 7.0	EC002719
ETIM 8.0	EC002719
UNSPSC 16.0901	39121528

Connection type

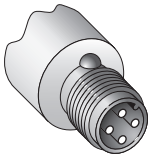

Connection diagram

Cd-129

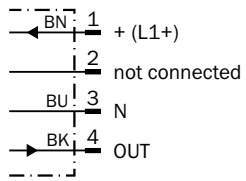

Characteristic curve

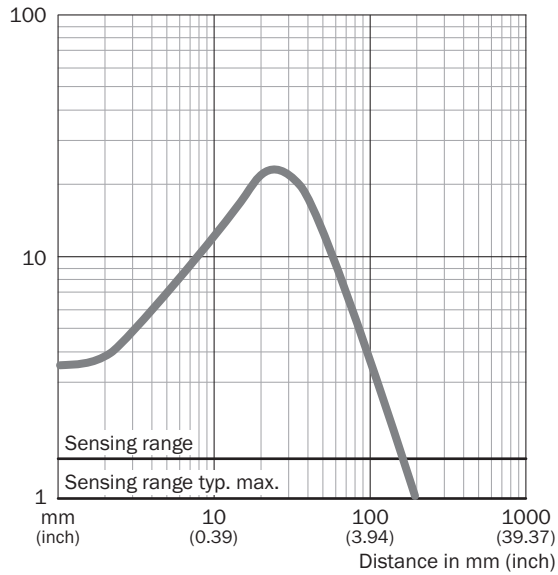

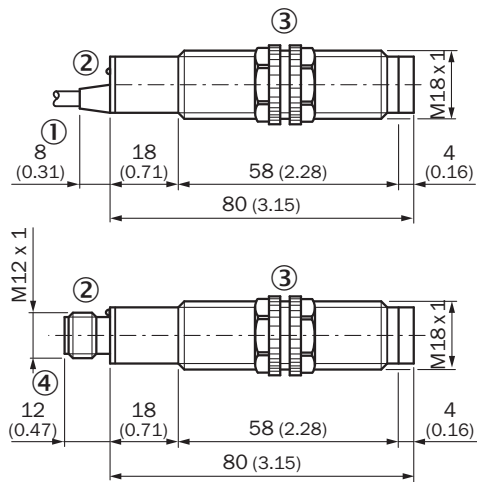

Dimensional drawing (Dimensions in mm (inch))



- ① Connection cable
- ② LED signal strength indicator
- ③ Fastening nuts, 22 mm hex (included)
- ④ Connector M12, 4-pin

Recommended accessories

Other models and accessories → www.sick.com/V18

	Brief description	Type	Part no.
Mounting brackets and plates			
	Mounting bracket for M18 sensors, steel, zinc coated, without mounting hardware	BEF-WN-M18	5308446
Others			
	<ul style="list-style-type: none"> • Connection type head A: Female connector, M12, 4-pin, straight, A-coded • Connection type head B: Flying leads • Signal type: Sensor/actuator cable • Cable: 5 m, 4-wire, PVC • Description: Sensor/actuator cable, unshielded • Application: Zones with chemicals 	YF2A14-050VB3XLEAX	2096235
	<ul style="list-style-type: none"> • Connection type head A: Male connector, M12, 4-pin, straight, A-coded • Description: Unshielded • Connection systems: Screw-type terminals • Permitted cross-section: ≤ 0.75 mm² 	STE-1204-G	6009932

SICK AT A GLANCE

SICK is one of the leading manufacturers of intelligent sensors and sensor solutions for industrial applications. A unique range of products and services creates the perfect basis for controlling processes securely and efficiently, protecting individuals from accidents and preventing damage to the environment.

We have extensive experience in a wide range of industries and understand their processes and requirements. With intelligent sensors, we can deliver exactly what our customers need. In application centers in Europe, Asia and North America, system solutions are tested and optimized in accordance with customer specifications. All this makes us a reliable supplier and development partner.

Comprehensive services complete our offering: SICK LifeTime Services provide support throughout the machine life cycle and ensure safety and productivity.

For us, that is “Sensor Intelligence.”

WORLDWIDE PRESENCE:

Contacts and other locations –www.sick.com