



WFS3-40P415

WFS

FORK SENSORS

SICK
Sensor Intelligence.



Ordering information

Type	Part no.
WFS3-40P415	6043919

Other models and accessories → www.sick.com/WFS

Illustration may differ



Detailed technical data

Features

Functional principle	Optical detection principle
Dimensions (W x H x D)	10 mm x 25 mm x 64.3 mm
Fork width	3 mm
Fork depth	42 mm
Minimum detectable object (MDO)	Gap between Labels / Size of labels: 2 mm ¹⁾
Label detection	✓
Adjustment	Plus/minus button, cable (Teach-in, sensitivity, light/dark switching, Teach-in dynamic)
Teach-in mode	2-point teach-in Teach-in dynamic

¹⁾ Depends on the label thickness.

Mechanics/electronics

Current consumption	20 mA ¹⁾
Stability of response time	± 20 µs
Jitter	40 µs
Switching output	PNP
Switching output (voltage)	PNP: HIGH = $U_V \leq 2 \text{ V}$ / LOW approx. 0 V
Switching mode	Light/dark switching
Output current I_{max}	100 mA
Input, teach-in (ET)	PNP Teach: $U > 5 \text{ V} \dots < U_V$ Run: $U < 4 \text{ V}$
Initialization time	20 ms
Connection type	Male connector M8, 4-pin
Circuit protection	U_V connections, reverse polarity protected Output Q short-circuit protected

¹⁾ Without load.

	Interference pulse suppression
Weight	Approx. 36 g
Housing material	Plastic, PA (glass-fiber reinforced)

¹⁾ Without load.

Safety-related parameters

MTTF_D	97 years
DC_{avg}	0 %

Ambient data

Shock load	According to EN 60068-2-27
UL File No.	NRKH.E191603

Classifications

ECLASS 5.0	27270909
ECLASS 5.1.4	27270909
ECLASS 6.0	27270909
ECLASS 6.2	27270909
ECLASS 7.0	27270909
ECLASS 8.0	27270909
ECLASS 8.1	27270909
ECLASS 9.0	27270909
ECLASS 10.0	27270909
ECLASS 11.0	27270909
ECLASS 12.0	27270909
ETIM 5.0	EC002720
ETIM 6.0	EC002720
ETIM 7.0	EC002720
ETIM 8.0	EC002720
UNSPSC 16.0901	39121528

Dimensional drawing (Dimensions in mm (inch))

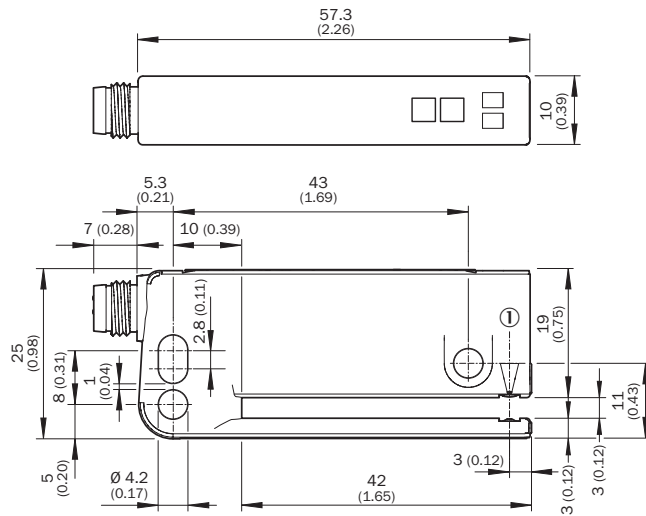

① Optical axis

Adjustments

Adjustment: teach-in via plus/minus buttons (WFxx-B416)

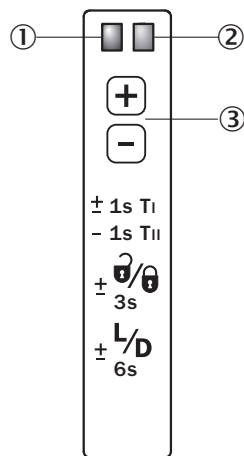

① Function signal indicator (yellow), switching output

② Function indicator (red)

③ “+”/“-” buttons and function button

Connection diagram

Cd-092

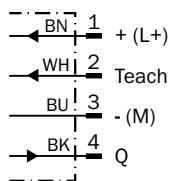

Concept of operation

1. Position label or substrate in the active area of the fork sensor

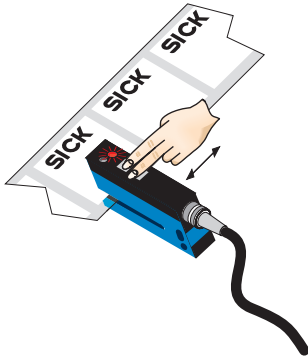

Press both the “+” and “-” buttons together, hold > 1 s and then release the teach-in buttons. The red LED flashes.

2. Move multiple labels through the fork sensor

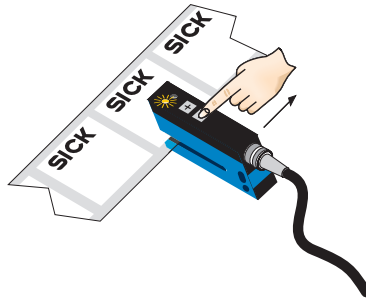

Press “-” button, teach-in process is finished.

Notes

Switching threshold adaptation:

Only, the first teach-in procedure after switching on is permanently stored. Teach-in can be repeated cyclically. Switching output also during teach-in active.

- + Once teach-in process is complete, the switching threshold can be adjusted at any time using the “+” or “-” button. To make minor adjustments, press the “+” or “-” button once. To configure settings quickly, keep the “+” or “-” button pressed for longer.



$\pm \frac{0}{3s}$ Press both the “+” and “-” buttons together (3 seconds) to lock the device and prevent unintentional actuation.



$\pm \frac{L}{6s}$ Press both the “+” and “-” buttons together (6 seconds) to define the switching function (light/dark switching). Standard setting: Q = light switching.

Teach-in (static): Setting the switching threshold without movements of label, cf. operating instruction.

Recommended accessories

Other models and accessories → www.sick.com/WFS

	Brief description	Type	Part no.
Universal bar clamp systems			
	WFS mounting rod, straight, including 2 x fixing screws, Aluminum	BEF-M12GF-A	2059414
	Bar clamp for bar diameter of 12 mm (fixing the mounting rod), Aluminum, 2 screws M6 x 30, 2 spring discs	BEF-RMC-D12	5321878

	Brief description	Type	Part no.
Others			
	<ul style="list-style-type: none"> • Connection type head A: Male connector, M8, 4-pin, straight • Description: Unshielded • Connection systems: Screw-type terminals • Permitted cross-section: 0.14 mm² ... 0.5 mm² 	STE-0804-G	6037323
	<ul style="list-style-type: none"> • Connection type head A: Female connector, M8, 4-pin, straight, A-coded • Connection type head B: Flying leads • Signal type: Sensor/actuator cable • Cable: 5 m, 4-wire, PVC • Description: Sensor/actuator cable, unshielded • Application: Zones with chemicals 	YF8U14-050VA3XLEAX	2095889

SICK AT A GLANCE

SICK is one of the leading manufacturers of intelligent sensors and sensor solutions for industrial applications. A unique range of products and services creates the perfect basis for controlling processes securely and efficiently, protecting individuals from accidents and preventing damage to the environment.

We have extensive experience in a wide range of industries and understand their processes and requirements. With intelligent sensors, we can deliver exactly what our customers need. In application centers in Europe, Asia and North America, system solutions are tested and optimized in accordance with customer specifications. All this makes us a reliable supplier and development partner.

Comprehensive services complete our offering: SICK LifeTime Services provide support throughout the machine life cycle and ensure safety and productivity.

For us, that is “Sensor Intelligence.”

WORLDWIDE PRESENCE:

Contacts and other locations –www.sick.com