



WL280-2H1531

W280-2

COMPACT PHOTOELECTRIC SENSORS

SICK
Sensor Intelligence.



Illustration may differ



Ordering information

Type	Part no.
WL280-2H1531	6044739

Included in delivery: BEF-W280 (1), P250 (1)

Other models and accessories → www.sick.com/W280-2

Detailed technical data

Features

Functional principle	Photoelectric retro-reflective sensor
Functional principle detail	With minimum distance to reflector (dual lens system)
Dimensions (W x H x D)	23.5 mm x 74.5 mm x 63 mm
Housing design (light emission)	Rectangular
Sensing range max.	0.01 m ... 15 m ¹⁾ 0.01 m ... 12 m ²⁾
Sensing range	0.01 m ... 13 m ¹⁾ 0.01 m ... 11 m ²⁾
Type of light	Visible red light
Light source	LED ³⁾
Light spot size (distance)	Ø 260 mm (8 m)
Adjustment	Potentiometer

¹⁾ Reflector PL80A.

²⁾ Reflector P250.

³⁾ Average service life: 100,000 h at T_U = +25 °C.

Mechanics/electronics

Supply voltage U_B	24 V DC ... 240 V DC ¹⁾ 24 V AC ... 240 V AC ¹⁾
-------------------------------------	--

¹⁾ +/- 10%.

²⁾ Provide suitable spark suppression for inductive or capacitive loads.

³⁾ With light/dark ratio 1:1.

⁴⁾ Do not bend below 0 °C.

⁵⁾ A = V_S connections reverse-polarity protected.

⁶⁾ C = interference suppression.

⁷⁾ Rated voltage: 250 V AC/DC.

⁸⁾ In the case of a DC supply (relating to EN 61000-6-3) the length of cable between the supply source and the sensor must be < 30 m.

⁹⁾ The AC/DC devices (-2Rxxx only) comply with the Radio Safety Requirements for the industrial sector (Radio Safety Class A). They may cause radio interference if used in a residential area.

Power consumption	≤ 5 VA
Switching output	Relay, electrically isolated ²⁾
Output function	Change-over contacts
Switching mode	Light switching ²⁾
Switching current (switching voltage)	3 A (240 V AC) 3 A (30 V DC)
Response time	≤ 15 ms
Switching frequency	33 Hz ³⁾
Connection type	Cable, 5-wire, 2 m ⁴⁾
Cable material	Plastic, PVC
Conductor cross section	0.76 mm ²
Circuit protection	A ⁵⁾ C ⁶⁾
Protection class	II ⁷⁾
Overvoltage category	2
Weight	150 g
Polarisation filter	✓
Interference emission	EN 61000-6-3 (only -2Hxxxx) ⁸⁾
Housing material	Plastic, ABS
Optics material	Plastic, PMMA
Enclosure rating	IP66 IP67
Items supplied	Mounting bracket BEF-W280, Reflector P250
Electromagnetic compatibility (EMC)	EN 60947-5-2 EN 61000-6-3 (only -2Hxxxx) ^{9) 9)}
Ambient operating temperature	-25 °C ... +55 °C
Ambient temperature, storage	-40 °C ... +70 °C

1) +/- 10%.

2) Provide suitable spark suppression for inductive or capacitive loads.

3) With light/dark ratio 1:1.

4) Do not bend below 0 °C.

5) A = V_S connections reverse-polarity protected.

6) C = interference suppression.

7) Rated voltage: 250 V AC/DC.

8) In the case of a DC supply (relating to EN 61000-6-3) the length of cable between the supply source and the sensor must be < 30 m.

9) The AC/DC devices (-2Rxxxx only) comply with the Radio Safety Requirements for the industrial sector (Radio Safety Class A). They may cause radio interference if used in a residential area.

Safety-related parameters

MTTF_D	1,537 years
DC_{avg}	0 %

Classifications

ECLASS 5.0	27270902
ECLASS 5.1.4	27270902
ECLASS 6.0	27270902

WL280-2H1531 | W280-2

COMPACT PHOTOELECTRIC SENSORS

ECLASS 6.2	27270902
ECLASS 7.0	27270902
ECLASS 8.0	27270902
ECLASS 8.1	27270902
ECLASS 9.0	27270902
ECLASS 10.0	27270902
ECLASS 11.0	27270902
ECLASS 12.0	27270902
ETIM 5.0	EC002717
ETIM 6.0	EC002717
ETIM 7.0	EC002717
ETIM 8.0	EC002717
UNSPSC 16.0901	39121528

Dimensional drawing (Dimensions in mm (inch))

WTE280-2, WL280-2, AC/DC

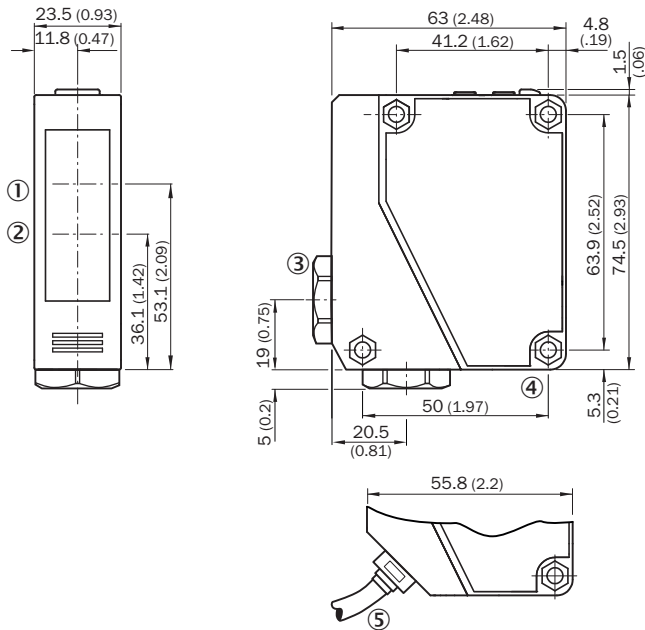

- ① Center of optical axis, receiver
- ② Center of optical axis, sender
- ③ Cable entry gland 3/8" for cable diameter 6 to 8 mm
- ④ Mounting hole, \varnothing 4.3 mm
- ⑤ Cable, 2 m, 5-wire, \varnothing 6.3 mm

Adjustments

WL280-2H/-2R

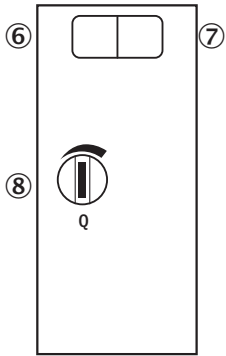

- ⑥ LED indicator green: Stability indicator
- ⑦ LED indicator yellow: Status of received light beam
- ⑧ Sensitivity control: potentiometer

Connection diagram

Cd-229

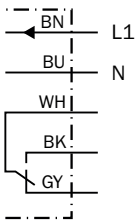

Characteristic curve

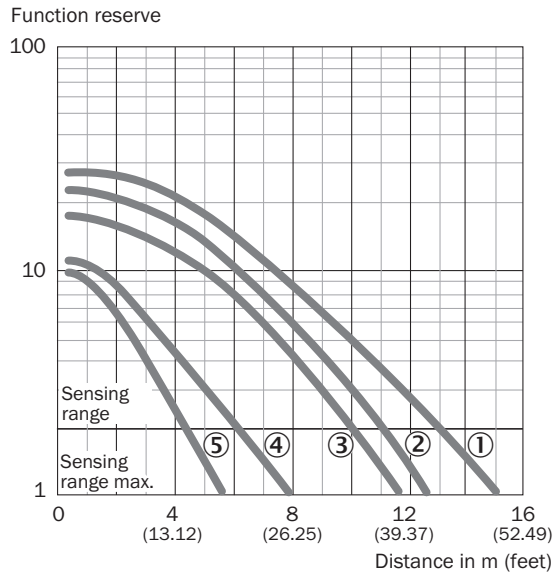

- ① Reflector PL80A, C110A
- ② Reflector P250
- ③ Reflector PL50A, PL40A, PL30A, PL31A
- ④ Reflector PL20A
- ⑤ Diamond Grade reflective tape, 100 mm x 100 mm

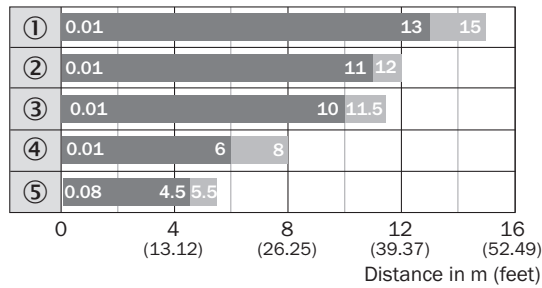

Sensing range diagram



- Sensing range ■ Sensing range max.
- ① Reflector PL80A, C110A
- ② Reflector P250
- ③ Reflector PL50A, PL40A, PL30A, PL31A
- ④ Reflector PL20A
- ⑤ Diamond Grade reflective tape, 100 mm x 100 mm

Recommended accessories

Other models and accessories → www.sick.com/W280-2

	Brief description	Type	Part no.
Mounting brackets and plates			
	Universal mounting bracket for reflectors, steel, zinc coated	BEF-WN-REFX	2064574
Reflectors			
	Rectangular, screw connection, 51 mm x 61 mm, PMMA/ABS, Screw-on, 2 hole mounting	P250	5304812
Others			
	<ul style="list-style-type: none"> • Connection type head A: Male connector, M12, 5-pin, straight, A-coded • Description: Unshielded, Head A: male connector, M12, 5-pin, straight, unshielded, for cable diameter 4 mm ... 6 mm Head B: - • Connection systems: Screw-type terminals • Permitted cross-section: ≤ 0.75 mm² • Note: For field bus technology 	STE-1205-G	6022083

SICK AT A GLANCE

SICK is one of the leading manufacturers of intelligent sensors and sensor solutions for industrial applications. A unique range of products and services creates the perfect basis for controlling processes securely and efficiently, protecting individuals from accidents and preventing damage to the environment.

We have extensive experience in a wide range of industries and understand their processes and requirements. With intelligent sensors, we can deliver exactly what our customers need. In application centers in Europe, Asia and North America, system solutions are tested and optimized in accordance with customer specifications. All this makes us a reliable supplier and development partner.

Comprehensive services complete our offering: SICK LifeTime Services provide support throughout the machine life cycle and ensure safety and productivity.

For us, that is “Sensor Intelligence.”

WORLDWIDE PRESENCE:

Contacts and other locations –www.sick.com