



# WL280-2H4331

W280-2

COMPACT PHOTOELECTRIC SENSORS

**SICK**  
Sensor Intelligence.



Illustration may differ



## Ordering information

Type	Part no.
WL280-2H4331	6044738

**Included in delivery:** BEF-W280 (1), P250 (1)

Other models and accessories → [www.sick.com/W280-2](http://www.sick.com/W280-2)

## Detailed technical data

### Features

<b>Functional principle</b>	Photoelectric retro-reflective sensor
<b>Functional principle detail</b>	With minimum distance to reflector (dual lens system)
<b>Dimensions (W x H x D)</b>	23.5 mm x 74.5 mm x 63 mm
<b>Housing design (light emission)</b>	Rectangular
<b>Sensing range max.</b>	0.01 m ... 15 m <sup>1)</sup> 0.01 m ... 12 m <sup>2)</sup>
<b>Sensing range</b>	0.01 m ... 13 m <sup>1)</sup> 0.01 m ... 11 m <sup>2)</sup>
<b>Type of light</b>	Visible red light
<b>Light source</b>	LED <sup>3)</sup>
<b>Light spot size (distance)</b>	Ø 260 mm (8 m)
<b>Adjustment</b>	Potentiometer

<sup>1)</sup> Reflector PL80A.

<sup>2)</sup> Reflector P250.

<sup>3)</sup> Average service life: 100,000 h at T<sub>J</sub> = +25 °C.

### Mechanics/electronics

<b>Supply voltage U<sub>B</sub></b>	24 V DC ... 240 V DC <sup>1)</sup> 24 V AC ... 240 V AC <sup>1)</sup>
<b>Power consumption</b>	≤ 5 VA

<sup>1)</sup> ± 10%.

<sup>2)</sup> Provide suitable spark suppression for inductive or capacitive loads.

<sup>3)</sup> With light/dark ratio 1:1.

<sup>4)</sup> A = V<sub>S</sub> connections reverse-polarity protected.

<sup>5)</sup> C = interference suppression.

<sup>6)</sup> Rated voltage: 250 V AC/DC.

<sup>7)</sup> In the case of a DC supply (relating to EN 61000-6-3) the length of cable between the supply source and the sensor must be < 30 m.

<sup>8)</sup> The AC/DC devices (-2Rxxx only) comply with the Radio Safety Requirements for the industrial sector (Radio Safety Class A). They may cause radio interference if used in a residential area.

<b>Switching output</b>	Relay, electrically isolated <sup>2)</sup>
<b>Output function</b>	Change-over contacts
<b>Switching mode</b>	Light switching <sup>2)</sup>
<b>Switching current (switching voltage)</b>	3 A (240 V AC) 3 A (30 V DC)
<b>Response time</b>	≤ 15 ms
<b>Switching frequency</b>	33 Hz <sup>3)</sup>
<b>Connection type</b>	Cable gland
<b>Circuit protection</b>	A <sup>4)</sup> C <sup>5)</sup>
<b>Protection class</b>	II <sup>6)</sup>
<b>Overvoltage category</b>	2
<b>Weight</b>	150 g
<b>Polarisation filter</b>	✓
<b>Interference emission</b>	EN 61000-6-3 (only -2Hxxxx) <sup>7)</sup>
<b>Housing material</b>	Plastic, ABS
<b>Optics material</b>	Plastic, PMMA
<b>Enclosure rating</b>	IP66 IP67
<b>Items supplied</b>	Mounting bracket BEF-W280, Reflector P250
<b>Electromagnetic compatibility (EMC)</b>	EN 60947-5-2 EN 61000-6-3 (only -2Hxxxx) <sup>8) 8)</sup>
<b>Ambient operating temperature</b>	-25 °C ... +55 °C
<b>Ambient temperature, storage</b>	-40 °C ... +70 °C

<sup>1)</sup> +- 10%.

<sup>2)</sup> Provide suitable spark suppression for inductive or capacitive loads.

<sup>3)</sup> With light/dark ratio 1:1.

<sup>4)</sup> A = V<sub>S</sub> connections reverse-polarity protected.

<sup>5)</sup> C = interference suppression.

<sup>6)</sup> Rated voltage: 250 V AC/DC.

<sup>7)</sup> In the case of a DC supply (relating to EN 61000-6-3) the length of cable between the supply source and the sensor must be < 30 m.

<sup>8)</sup> The AC/DC devices (-2Rxxxx only) comply with the Radio Safety Requirements for the industrial sector (Radio Safety Class A). They may cause radio interference if used in a residential area.

### Safety-related parameters

<b>MTTF<sub>D</sub></b>	1,537 years
<b>DC<sub>avg</sub></b>	0 %

### Classifications

<b>ECLASS 5.0</b>	27270902
<b>ECLASS 5.1.4</b>	27270902
<b>ECLASS 6.0</b>	27270902
<b>ECLASS 6.2</b>	27270902
<b>ECLASS 7.0</b>	27270902
<b>ECLASS 8.0</b>	27270902
<b>ECLASS 8.1</b>	27270902

# WL280-2H4331 | W280-2

## COMPACT PHOTOELECTRIC SENSORS

<b>ECLASS 9.0</b>	27270902
<b>ECLASS 10.0</b>	27270902
<b>ECLASS 11.0</b>	27270902
<b>ECLASS 12.0</b>	27270902
<b>ETIM 5.0</b>	EC002717
<b>ETIM 6.0</b>	EC002717
<b>ETIM 7.0</b>	EC002717
<b>ETIM 8.0</b>	EC002717
<b>UNSPSC 16.0901</b>	39121528

### Dimensional drawing (Dimensions in mm (inch))

WTE280-2, WL280-2, AC/DC

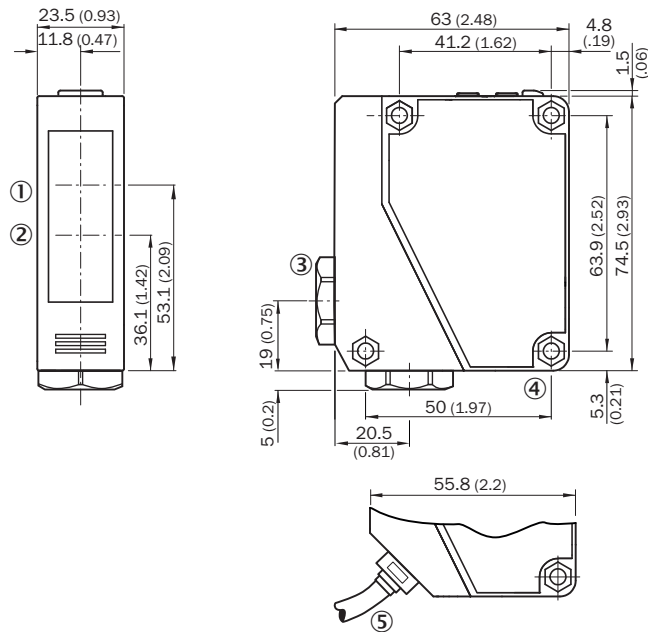

- ① Center of optical axis, receiver
- ② Center of optical axis, sender
- ③ Cable entry gland 3/8" for cable diameter 6 to 8 mm
- ④ Mounting hole, Ø 4.3 mm
- ⑤ Cable, 2 m, 5-wire, Ø 6.3 mm

## Adjustments

WL280-2H/-2R

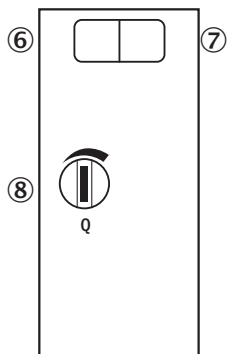

- ⑥ LED indicator green: Stability indicator
- ⑦ LED indicator yellow: Status of received light beam
- ⑧ Sensitivity control: potentiometer

## Connection diagram

Cd-239

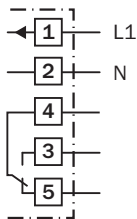

### Characteristic curve

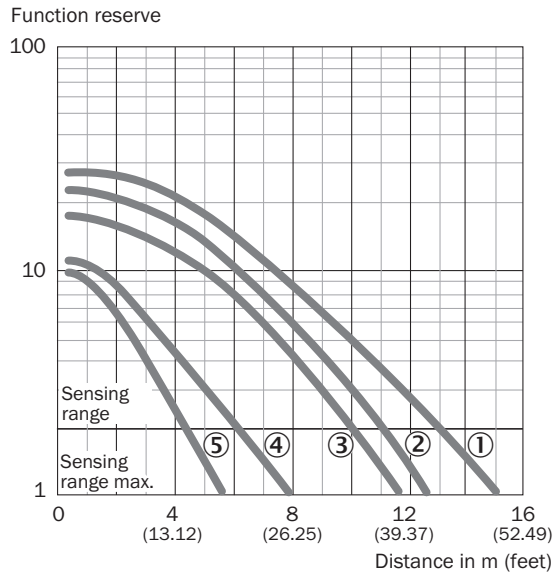

- ① Reflector PL80A, C110A
- ② Reflector P250
- ③ Reflector PL50A, PL40A, PL30A, PL31A
- ④ Reflector PL20A
- ⑤ Diamond Grade reflective tape, 100 mm x 100 mm

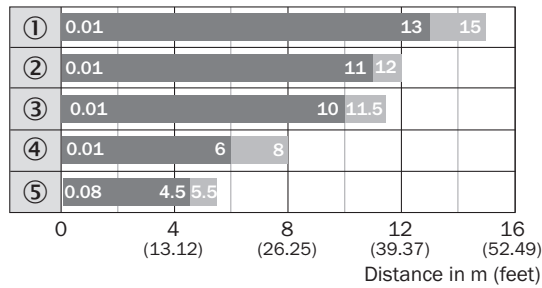

### Sensing range diagram



- Sensing range      ■ Sensing range max.
- ① Reflector PL80A, C110A
- ② Reflector P250
- ③ Reflector PL50A, PL40A, PL30A, PL31A
- ④ Reflector PL20A
- ⑤ Diamond Grade reflective tape, 100 mm x 100 mm

**Recommended accessories**

Other models and accessories → [www.sick.com/W280-2](http://www.sick.com/W280-2)

	<b>Brief description</b>	<b>Type</b>	<b>Part no.</b>
<b>Mounting brackets and plates</b>			
	Universal mounting bracket for reflectors, steel, zinc coated	BEF-WN-REFX	2064574
<b>Reflectors</b>			
	Rectangular, screw connection, 51 mm x 61 mm, PMMA/ABS, Screw-on, 2 hole mounting	P250	5304812

## SICK AT A GLANCE

SICK is one of the leading manufacturers of intelligent sensors and sensor solutions for industrial applications. A unique range of products and services creates the perfect basis for controlling processes securely and efficiently, protecting individuals from accidents and preventing damage to the environment.

We have extensive experience in a wide range of industries and understand their processes and requirements. With intelligent sensors, we can deliver exactly what our customers need. In application centers in Europe, Asia and North America, system solutions are tested and optimized in accordance with customer specifications. All this makes us a reliable supplier and development partner.

Comprehensive services complete our offering: SICK LifeTime Services provide support throughout the machine life cycle and ensure safety and productivity.

For us, that is “Sensor Intelligence.”

## WORLDWIDE PRESENCE:

Contacts and other locations –[www.sick.com](http://www.sick.com)