



# WL2S-2N3030S12

W2

MINIATURE PHOTOELECTRIC SENSORS

**SICK**  
Sensor Intelligence.



Illustration may differ



## Ordering information

Type	Part no.
WL2S-2N3030S12	1125199

**Included in delivery:** SCREW SET W2S/G2S (1)

Other models and accessories → [www.sick.com/W2](http://www.sick.com/W2)

## Detailed technical data

### Features

<b>Functional principle</b>	Photoelectric retro-reflective sensor
<b>Functional principle detail</b>	Without reflector minimum distance (autocollimation/coaxial optics)
<b>Dimensions (W x H x D)</b>	7.7 mm x 21.8 mm x 13.5 mm
<b>Housing design (light emission)</b>	Rectangular
<b>Sensing range max.</b>	0 m ... 1.2 m <sup>1)</sup>
<b>Sensing range</b>	0 m ... 0.55 m <sup>1)</sup>
<b>Type of light</b>	Visible red light
<b>Light source</b>	PinPoint LED <sup>2)</sup>
<b>Light spot size (distance)</b>	Ø 12 mm (250 mm)
<b>Wave length</b>	640 nm
<b>Adjustment</b>	None
<b>Special features</b>	Cable with special connector Typ 3M (37104-4101-G00 FL), 4-wire

<sup>1)</sup> Reflector P250F.

<sup>2)</sup> Average service life: 100,000 h at T<sub>J</sub> = +25 °C.

## Mechanics/electronics

<b>Supply voltage <math>U_B</math></b>	10 V DC ... 30 V DC <sup>1)</sup>
<b>Ripple</b>	< 5 V <sub>pp</sub> <sup>2)</sup>
<b>Current consumption</b>	20 mA <sup>3)</sup>
<b>Switching output</b>	NPN
<b>Switching mode</b>	Light/dark switching
<b>Output current <math>I_{max}</math></b>	≤ 50 mA
<b>Response time</b>	< 0.5 ms <sup>4)</sup>
<b>Switching frequency</b>	1,000 Hz <sup>5)</sup>
<b>Connection type</b>	Cable with special connector Typ 3M (37104-4101-G00 FL), 4-wire, 250 mm
<b>Cable material</b>	Plastic, PVC
<b>Conductor cross section</b>	0.09 mm <sup>2</sup>
<b>Cable diameter</b>	Ø 3 mm
<b>Circuit protection</b>	A <sup>6)</sup> B <sup>7)</sup> D <sup>8)</sup>
<b>Polarisation filter</b>	✓
<b>Housing material</b>	Plastic, ABS/PC
<b>Optics material</b>	Plastic, PMMA
<b>Enclosure rating</b>	IP67
<b>Ambient operating temperature</b>	-30 °C ... +50 °C
<b>Ambient temperature, storage</b>	-40 °C ... +75 °C
<b>UL File No.</b>	NRKH.E181493

<sup>1)</sup> Limit values.

<sup>2)</sup> May not fall below or exceed  $U_V$  tolerances.

<sup>3)</sup> Without load.

<sup>4)</sup> Signal transit time with resistive load.

<sup>5)</sup> With light/dark ratio 1:1.

<sup>6)</sup> A =  $V_S$  connections reverse-polarity protected.

<sup>7)</sup> B = output reverse-polarity protected.

<sup>8)</sup> D = outputs overcurrent and short-circuit protected.

## Safety-related parameters

<b>MTTF<sub>D</sub></b>	3,378 years
<b>DC<sub>avg</sub></b>	0 %

## Classifications

<b>ECLASS 5.0</b>	27270902
<b>ECLASS 5.1.4</b>	27270902
<b>ECLASS 6.0</b>	27270902
<b>ECLASS 6.2</b>	27270902
<b>ECLASS 7.0</b>	27270902
<b>ECLASS 8.0</b>	27270902
<b>ECLASS 8.1</b>	27270902

<b>ECLASS 9.0</b>	27270902
<b>ECLASS 10.0</b>	27270902
<b>ECLASS 11.0</b>	27270902
<b>ECLASS 12.0</b>	27270902
<b>ETIM 5.0</b>	EC002717
<b>ETIM 6.0</b>	EC002717
<b>ETIM 7.0</b>	EC002717
<b>ETIM 8.0</b>	EC002717
<b>UNSPSC 16.0901</b>	39121528

### Connection diagram

Cd-464

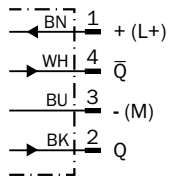

### Characteristic curve

WL2S-2

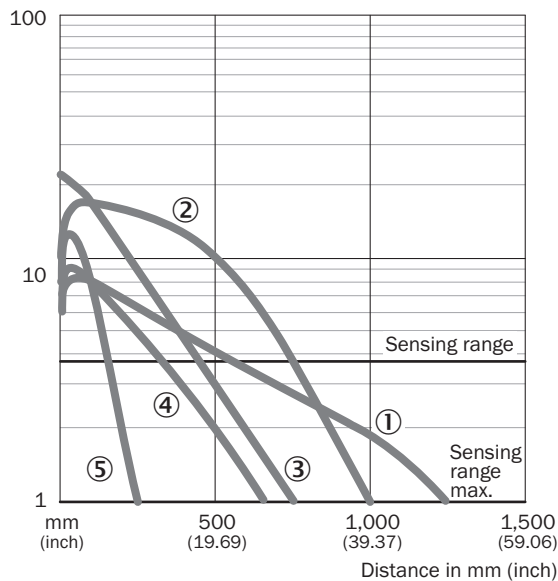

- ① Reflector P250F
- ② Reflector PL20F
- ③ Reflective tape REF-AC1000
- ④ PL10F reflector
- ⑤ Reflector PL8FH

Light spot size

WL2S-2

Spot diameter in mm (inch)

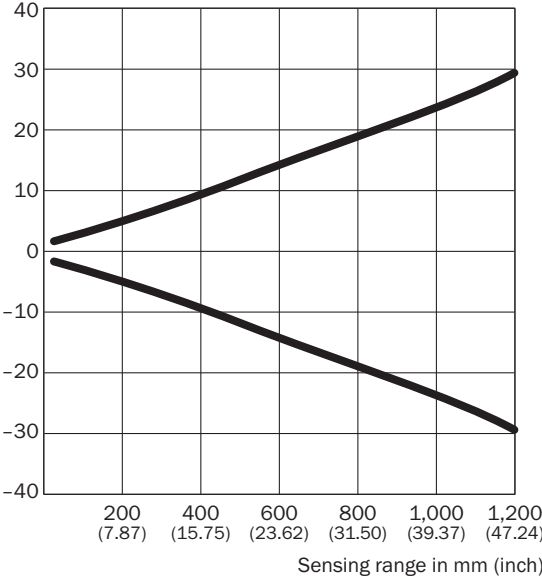

Dimensions in mm (inch)

Sensing range	Spot diameter
<b>20</b> (0.79)	3.4 (0.13)
<b>100</b> (3.94)	6.5 (0.26)
<b>250</b> (9.84)	12.0 (0.47)
<b>500</b> (19.69)	34.0 (1.34)
<b>1,000</b> (39.37)	48.0 (1.89)
<b>1,200</b> (47.24)	60.0 (2.36)

Sensing range diagram

WL2S-2

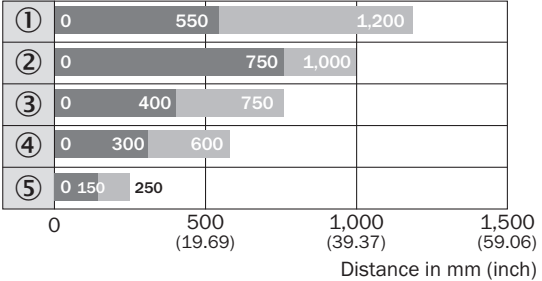

- Sensing range
- Sensing range max.
- ① Reflector P250F
- ② Reflector PL20F
- ③ Reflective tape REF-AC1000
- ④ PL10F reflector
- ⑤ Reflector PL8FH

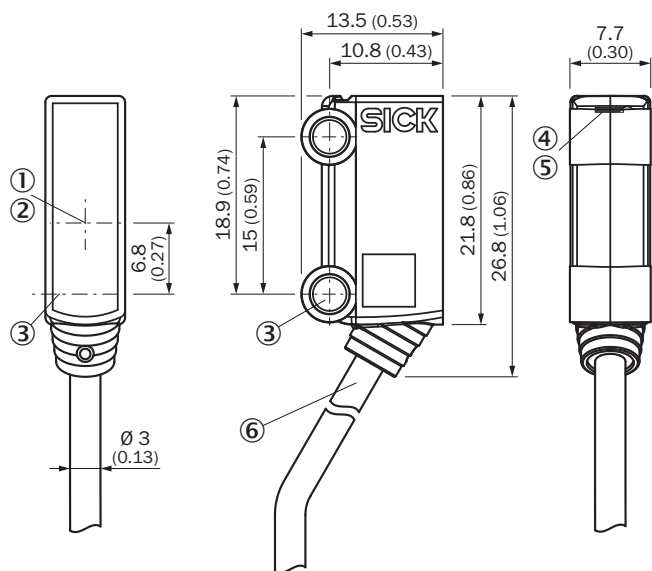

Dimensional drawing (Dimensions in mm (inch))



- ① Optical axis, receiver
- ② Optical axis, sender
- ③ Middle axis fixing hole Ø 3.2 mm
- ④ LED indicator green: Supply voltage active
- ⑤ LED indicator yellow: Status of received light beam
- ⑥ Cable with special connector 3M, 4-wire

Recommended accessories

Other models and accessories → [www.sick.com/W2](http://www.sick.com/W2)

	Brief description	Type	Part no.
<b>Reflectors</b>			
	Fine triple reflector, screw connection, suitable for laser sensors, 20 mm x 32 mm, PM-MA/ABS, Screw-on, 2 hole mounting	PL10F	5311210
<b>Others</b>			
	<ul style="list-style-type: none"> <li>• <b>Connection type head A:</b> Male connector, M8, 4-pin, straight, A-coded</li> <li>• <b>Description:</b> Unshielded</li> <li>• <b>Connection systems:</b> Screw-type terminals</li> <li>• <b>Permitted cross-section:</b> 0.14 mm<sup>2</sup> ... 0.5 mm<sup>2</sup></li> </ul>	STE-0804-G	6037323

## SICK AT A GLANCE

SICK is one of the leading manufacturers of intelligent sensors and sensor solutions for industrial applications. A unique range of products and services creates the perfect basis for controlling processes securely and efficiently, protecting individuals from accidents and preventing damage to the environment.

We have extensive experience in a wide range of industries and understand their processes and requirements. With intelligent sensors, we can deliver exactly what our customers need. In application centers in Europe, Asia and North America, system solutions are tested and optimized in accordance with customer specifications. All this makes us a reliable supplier and development partner.

Comprehensive services complete our offering: SICK LifeTime Services provide support throughout the machine life cycle and ensure safety and productivity.

For us, that is “Sensor Intelligence.”

## WORLDWIDE PRESENCE:

Contacts and other locations –[www.sick.com](http://www.sick.com)