



WL4SLC-3P2232A70

W4

MINIATURE PHOTOELECTRIC SENSORS

SICK
Sensor Intelligence.



Illustration may differ

Ordering information

Type	Part no.
WL4SLC-3P2232A70	1080947

The sensor is equipped with a special Smart Task function. Additional information can be found in the "Technical Data." Use of the sensor for pure object detection is limited.

Other models and accessories → www.sick.com/W4



Detailed technical data

Features

Functional principle	Photoelectric retro-reflective sensor
Functional principle detail	Without reflector minimum distance (autocollimation/coaxial optics)
Sensing range max.	0 m ... 12 m ¹⁾
Sensing range	0 m ... 8 m ¹⁾
Polarisation filters	Yes
Emitted beam	
Light source	Laser ²⁾
Type of light	Visible red light
Light spot size (distance)	Ø 1 mm (500 mm)
Key laser figures	
Normative reference	EN 60825-1:2014, IEC 60825-1:2014 / CDRH 21 CFR 1040.10 & 1040.11
Laser class	1
Wave length	650 nm
Adjustment	IO-Link, Single teach-in button
Special applications	Detecting small objects

¹⁾ Reflector PL80A.

²⁾ Average service life: 50,000 h at T_U = +25 °C.

Mounting hole	M3
Pin 2 configuration	External input, Teach-in input, Sender off input, Detection output, logic output, Device contamination alarm output

¹⁾ Reflector PL80A.

²⁾ Average service life: 50,000 h at $T_U = +25 \text{ °C}$.

Safety-related parameters

MTTF_D	562 years (EN ISO 13849-1) ¹⁾
DC_{avg}	0 %
T_M (mission time)	10 years

¹⁾ Mode of calculation: Parts-Count-calculation.

Communication interface

IO-Link	✓, COM2 (38,4 kBaud)
Data transmission rate	COM2 (38,4 kBaud)
Cycle time	2.3 ms
Process data length	16 Bit
Process data structure	Bit 0 = switching signal Q _{L1} Bit 1 = switching signal Q _{L2} Bit 2 ... 15 = measuring value
VendorID	26
DeviceID HEX	0x800111
DeviceID DEC	8388881

Electrical data

Supply voltage U_B	10 V DC ... 30 V DC ¹⁾
Ripple	< 5 V _{pp} ²⁾
Current consumption	30 mA ³⁾
Protection class	III
Digital output	
Type	PNP ^{4) 5)}
Switching mode	Light/dark switching ⁴⁾
Output current I _{max.}	≤ 100 mA
Response time	≤ 0,5 ms ⁶⁾
Repeatability (response time)	150 μs ⁷⁾

¹⁾ Limit values when operated in short-circuit protected network: max. 8 A.

²⁾ May not fall below or exceed U_y tolerances.

³⁾ Without load.

⁴⁾ Q = light switching.

⁵⁾ Pin 4: This switching output must not be connected to another output.

⁶⁾ Signal transit time with resistive load.

⁷⁾ Valid for Q \ on Pin2, if configured with software.

⁸⁾ With light/dark ratio 1:1.

⁹⁾ A = V_S connections reverse-polarity protected.

¹⁰⁾ B = inputs and output reverse-polarity protected.

¹¹⁾ C = interference suppression.

¹²⁾ With light / dark ratio 1:1, valid for Q \ on Pin2, if configured with software.

Switching frequency	1,000 Hz ⁸⁾
Output function	Complementary
Circuit protection	A ⁹⁾ B ¹⁰⁾ C ¹¹⁾
Response time Q/ on Pin 2	300 μs ... 450 μs ^{6) 7)}
Switching frequency Q / to pin 2	1,000 Hz ¹²⁾

- 1) Limit values when operated in short-circuit protected network: max. 8 A.
 2) May not fall below or exceed U_V tolerances.
 3) Without load.
 4) Q = light switching.
 5) Pin 4: This switching output must not be connected to another output.
 6) Signal transit time with resistive load.
 7) Valid for Q \ on Pin2, if configured with software.
 8) With light/dark ratio 1:1.
 9) A = V_S connections reverse-polarity protected.
 10) B = inputs and output reverse-polarity protected.
 11) C = interference suppression.
 12) With light / dark ratio 1:1, valid for Q \ on Pin2, if configured with software.

Mechanical data

Housing	Rectangular
Design detail	Slim
Dimensions (W x H x D)	12.2 mm x 41.8 mm x 17.3 mm
Connection	Male connector M8, 4-pin
Material	
	Housing Plastic, Novodur
	Front screen Plastic, PMMA
Weight	100 g

Ambient data

Enclosure rating	IP66 IP67
Ambient operating temperature	-10 °C ... +50 °C
Ambient operating temperature extended	-30 °C ... +55 °C ^{1) 2)}
Ambient temperature, storage	-30 °C ... +70 °C
UL File No.	NRKH.E181493

- 1) As of $T_a = 50$ °C, a max. supply voltage $V_{max.} = 24$ V and a max. load current $I_{max.} = 50$ mA is permitted.
 2) Operation below $T_u -10$ °C is possible if the sensor is already switched on at $T_u > -10$ °C, then cools down, and the supply voltage is subsequently not switched off. Switching on below $T_u -10$ °C is not permissible.

Smart Task

Smart Task name	Time measurement + debouncing
Logic function	Direct WINDOW

- 1) SIO Direct: sensor operation in standard I/O mode without IO-Link communication and without using internal sensor logic or time parameters (set to "direct"/"deactivated").
 2) SIO Logic: Sensor operation in standard I/O mode without IO-Link communication. Sensor-internal logic or timing parameters plus Automation Functions used.
 3) IOL: Sensor operation with full IO-Link communication and usage of logic, timing and Automation Function parameters.

Timer function	Deactivated Switch-on delay Off delay ON and OFF delay Impulse (one shot)
Inverter	Yes
Time measurement accuracy	SIO Direct: --- ¹⁾ SIO Logic: - 0,7 ... + 0,7 ms ± 0,5 % of time measurement value ²⁾ IOL: - 0,9 ... + 0,9 ms ± 0,5% of the time measurement ³⁾
Time measurement accuracy (e.g. accuracy for time measurement value = 1 s)	SIO Direct: --- ¹⁾ SIO Logic: - 5,7 ... + 5,7 ms ²⁾ IOL: - 5,9 ... + 5,9 ms ³⁾
Resolution time measuring value	1 ms
Min. Time between two process events (switches)	SIO Direct: --- SIO Logic: 450 µs IOL: 500 µs
Debounce time max.	SIO Direct: --- ¹⁾ SIO Logic: 30.000 ms ²⁾ IOL: 30.000 ms ³⁾
Switching signal	
Switching signal Q _{L1}	Output type (dependant on the adjusted threshold)
Switching signal Q _{L2}	Output type (dependant on the adjusted threshold)
Measuring value	Time measurement value

¹⁾ SIO Direct: sensor operation in standard I/O mode without IO-Link communication and without using internal sensor logic or time parameters (set to "direct"/"deactivated").

²⁾ SIO Logic: Sensor operation in standard I/O mode without IO-Link communication. Sensor-internal logic or timing parameters plus Automation Functions used.

³⁾ IOL: Sensor operation with full IO-Link communication and usage of logic, timing and Automation Function parameters.

Diagnosis

Device status	Yes
Quality of teach	Yes
Quality of run	Yes, Contamination display

Classifications

ECLASS 5.0	27270902
ECLASS 5.1.4	27270902
ECLASS 6.0	27270902
ECLASS 6.2	27270902
ECLASS 7.0	27270902
ECLASS 8.0	27270902
ECLASS 8.1	27270902
ECLASS 9.0	27270902
ECLASS 10.0	27270902
ECLASS 11.0	27270902
ECLASS 12.0	27270902
ETIM 5.0	EC002717
ETIM 6.0	EC002717

ETIM 7.0	EC002717
ETIM 8.0	EC002717
UNSPSC 16.0901	39121528

Connection diagram

Cd-367

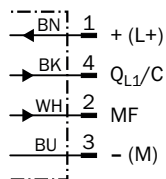

Characteristic curve

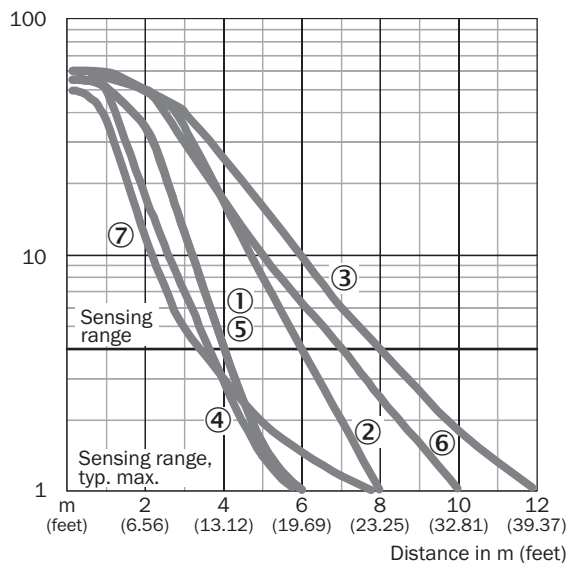

- ① Reflector PL20A
- ② Reflector PL40A
- ③ Reflector PL80A
- ④ PL10F reflector
- ⑤ Reflector PL20F
- ⑥ Reflector P250F
- ⑦ Reflective tape REF-AC1000

Light spot size

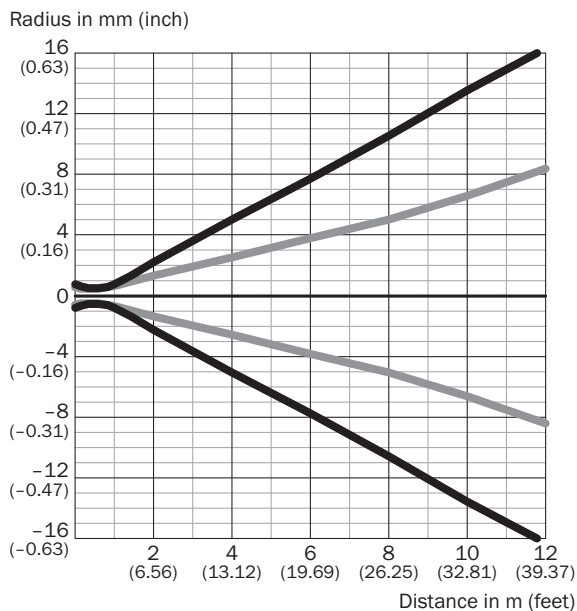

Dimensions in mm (inch)

Sensing range	Vertical	Horizontal
0.5 m (1.64 feet)	< 1.0 (0.04)	< 1.0 (0.04)
1 m (3.28 feet)	1.5 (0.06)	1.2 (0.05)
6 m (19.69 feet)	15.2 (0.60)	7.6 (0.30)
12 m (39.37 feet)	32.4 (1.28)	16.4 (0.65)

— Vertical
 — Horizontal

Light spot size (detailed view)

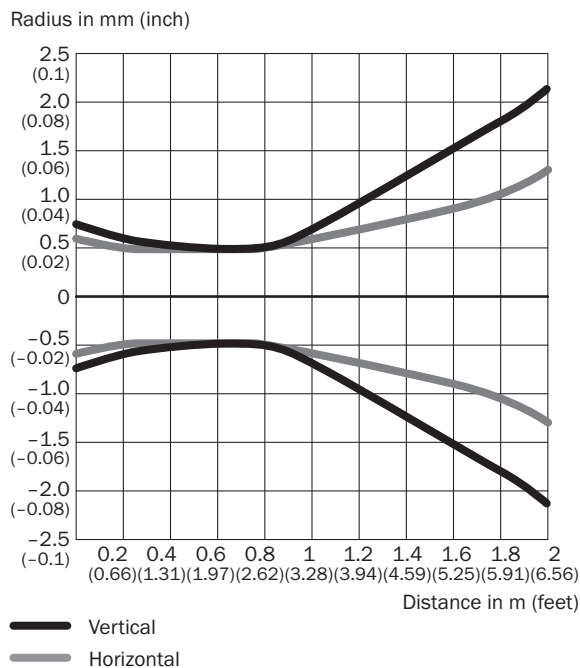

Sensing range diagram

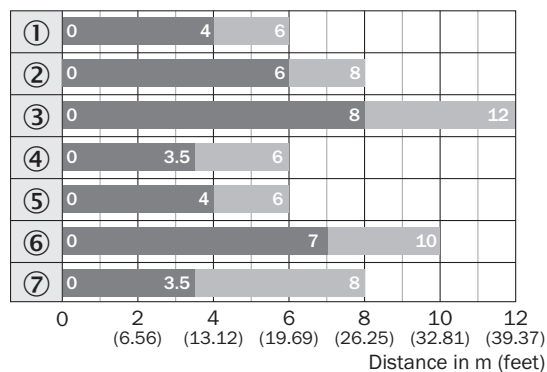

- Sensing range ■ Sensing range typ. max.
- ① Reflector PL20A
- ② Reflector PL40A
- ③ Reflector PL80A
- ④ PL10F reflector
- ⑤ Reflector PL20F
- ⑥ Reflector P250F
- ⑦ Reflective tape REF-AC1000

Dimensional drawing (Dimensions in mm (inch))

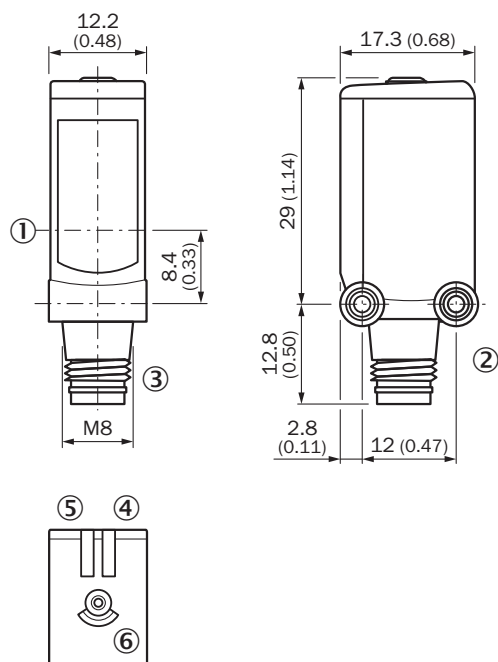

WL4SL-3, WL4SLG-3, WSE4SL-3, plug



- ① Center of optical axis
- ② Threaded mounting hole M3
- ③ Connection
- ④ LED indicator green: Supply voltage active
- ⑤ LED indicator yellow: Status of received light beam
- ⑥ Single teach-in button

Recommended accessories

Other models and accessories → www.sick.com/W4

	Brief description	Type	Part no.
Reflectors			
	Fine triple reflector, screw connection, suitable for laser sensors, 20 mm x 32 mm, PM-MA/ABS, Screw-on, 2 hole mounting	PL10F	5311210
Others			
	<ul style="list-style-type: none"> • Connection type head A: Female connector, M8, 4-pin, straight, A-coded • Connection type head B: Flying leads • Signal type: Sensor/actuator cable • Cable: 5 m, 4-wire, PVC • Description: Sensor/actuator cable, unshielded • Application: Zones with chemicals 	YF8U14-050VA3XLEAX	2095889
	<ul style="list-style-type: none"> • Connection type head A: Male connector, M8, 4-pin, straight, A-coded • Description: Unshielded • Connection systems: Screw-type terminals • Permitted cross-section: 0.14 mm² ... 0.5 mm² 	STE-0804-G	6037323

Recommended services

Additional services → www.sick.com/W4

	Type	Part no.
Function Block Factory		
<ul style="list-style-type: none"> • Description: The Function Block Factory supports common programmable logic controllers (PLCs) from various manufacturers, such as Siemens, Beckhoff, Rockwell Automation and B&R. More information on the FBF can be found <a _blank"="" href="https://fbf.cloud.sick.com target=">here. • Note: You can configure your function block at <a _blank"="" href="https://fbf.cloud.sick.com target=">Function Block Factory. As a login please use your SICK ID. 	Function Block Factory	On request

SICK AT A GLANCE

SICK is one of the leading manufacturers of intelligent sensors and sensor solutions for industrial applications. A unique range of products and services creates the perfect basis for controlling processes securely and efficiently, protecting individuals from accidents and preventing damage to the environment.

We have extensive experience in a wide range of industries and understand their processes and requirements. With intelligent sensors, we can deliver exactly what our customers need. In application centers in Europe, Asia and North America, system solutions are tested and optimized in accordance with customer specifications. All this makes us a reliable supplier and development partner.

Comprehensive services complete our offering: SICK LifeTime Services provide support throughout the machine life cycle and ensure safety and productivity.

For us, that is “Sensor Intelligence.”

WORLDWIDE PRESENCE:

Contacts and other locations –www.sick.com